



GENERAL
CATALOGUE

movimiento continuo desde 1976
continuous movement since 1976





BOMBAS SACI S.A. somos una empresa española **con más de 40 años de historia**. Fundada en Barcelona en el año 1976, en el año 2019 inauguramos nuestra nueva fábrica localizada en Granollers donde disponemos de unas instalaciones de más de 8.000 m² que junto a nuestra delegación de A Coruña y Levante, nos permiten garantizar y optimizar el nivel de servicio logístico y de producción a toda nuestra red de clientes nacionales e internacionales.

A día de hoy **estamos presentes en más de 85 países**. Nuestro reto es desarrollar y reforzar nuestra presencia alrededor del mundo, posicionando nuestra marca al más alto nivel en cuanto a Calidad, Innovación y Servicio.

Ponemos nuestro empeño en todo lo que hacemos priorizando el respeto por el medio ambiente, es por ello que la gran mayoría de **nuestros nuevos productos son de carácter Eco-Friendly**, optimizando el consumo energético para maximizar el respeto al medio ambiente.

Es también nuestra responsabilidad mantener como reto fundamental generar el mínimo impacto ambiental en emisiones tanto de nuestros productos como de nuestros procesos de fabricación. Es por ello que en nuestra nueva fábrica de Granollers hemos implementado un nuevo sistema de generación de energía renovable solar fotovoltaica, que nos permite prácticamente ser autosuficientes en cuanto a nuestras necesidades energéticas.



Saci
pumps



SACI PUMPS is a Spanish company with **more than 40 years of history**. Founded in Barcelona in 1976, in 2019 we inaugurated our new factory located in Granollers where we have facilities of more than 8,000 m², that together with our delegation from A Coruña and Levante, allow us to guarantee and optimize the level of logistic service and production to our entire network of national and international customers.

Today we are **present in more than 85 countries**. Our challenge is to develop and strengthen our presence around the world, positioning our brand at the highest level in terms of Quality, Innovation and Service.

We put our effort into everything we do, prioritizing respect for the environment. Which is why the vast majority of **our new products are Eco-Friendly**, optimizing energy consumption to maximize respect for the environment.

It is also our responsibility to maintain as a fundamental challenge to generate the minimum environmental impact in emissions of both our products and our manufacturing processes, that is why in our new Granollers Factory we have implemented a new renewable photovoltaic solar energy generation system, which it allows us to be practically self-sufficient in terms of our energy needs.



INNOVACIÓN

innovation

ES

Innovadores por excelencia. Pioneros en innovaciones dentro de nuestro sector, algunos de los equipos que hemos desarrollado son actualmente referentes del mercado a nivel internacional, tanto en bombas como en sistemas de optimización de eficiencia energética y control de instalaciones, fabricando algunas de las novedades más revolucionarias del mercado como nuestra bomba MAGNUS para piscina pública a 1450 rpm, de hasta 15CV de potencia, nuestra gama de **variadores de frecuencia [e]MOTION, [e]JOY y [e]POOL**, o el sistema de control integral para bombas **SMART POOL, SMART PRO** e **EASYTRONIC**, transformándose en auténticos referentes a nivel internacional así como también por la mejora continua de toda nuestra gama de productos.

Todo ello desarrollado internamente a través de nuestro **propio departamento de I+D+I** un elemento fundamental en el espíritu de nuestra organización.

EN

Innovators par excellence. *Pioneers in innovations within our sector, some of the equipment we have developed are currently the international market benchmarks, both in pumps and in systems for optimizing energy efficiency and control of facilities, manufacturing some of the most revolutionary novelties on the market such as our MAGNUS pump for public swimming pool at 1450 rpm, up to 15HP of power, our range of **frequency inverters [e]MOTION, [e]JOY and [e]POOL**, or the integrated control system for pumps **SMART POOL, SMART PRO** and **EASYTRONIC**, transforming itself into true international benchmarks as well as also for the continuous improvement of our entire range of products.*

*All this developed internally through **our own R+D+I department**, a fundamental element in the spirit of our organization.*



CALIDAD

quality

La calidad de todos nuestros productos es uno de los valores clave de Bombas Saci.

Todos los materiales y componentes que utilizamos son de la más alta calidad y de procedencia Nacional y Europea, aun así, hemos implementado un **estricto control automático de TEST** al final de todas nuestras líneas de producción, que **verifica el 100% de nuestra producción**, de manera que somos capaces de certificar el estándar de calidad más elevado y garantizar así la total satisfacción de nuestros clientes.

The quality of all our products is one of the key values of Saci Pumps.

*All the materials and components that we use are of the highest quality and of National and European origin, even so, we have implemented a **strict automatic TEST control** at the end of all our production lines, which **verifies 100% of our production**, of way we are able to certify the highest quality standard and thus guarantee the total satisfaction of our customers.*



SERVICIO AL CLIENTE

customer service

La atención al cliente y su satisfacción es nuestro mayor objetivo.

Toda nuestra organización está orientada a **resolver de forma INMEDIATA cualquier consulta o solicitud** por parte de nuestros clientes.

Fabricamos contra STOCK, y disponemos de un muy elevado **nivel de existencias que cubre cerca del 90%** de nuestro catálogo para expedición inmediata.

Gracias a nuestros servicios Logísticos, el 92% de nuestras expediciones diarias nacionales se entregan en cualquier punto de la península ibérica en tan solo **24h desde la recepción del pedido**. En expediciones internacionales tenemos compromiso de expedición en tiempos similares a las expediciones nacionales.

The customer service and your satisfaction is our main objective.

*Our entire organization is oriented to **solve IMMEDIATELY any query or request** from our clients.*

*We manufacture against **STOCK**, and we have a very **high level of stock that covers about 90%** of our catalog for immediate shipment.*

*Thanks to our logistics services, 92% of our national daily shipments are delivered anywhere in the Iberian Peninsula in just **24 hours from the receipt of the order**. In international shipments we have shipment commitment in times similar to national shipments.*



ECO-FRIENDLY

eco-friendly

¡El respeto por el medio ambiente nos importa mucho! Nuestro departamento de desarrollo trabaja cada día para reducir el consumo eléctrico de los equipos que fabricamos, y todo esto sin perder sus prestaciones. La nueva línea ECO-FRIENDLY que hemos desarrollado nos permiten **ahorrar hasta un 80% de energía**.

Estamos orientados en el respeto y preservación del medio ambiente y la sustentabilidad de las generaciones futuras, por eso invertimos todos los recursos necesarios para fabricar equipos **capaces de optimizar el consumo energético y reducir las emisiones de CO₂**.

Además, estamos muy implicados en la reducción de emisiones y consumo energético en todos nuestros procesos internos como fabricación, logística y transformación.

***Respect for the environment matters a lot to us!** Our development department works every day to reduce the electrical consumption of the equipment we manufacture, and all this without losing its benefits. The new ECO-FRIENDLY line that we have developed allows us to **save up to 80% of energy**.*

*We are focused on respecting and preserving the environment and the sustainability of future generations, that's why we invest all the necessary resources to manufacture **equipment capable of optimizing energy consumption and reducing CO₂ emissions**.*

In addition, we are very involved in the reduction of emissions and energy consumption in all our internal processes such as manufacturing, logistics and transformation.

ES

EN

Certificado ES19/86640

SGS

El sistema de gestión de

BOMBAS SACI, S.A.

C/ Can Muntanyola, 4-22, P.I. Palou Nord
08401 Granollers (Barcelona)

ha sido evaluado y certificado en cuanto al cumplimiento de los requisitos de

ISO 9001:2015

Para las siguientes actividades

**Diseño, montaje y comercialización de bombas hidráulicas,
equipos de presión, sistemas de abastecimiento de agua
contraincendios y sistemas de control y protección
para equipos de bombeo.**

en/desde los siguientes emplazamientos

C/ Can Muntanyola, 4-22, P.I. Palou Nord - 08401 Granollers (Barcelona)

Este certificado es válido desde
28 de octubre de 2020 hasta 17 de octubre de 2022.
Edición 2. Certificado con SGS desde octubre de 2019.



Autorizado por

Dirección de Certificación

SGS INTERNATIONAL CERTIFICATION SERVICES IBERICA, S.A.U.
C/Trespademe, 29. 28042 Madrid, España.
t 34 91 313 8115 f 34 91 313 8102 www.sgs.com

Página 1 de 1



Este documento se emite por SGS bajo sus condiciones generales de servicio, a las que se puede acceder en http://www.sgs.com/temas_ani_condiions.htm. La responsabilidad de SGS queda limitada en los términos establecidos en las citadas condiciones generales que resultan de aplicación a la prestación de sus servicios. La autenticidad de este documento puede ser comprobada en <http://www.sgs.com/en/certified-client-and-products/certified-client-directory>. El presente documento no podrá ser alterado ni modificado, ni en su contenido ni en su apariencia. En caso de modificación del mismo, SGS se reserva las acciones legales que estime oportunas para la defensa de sus legítimos intereses.

SGS

Certificado ES19/86639

El sistema de gestión de

BOMBAS SACI, S.A.

C/ Can Muntanyola, 4-22, P.I. Palou Nord
08401 Granollers (Barcelona)

ha sido evaluado y certificado en cuanto al cumplimiento de los requisitos de

ISO 14001:2015

Para las siguientes actividades

**Diseño, montaje y comercialización de bombas hidráulicas,
equipos de presión, sistemas de abastecimiento de agua
contraincendios y sistemas de control y protección
para equipos de bombeo.**

en/desde los siguientes emplazamientos

C/ Can Muntanyola, 4-22, P.I. Palou Nord - 08401 Granollers (Barcelona)

Este certificado es válido desde
28 de octubre de 2020 hasta 17 de octubre de 2022.
Edición 2. Certificado con SGS desde octubre de 2019.

Autorizado por

Dirección de Certificación

SGS INTERNATIONAL CERTIFICATION SERVICES IBERICA, S.A.U.
C/Trespaderne, 29. 28042 Madrid. España.
t 34 91 313 8115 f 34 91 313 8102 www.sgs.com

Página 1 de 1

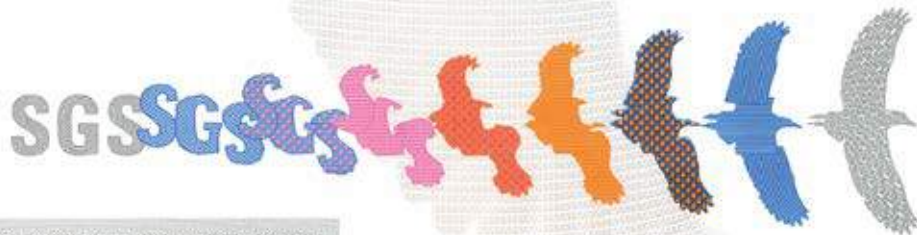

Este documento se emite por SGS bajo sus condiciones generales de servicio, a las que se puede acceder en http://www.sgs.com/terms_and_conditions.htm. La responsabilidad de SGS queda limitada en los límites establecidos en las citadas condiciones generales que resultan de aplicación a la prestación de sus servicios. La autenticidad de este documento puede ser comprobada en <http://www.sgs.com/certified-clients-and-product/certified-client-directory>. El presente documento no podrá ser alterado ni modificado, ni en su contenido ni en su apariencia. En caso de modificación del mismo, SGS se reserva las acciones legales que estime oportunas para la defensa de sus legítimos intereses.

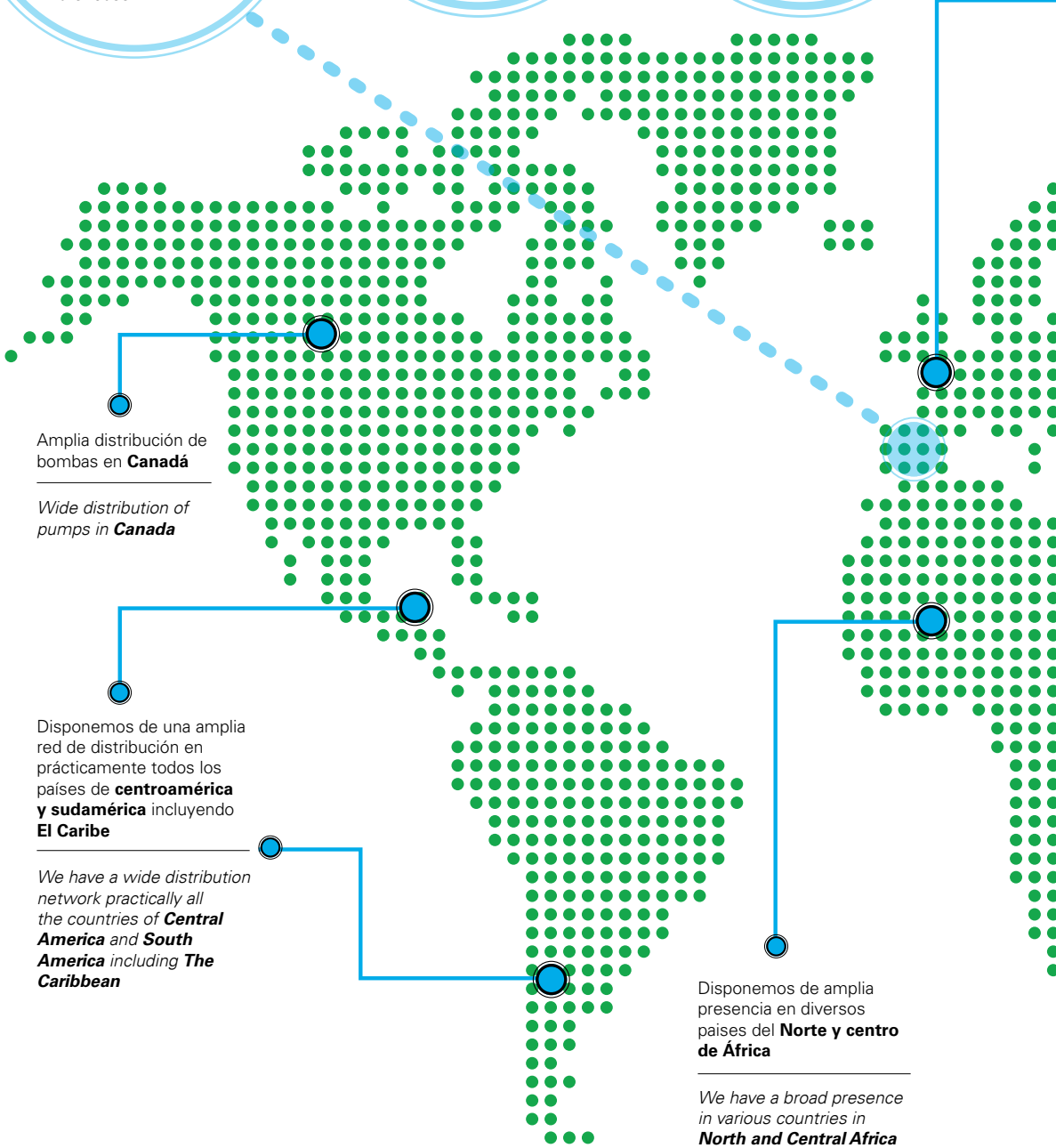
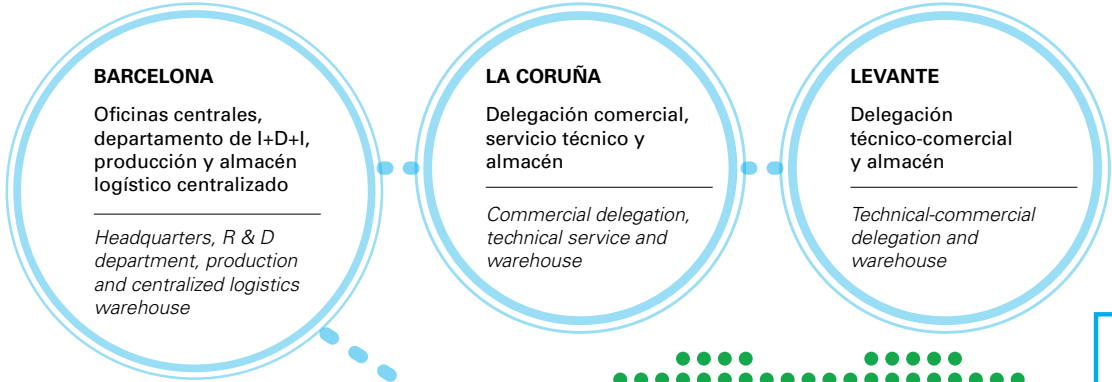

ACTUALMENTE DISTRIBUIMOS EN MÁS DE 85 PAÍSES DE LOS 5 CONTINENTES
 CURRENTLY WE DISTRIBUTE IN MORE THAN 85 COUNTRIES OF THE 5 CONTINENTS

Estamos presentes en todos los países de **Europa** mediante una amplísima red de distribución

*We are present in all **European** countries through a wide distribution network*

Podéis encontrar nuestros productos en prácticamente todos los países de **Oriente Medio**

*You can find our products in almost all the countries of the **Middle East***

En **Asia** tenemos presencia en multitud de países como **Rusia, Japón, Vietnam, Indonesia, y Tailandia**

*In **Asia** we have presence in many countries such as **Russia, Japan, Vietnam, Indonesia, and Thailand***

En **Australia** disponemos de varios distribuidores que cubren todo el país

*In **Australia** we have several distributors that cover the whole country*

En **India** disponemos de distribuidores para nuestra gama de bombas

*In **India** we have distributors for our range of pumps*

Nuestra red de distribución incluye **Islas Mauricio e Islas Seychelles**

*Our distribution network includes **Mauritius and Seychelles***



12

USO DOMÉSTICO
DOMESTIC USE

DOMESTIC USE

24

PISCINAS, FILTROS
WELLNESS
*SWIMMING POOLS
FILTERS, WELLNESS*

SWIMMING POOLS
FILTERS, WELLNESS

63

CENTRÍFUGAS VERTICALES
Y HORIZONTALES
*VERTICAL AND HORIZONTAL
CENTRIFUGALS*

VERTICAL AND HORIZONTAL
CENTRIFUGALS

102

SUMERGIBLES
SUBMERSIBLE

SUBMERSIBLE

137

CONTROL
Y PROTECCIÓN
*CONTROL
AND PROTECTION*

CONTROL AND
PROTECTION

150

EQUIPOS PRESIÓN
Y CONTRAINCENDIOS
*BOOSTER SETS AND
FIRE FIGHTING UNITS*

BOOSTER SETS AND
FIRE FIGHTING UNITS

162

CIRCULADORAS
CIRCULATORS

CIRCULATORS

192

OTROS USOS
Y ACCESORIOS
*OTHER USES
AND ACCESSORIES*

OTHER USES AND
ACCESSORIES



PRESIÓN DOMÉSTICA

SUPERFICIE

14 **SIGMA**

16 **JET**

17 **AP**

18 **PE**

SUMERGIBLES

19 **DIVERTECH**

20 **DIVERMATIC**

21 **NOVA
FEKA**

22 **MINI DRX**

23 **FUENTES Y ACUARIOS
FOUNTAINS AND AQUARIUMS**

SIGMA



Disponible con
AUTOPRESS
AUTOPRESS also
available



Aplicaciones:

Las bombas horizontales multicelulares de la serie SIGMA, por su elevado rendimiento y funcionamiento **EXTREMADAMENTE SILENCIOSO**, son especialmente indicadas para su uso en equipos de presión, tanto de uso domestico como industriales.

Características Constructivas:

Turbinas y camisa en acero inoxidable AISI-304.
Difusores en tecnopolímero inyectado con fibra de vidrio.
Cuerpo aspiración e impulsión en fundición GG-20.
Eje en acero inoxidable AISI-431.
Cierre mecánico en cerámica grafito y AISI-304.

Motor:

Motor asíncrono, cerrado de ventilación externa, apto para trabajo continuo. Grado de protección IP-55, aislamiento clase F (calentamiento "B").

PUEDE SUMINISTRARSE BAJO DEMANDA CON EL REGULADOR DE PRESIÓN MODELO SACIPRESS O AUTOPRESS.

MAXIMA TEMPERATURA AGUA: +35° C
MAXIMA TEMPERATURA AMBIENTE: +45° C



Applications:

The multistage horizontal pumps SIGMA series, through their high output and **EXTREMELY SILENT** operation, are particularly recommended for the use in domestic and industrial pressuring systems.

Constructive characteristics:

Impellers and sleeve in stainless steel AISI-304.
Shaft in stainless steel AISI- 431.
Diffusers injected with fiber glass.
Inlet and outlet body in cast iron GG-20.
Mechanical seal in graphite ceramic and Stainless steel AISI-304.

Motor:

Motor asíncrono, cerrado de ventilación externa, apto para trabajo continuo. Grado de protección IP-55, aislamiento clase F (calentamiento "B").

CAN BE PROVIDED UNDER DEMAND WITH THE PRESSURE REGULATOR TYPE SACIPRESS OR AUTOPRESS.

MAXIMUM WATER TEMPERATURE: +35° C
MAXIMUM AMBIENT TEMPERATURE: +45° C

Tipo Type	Potencia		"A"			Cond. μf	Caudal m^3/h / Flow m^3/h								Diámetro		
			II 230	III 230	III 400		0	0,5	1	1,5	2	2,5	3	3,5	4	ASP.	IMP.
	HP	KW	Altura m.c.a. / Height w.c.m.														
SIGMA 102 M	0,33	0,25	2	-	-	12	23	22	20	18	15	12	9	6	1	1"	1"
SIGMA 103 M	0,5	0,37	3,4	-	-	12	34	33	31	27	23	19	14	8	1,5	1"	1"
SIGMA 104 M	0,75	0,55	4,2	-	-	12	45	44	41	36	31	25	18	11	2	1"	1"
SIGMA 105 M/T	1	0,75	4,7	3,6	2,1	12	56	55	51	45	38	31	23	14	3	1"	1"

Tipo Type	Potencia		"A"			Cond. μf	Caudal m^3/h / Flow m^3/h							Diámetro		
			II 230	III 230	III 400		0	1	2	3	4	5	6	7	ASP.	IMP.
	HP	KW	Altura m.c.a. / Height w.c.m.													
SIGMA 202 M	1	0,75	4,7	-	-	12	23	22	21	20	18	16	13	9	1"	1"
SIGMA 203 M	1	0,75	5,5	-	-	12	34	33	32	30	27,5	24	19	13	1"	1"
SIGMA 204 M	1,2	0,9	6,8	-	-	20	44	43	41,5	39	35,5	30,5	24	16,5	1"	1"
SIGMA 205 M/T	1,5	1,1	7,4	5,2	3	20	57	56	54	51	46,5	40	32	22	1"	1"

Tipo Type	Potencia		"A"			Con. μF	Caudal m^3/h / Flow m^3/h								Diámetro		
			II 230	III 230	III 400		1,5	3	4,5	6	7	8	9	10	11	ASP.	IMP.
	HP	KW	Altura m.c.a. / Height w.c.m.														
SIGMA 303 M/T	1,2	0,9	7,4	6,3	3,8	40	39	37	35	32	29	25	20	14	8	1 1/2"	1 1/4"
SIGMA 304 M/T	1,5	1,1	8,7	7,1	4,1	40	51	49	46	41	37	32	26	19	11	1 1/2"	1 1/4"
SIGMA 305 M/T	2	1,5	10,3	7,9	4,5	40	65	62	58	52	47	40	32	23	14	1 1/2"	1 1/4"
SIGMA 306 T	3	2,2	-	8,2	4,8	-	77	75	70	63	56	48	39	28	16	1 1/2"	1 1/4"
SIGMA 307 T	3	2,2	-	9,4	5,4	-	90	86	79	70	63	54	44	32	18	1 1/2"	1 1/4"

Tipo Type	Potencia		"A"			Con. μF	Caudal m^3/h / Flow m^3/h								Diámetro		
			II 230	III 230	III 400		1,5	3	4,5	6	9	12	15	18	21	ASP.	IMP.
	HP	KW	Altura m.c.a. / Height w.c.m.														
SIGMA 403 M/T	2	1,5	9,3	7,9	4,5	40	35	34,5	34	33	31	27	23	18	13	1 1/2"	1 1/4"
SIGMA 404 T	3	2,2	-	8,2	4,8	-	44	43	42	41	37	32,5	27	21	14	1 1/2"	1 1/4"

Tipo / Type	A	B	C	D
SIGMA 102	185	385	183	110
SIGMA 103	185	385		
SIGMA 104	210	410		
SIGMA 105	235	435	183	127
SIGMA 202	198	423		
SIGMA 203	198	423		
SIGMA 204	224	449		
SIGMA 205	250	475		
SIGMA 303	195	465	193	147
SIGMA 304	220	490		
SIGMA 305	245	515		
SIGMA 306	270	540		
SIGMA 307	295	565	193	147
SIGMA 403	217	492		
SIGMA 404	256	531		

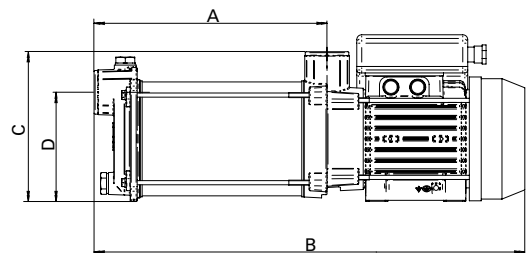

JET



ASPIRACIÓN MÁXIMA 9 METROS.

Aplicaciones:

Bomba autoaspirante con óptima capacidad de aspiración incluso en presencia de gas en el agua. Particularmente indicada para el empleo en grupos de presión domésticos con aspiración negativa, pequeños riegos y jardines, etc. Para aspiraciones superiores a 4 mts. instalar tuberías de aspiración de mayor diámetro al indicado.

Características constructivas:

Cuerpo bomba y soporte motor en fundición con tratamiento anticorrosivo incluso en la superficie interna. Turbinas, difusor y tubo Venturi en tecnopolímero-A, eje en acero inoxidable y cierre mecánico en cerámica carbón.

Motor:

IE3 motor asíncrono, cerrado de ventilación externa, apto para trabajo continuo. Grado de protección IP-55, aislamiento clase F (calentamiento "B"). Protección termo-amperimétrica incorporada y condensador fijo en las versiones monofásicas. Protección IP-44 aislamiento tipo F.



MAXIMUM SUCTION HEIGHT 9 METERS.

Applications:

A self-priming pump with optimal suction capacity even when there is gas in the water. Especially recommended for use in domestic pressure units with negative suction, small irrigation installations and gardens, etc. For suctions of over 4 metres, install suction piping of a larger diameter than that indicated.

Constructive characteristics:

Pump body and motor support in cast iron with rust-proofing even on the interior surface. Impellers, diffuser and Venturi in techno polymer-A, shaft in stainless steel and mechanical seal in carbon ceramic.

Motor:

IE3 asynchronous with external ventilation. Built-in thermo-amperimetric protection and fixed capacitor in the single phase versions. IP-44 protection, type F insulation.

Tipo Type	Con. µF	Potencia		"A"			Caudal m ³ /h / Flow m ³ /h										Diámetro	
		HP	KW	II 230	III 230	III 400	0	1,2	1,8	2,4	3	3,6	6	9	10,5	ASP.	IMP.	
							Altura m.c.a. / Height w.c.m.											
JET 82 M	12,5	0,8	0,59	3,8	-	-	47	34	30	26	23,5	21				1"	1"	
JET 82 T	-			-	2,8	1,6												
JET 102 M	16	1	0,75	5,1	-	-	54	41	37	33	29	26				1"	1"	
JET 102 T	-			-	3,3	1,9												
JET 15 M	25	1,5	1,1	7,2	-	-	61	57	52	50	46	43	39			1 1/4"	1"	
JET 15 T	-			-	5,2	3												
JET 20 M	40	2	1,5	9	-	-	41	39	38	37	36	33	29	24	21	1 1/2"	1 1/4"	
JET 25 M	40			-	10	-	-											
JET 25 T	-	2,5	1,85	-	6,9	4	62	59	57	54	51	42				1 1/4"	1"	

AP

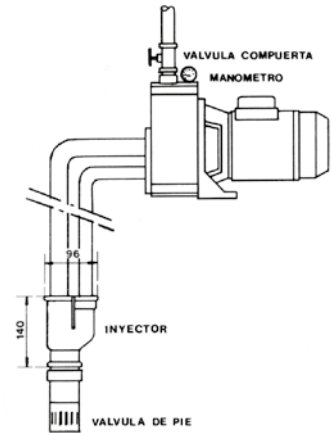

Aplicaciones:

Bomba centrífuga autoaspirante para aspiración profunda hasta 27 metros, por mediación de un inyector. Idónea para pozos de 4" o mayores.

Características constructivas:

Cuerpo y soporte en fundición gris, con tratamiento anticorrosivo incluso en su superficie interna, impellers difusor, and Venturi in tecnopolímero-A, eje en acero inoxidable y cierre mecánico en cerámica-carbón. El modelo AP 10.2 es monoturbina y los modelos AP 15 y AP 25 biturbina. Temperatura del líquido a bombear de 0° C a +40° C. Máxima temperatura ambiente +40° C. Máxima presión de trabajo 8 Kg/cm².

Motor:

IE3 asincrónico, cerrado y de ventilación externa. Protección termo-amperimétrica incorporada y condensador fijo en la versión monofásica. Grado de protección IP-44, según normativa CEI a 2.850 r.p.m., 50 Hz.



Applications:

A self-priming pump for deep suction up to 27 metres by means of an injector. Ideal for 4" wells or larger.

Constructive characteristics:

Pump body and motor support in grey cast iron with rust-proofing even on the interior surface, impellers diffuser, and Venturi in technopolymer-A. Shaft in stainless steel and mechanical seal in carbon ceramic. The AP 10.2 is single impeller and the AP 15 and AP 25 are double impeller.

Temperature of the liquid to be pumped from 0° C to +40° C. Maximum ambient temperature +40° C. Maximum working pressure 8 Kg/cm².

Motor:

IE3 sealed asynchronous with external ventilation. Built-in thermo-amperimetric protection and fixed capacitor in the single phase versions. IP-44 protection according to CEI standard at 2,850 rpm, 50 Hz.

Tipo Type	Cond. µF	Potencia		"A"			Altura de ASP.	Altura m.c.a. / Height w.c.m.					Diámetro	
		HP	KW	II 230	III 230	III 400		20	30	40	50	60	ASP.	IMP.
								Caudal m ³ /h / Flow m ³ /h						
AP 10.2 M	16	1	0,75	3,8	-	-	15	1	0,5	0,1				
AP 10.2 T	-			-	2,6	1,5	18	0,8	0,3				1 1/4"-1"	1"
AP 15 M	31,5	1,5	1,1	7	-	-	21		1,8	1,4	0,9	0,5		
AP 15 T	-			-	4,7	2,7	24		1,7	1,3	0,8	0,4	1 1/4"-1"	1"
				27		1,6	1,1	0,7	0,3					
AP 25 M	40	2,5	1,8	8,3	-	-	21		1,7	1,2	0,7			
AP 25 T	-			-	5,6	3,2	24		1,6	1	0,6		1 1/4"-1"	1"
				27		1,4	0,9	0,5						

PE



Aplicaciones:

Las electrobombas periféricas monobloc serie PE, son particularmente indicadas para servicios en los que sea necesario una presión elevada y un caudal limitado. Son también indicadas para pequeños equipos de presión. El agua debe estar libre de arena.

Características Constructivas:

Cuerpo y soporte bomba-motor en fundición. Turbina en bronce. Eje de acero inoxidable, sello mecánico en carbono de silicio.

TEMPERATURA MAXIMA DEL AGUA: 70° C.

Motor:

Motor eléctrico cerrado de ventilación externa. La versión monofásica incorpora protector térmico y condensador permanente. Grado de protección IP-44. Aislamiento Tipo B.



Applications:

The PE series peripheral single block electropumps are particularly recommended for services requiring a high pressure and limited flow. They are also recommended for small pressure units. The water must be sand-free.

Constructive characteristics:

Pump body and motor support in cast iron. Impeller in bronze. Stainless steel shaft and mechanical seal in silicon carbide.

MAXIMUM WATER TEMPERATURE: 70° C.

Motor:

Sealed electric with external ventilation. The single phase version includes a thermal protector and permanent capacitor. IP-44 protection. Type B insulation.

Tipo Type	Con. µF	Potencia		"A"			Caudal m³/h / Flow m³/h								Diámetro		
		HP	KW	II 230	III 230	III 400	0	0,6	0,7	0,9	1,2	1,5	2	2,4	3	ASP.IMP.	
							Altura m.c.a. / Height w.c.m.										
PE 38-M	8	0,50	0,37	2,9	-	-	42	33	30	27	23	18	11	2,5		1"	1"
PE 60-M	20			5,2	-	-											
PE 60-T	-	1	0,75	-	3,4	2,2	65	56	53	51	48	44	37	31	18	1"	1"

DIVERTECH



Características constructivas:

Bomba fabricada en acero inoxidable AISI-304. Motor eléctrico refrigerado por el agua circulada. Camisa exterior fabricada en acero inoxidable AISI-304L para prevenir posibles corrosiones de la soldadura. **Doble sello mecánico** con cámara de aceite atóxico intermedia. **Condensador externo de clase B**, que garantiza 3 veces más resistencia que un condensador standard. Turbinas y difusores fabricados en tecnopolímero. Conector de cable H07RN-F desmontable. **Interruptor de nivel desmontable** (se incluye el kit para desmontarlo).

Motor:

- Protección IP68.
- Aislamiento clase F.
- Temperatura máxima del líquido: +35°C
- Máximos arranques por hora: 40
- Inmersión máxima: 40 metros
- Todas las versiones monofásicas excepto el modelo DIVERTECH HF 204 M incluyen protección contra sobre consumo.



Constructive features:

Pump made of AISI-304 stainless steel. Electric motor cooled by circulated water. Outer jacket made of AISI-304L stainless steel to prevent possible weld corrosion. **Double mechanical seal** with intermediate



*non-toxic oil chamber. **Class B external capacitor**, which guarantees 3 times more resistance than a standard capacitor. Turbines and diffusers made of technopolymer. Detachable H07RN-F cable connector. **Detachable level switch** (removal kit included).*

Motor:

- IP68 protection.
- Class F insulation.
- Maximum liquid temperature: + 35°C
- Maximum starts per hour: 40
- Maximum immersion: 40 meters
- All single-phase versions except the DIVERTECH HF 204 M model include over-consumption protection.

Tipo Type	Potencia Power		A		Caudal m ³ /h / Flow m ³ /h							
	Kw	HP	230V II	400V III	0	1,2	2,4	3,6	4,8	6	7,2	8,4
Altura m.c.a. / Height w.c.m.												
DIVERTECH 63 M Aut	0,6	0,45	3,7	-	35,5	30	23,5	14,4	5,3			
DIVERTECH 103 M Aut	1	0,75	5,7	-	58,1	50,1	39	24,2	8,2			
DIVERTECH 103 T	1	0,75	-	2,2								
DIVERTECH 153 M Aut	1,5	1,1	7,6	-	68,4	68,4	55,7	34	10,9			
DIVERTECH 153 T	1,5	1,1	-	2,9								
DIVERTECH 154 M Aut	1,5	1,1	8	-	61,5	59,1	54,2	49,3	40,9	32,2	23,3	13,8
DIVERTECH 154 T	1,5	1,1	-	3								
DIVERTECH 204 M Aut	2	1,5	9,4	-	74,4	70,2	65,4	58	49	38,9	28	16,3
DIVERTECH 204 T	2	1,5	-	3,7								

DIVERMATIC



Características constructivas:

Bomba sumergible de 6" fabricada en tecnopolímero, con eje y rejilla en acero inoxidable AISI-304.

La bomba es apta para presurización de viviendas, riego de jardines o llenado automático de depósitos. En su interior incluye un presostato electrónico para la marcha y paro automático de la bomba.

Incluye además un sensor de flujo de agua en su interior que evita el funcionamiento en seco, así como una válvula de retención en la impulsión.

Motor:

- Conexión: 1"
- Profundidad máxima: 12 metros
- Temperatura del agua: de 0°C a 35°C
- Motor IP68. Aislamiento clase F
- Se suministra con 15 metros de cable.



Constructive features:

6" submersible pump made of technopolymer, with shaft and strainer in AISI-304 stainless steel. The pump is suitable for pressurizing homes, watering gardens or automatic filling of tanks. Inside it includes an electronic pressure switch for the automatic start and stop of the pump.

It also includes a water flow sensor inside that prevents dry running, as well as a check valve on drive.

Motor:

- Discharge connection: 1"
- Maximum depth: 12 meters
- Water temperature: from 0°C to 35°C
- IP68 motor. Class F insulation
- Supplied with 15 meters of cable.

Tipo Type	Potencia Power		A 230V II	Caudal m ³ /h / Flow m ³ /h							
	HP	Kw		0	0,9	1,8	2,7	3,6	4,5	5,1	5,4
				Altura m.c.a. / Height w.c.m.							
DIVERMATIC 100 M	1	0,75	4,8	46	41	35,5	29,2	21,8	13,5	7,8	3,5

NOVA FEKA



Aplicaciones:

SERIE NOVA - FEKA: Electrobomba sumergible doméstica que por su forma compacta y manejable es ideal para su uso fijo y portátil. Bomba idónea para achique de filtraciones en bodegas, garajes, sótanos, vaciado de piscinas, etc.

SERIE NOVA SALT: Electrobomba sumergible doméstica con interruptor de nivel incluido, apta para el trabajo con agua salada, lo cual la hace idónea para achique de salmuera, piscinas de agua salada, etc...

NOVABOX: Estación elevadora automática de aguas ligeramente cargadas domésticas procedentes de bañeras, lavabos, duchas y lavaderos situados en semisótanos o bien por debajo del nivel de la red de alcantarillado. Está construido por una electrobomba **Nova 300 M aut.** con 5mts. de cable y enchufe instalado en un contenedor de tecnopolímero con una capacidad de 30 litros y una válvula antirretorno en la impulsión. La estación de elevación se entrega con una bomba ya ensamblada y lista para su funcionamiento totalmente automático.

Características constructivas:

Cuerpo bomba, turbina y filtro de aspiración en tecnopolímero hidrorresistente, tornillería y eje en acero inoxidable, triple cierre mecánico y anillo separador con cámara de aire.

Motor:

Sumergible, asíncrono. El estator está dentro de una cámara hermética de acero inoxidable. Protección termo-amperimétrica y condensador fijo incorporado en versiones monofásicas. Grado de protección IP-68. Aislamiento clase F. Incluye 5 metros de cable.

TEMPERATURA MÁXIMA DEL AGUA: 40° C.

INMERSION MÁXIMA: 7 mts.

Applications:

NOVA - FEKA SERIES: A submersible domestic electropump, whose compact, easy-to-handle form is ideal for its fixed and portable use. The ideal pump for baling filtrations in cellars, garages, basements, emptying pools, etc.

FEKA NOVA SALT: Domestic submersible pump with float switch included, suitable for work with salt water, which makes it ideal for drainage of brine, salt water pools, etc...

NOVABOX: An automatic raising station for lightly loaded household waters from baths, washbasins, showers and washers in semi basements or below the drainage network. It comprises a **Nova 300 M aut.** Electropump, with 5 metres of cable and a switch installed in a 30 litre techno polymer container and a non return valve in the drive. The raising station is delivered with a pump already assembled and ready for fully automated working.

Constructive characteristics:

Pump body, impeller and suction filter in water-resistant techno polymer, bolts and shaft in stainless steel. Triple mechanical seal and separator ring with air chamber.

Motor:

Submersible, asynchronous. The stator is inside a sealed chamber in stainless steel. Thermo-amperimetric protection and fixed capacitor built in to single phase versions. IP-68 protection. Class F insulation.

Includes 5 meters of electric wire.

MAXIMUM WATER TEMPERATURE: 40° C.

MAXIMUM IMMERSION: 7 metres.

Tipo Type	Cond. µF	Potencia		"A"		Caudal m³/h / Flow m³/h											Diámetro	
		HP	KW	II 230	III 400	0	1,2	2,4	3,6	4,5	6	7,5	9	12	15	16	IMP.	Paso Sólido
						Altura m.c.a. / Height w.c.m.												
NOVA 180 M NOVA 180 M Aut	5	0,3	0,22	0,9	-	4,8	4,2	3,5	2,4	1,4							1"	5 mm.
NOVA 200 M NOVA 300 M Aut	8	0,3	0,22	1,5	-	6,8	6,7	6	5,6	5,1	4,6	4	3,4	2,2			1 1/4"	5 mm. 10 mm.
NOVA 600 M NOVA 600 M Aut NOVA 600 T	14 -	0,75	0,55	3,4 -	- 1,6	10,2	9,5	9,1	8,7	8,3	7,8	7,2	6,6	5	3,1	2,2	1 1/4"	10 mm.
FEKA 600 M FEKA 600 M Aut FEKA 600 T	14 -	0,75	0,55	4,3 -	- 1,7	7,5	7	6,6	6,3	6,1	5,7	5,4	4,9	4,1	2,8	2,2	1 1/4"	25 mm.
NOVA SALT M Aut	8	0,3	0,22	1,3	-	6	5,2	4,3	3,4	2,8	1,7	0,6					1 1/4"	5 mm.

MINI DRX



Kit aspiración bajo pedido
Suction kit on demand



MINI DRX M Aut



MINI DRX M Autofix



Aplicaciones:

Bomba sumergible para trabajo con agua limpia, ideal para el empleo en sistemas de agua pluvial y redes de riego, para bombeo de agua desde depósitos, estanques y pozos.

Características Constructivas:

Cuerpo bomba, turbinas y difusores en polipropileno-polietileno, juntas tóricas en NBR, carcasa motor en hierro, eje motor y casquillo cerámico en acero inoxidable AISI-410. **Está equipada de un interruptor de flotador** para el arranque y parada automática de la bomba (modelo Aut) o con flotador fijo (modelo Autofix), **y válvula de retención en la impulsión.**

Motor:

Monofásico 230V/50Hz, con condensador y protección térmica incorporado. Grado de protección IP68 y aislamiento clase F.

Equipa 15 metros de cable eléctrico.

Inmersión máxima: 10 metros.



Applications:

Submersible pump capable to work with clean water, ideal for use in storm water systems and irrigation networks, pumping water from tanks, ponds, wells, and in places where high pressure is required.

Constructive characteristics:

*Pump body, turbines and diffusers in polypropylene-polyethylene, NBR O-rings, motor casing in cast iron, motor shaft and ceramic ferrule in stainless steel AISI-410. **It is equipped with a float switch** for automatic start and stop the pump (Aut type) or fixed float (Autfix type). **Includes check valve on the discharge.***

Motor:

230V/50Hz Single phase with capacitor and thermal protection built.

IP68 protection and Class F isolation.

It comes equipped with 15 meters of electrical cable.

Maximum immersion: 10 meters.

Tipo <i>Type</i>	Potencia		"A" II 230 V	Caudal m ³ /h / Flow m ³ /h								Diámetro <i>Diameter</i>
	HP	KW		0	1,5	3	4,5	6	7,5	9		
				Altura m.c.a. / Height w.c.m.								
MINI DRX M												
MINI DRX M Aut	0,33	0,25	2	9	8,3	7,6	6,8	5,7	4,5	2,7	1-11/4"	
MINI DRX M Autofix												

PUMP



PUMP 400 - 1150



PUMP 700 - 1200 - 2800



Aplicaciones:

Electrobomba sumergida para pequeñas aplicaciones como pueden ser: Acuarios, fuentes, surtidores, refrigeración de máquinas de corte, etc...

Bombas aptas para trabajos con agua salada. Ideales para uso intermitente o bien continuo provistas de regulación de caudal, para adaptarlas a diferentes aplicaciones y usos.

Voltaje 230 V, 50 Hz.

Serie PUMP 400-1150:

Excepcionales prestaciones hidráulicas con bajo consumo eléctrico. Puede trabajar con muy pocos centímetros de nivel de agua.

Serie PUMP 700-1200-2800:

Incluyen cartucho filtrante en la aspiración. Pueden trabajar sin estar sumergidas mediante el uso de los racores proporcionados de serie.

Características constructivas:

Turbina patentada uni-direccional y compacta, amortiguador de gran poder de absorción, construidos con materiales anticorrosivos y resistentes.



Applications:

Submersible electropumps for small applications, such as: aquariums, fountains, jets, cooling cutting machines, etc.

Pumps suitable for work with salt water. Ideal for intermittent or continuous use. Adjustable water flow.

Voltage 230 V, 50 Hz.

PUMP 400-1150 Series:

Exceptional hydraulic performance with low energy consumption.

PUMP 700-1200-2800 Series:

Includes filter sponge. Equipped with tube connectors for non submerged use.

Construction:

Single direction, compact patented impeller, highly absorbent damper, built using rustproof materials.

Tipo Type	ALTURA MÁXIMA MAX. HEIGHT	CAUDAL MÁXIMO MAX. FLOW	CONSUMO WATT CONSUMPTION W.
PUMP 400	70 cm	400 l/h	4
PUMP 1150	70 cm	1.150 l/h.	7

Tipo Type	ALTURA MÁX. MAX. HEIGHT	CAUDAL MÁX. MAX. FLOW	CONSUMO W. CONSUMPTION W.	Ø SALIDA Ø Hose	Largo Length	Ancho Width	Alto Height
PUMP 700	135 cm	700 l/h.	14	12 mm	9,6 cm	5 cm	8,3 cm
PUMP 1200	195 cm	1.200 l/h.	27	12 mm	12,7 cm	6,5 cm	10,8 cm
PUMP 2800	230 cm	2.800 l/h.	55	16 mm	16,5 cm	8,9 cm	12,7 cm

PISCINAS, FILTROS WELLNESS

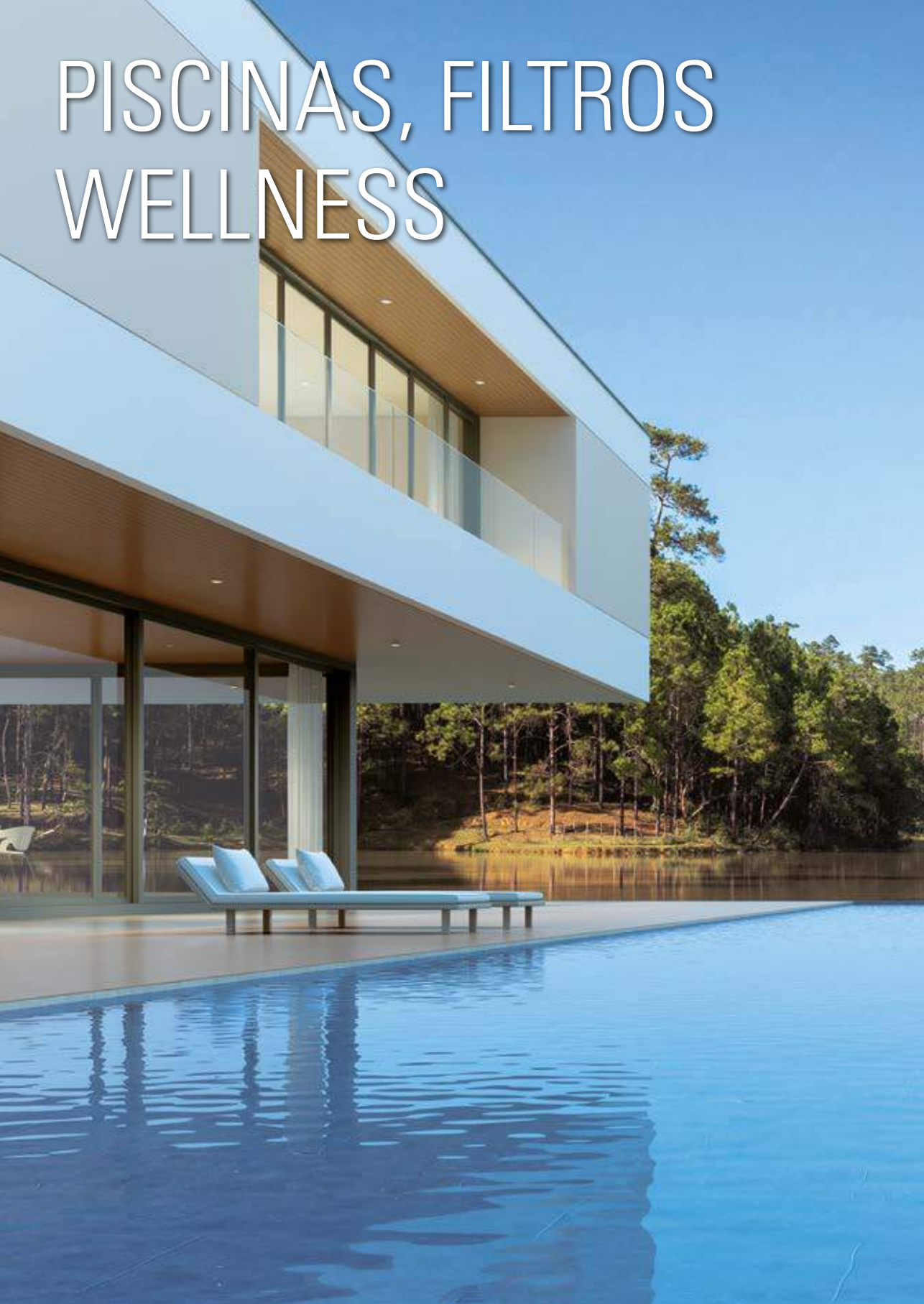

PISCINA PRIVADA

26 OPTIMA
SMART OPTIMA

28 WINNER
SMART WINNER

30 VSD WINNER

32 [e] WINNER

PISCINA COMUNITARIA Y PÚBLICA

34 SUPRA
VSD SUPRA

36 MAGNUS
VERT MAGNUS

38 VSD MAGNUS

40 [e] MAGNUS

42 CF-2
VERT CF-2

43 HF-2
VERT HF-2

44 CF-4
VERT CF-4

45 HF-4
VERT HF-4

46 PREFILTER F
PREFILTER V

47 PREFILTER INOX IH
PREFILTER INOX IV

48 BR-2

49 POOLMATIC

50 BRAVUS

51 KONTRA

52 SOPLANTES

53 PL
DOSING KIT

FILTROS

54 FILTRO DOMÉSTICO

55 FILTRO PISCINA PÚBLICA

WELLNESS

56 ALDARA MINI

57 ALDARA

58 RIMINI

59 RIVA

60 DOLCE

61 HEAT-SS

62 HEAT-TI

OPTIMA



Compatible con variador [e]JOY + soporte pared
Compatible with [e]JOY inverter + wall support



Aplicaciones:

Bomba autoaspirante para piscinas con prefiltro incorporado que junto a las excelentes prestaciones hidráulicas que ofrece, genera una altísima capacidad de filtración. Filtro con tapa transparente que permite observar fácilmente el interior del prefiltro. Cesto prefiltro de grandes dimensiones. Imposibilidad de comunicación eléctrica con el agua, ya que ninguna parte del motor está en contacto con el líquido bombeado.

Especialmente adecuada para trabajo con agua salada.

El variador de velocidad [e]JOY con soporte de pared es compatible solamente con los modelos trifásicos de esta bomba, creando un conjunto bomba + variador que se alimentará en monofásico.

Dos posibilidades de conexión:

- Conexión rosca hembra de 1 1/2"
- Conexión para tubo de PVC de Ø 50 para encolar.
(Se suministran los enlaces rápidos)

Características constructivas:

Cuerpo bomba y difusor en polipropileno resistente a los productos químicos de las piscinas y reforzado con fibra de vidrio garantizando una excelente duración. Turbina en Noryl. Tapa transparente en policarbonato con sistema de cierre mediante pomos. **Sello mecánico en AISI-316, eje en acero inoxidable AISI-316, tornillería en AISI-316 (permite trabajo con agua salada).**

Motor:

IE3 motor asíncrono, cerrado de ventilación externa. Grado de protección IP-55, a 2.850 r.p.m. y 50 Hz (60 Hz bajo demanda). Aislamiento clase F. Rodamientos del motor lubricados de por vida y seleccionados para garantizar larga duración y silenciosidad.

TEMPERATURA MAXIMA DEL AGUA: 40° C.

también con SMART POOL
also with SMART POOL



SMART POOL
página / page 156



Applications:

Self priming pump for swimming pools with a large pre-filter, which together with its excellent hydraulic performance, generates a very large filtering capacity. A filter with a transparent polycarbonate lid that easily allows inspection of the interior of the pre-filter basket. Large dimensions pre-filter basket. No possible electrical communication with the water as no part of the motor is in contact with the water.

Specially suitable for work with salt water.

The [e]JOY variable speed drive with wall mount support is compatible only with the three-phase models of this pump, creating a pump + drive unit that will be powered in single phase.

Two possibilities for the connection of the pipes:

- Female threat \varnothing 11/2"

- PVC glue connections \varnothing 50

(Fast PVC connectors are supplied with the pump)

Constructive characteristics:

Pump body and diffuser in polypropylene, resistant to the chemical products in pools and reinforced with fiber glass, guaranteeing excellent duration. Noryl impeller. Support in aluminum. Mechanical seal in AISI-316. **Shaft in Stainless steel in AISI-316 (ready to work with salt water).**

Motor:

IE3 electrical asynchronous motor, close with external ventilation. Protection IP-55. 2,850 r.p.m. 50 Hz. (60Hz. Under demand). Class F insulation. Motor bearings greased for life and selected to ensure long duration and silent work.

MAXIMUM WATER TEMPERATURE: 40° C.

Tipo Type	HP	KW	Cond. μ F	"A"			Altura m.c.a. / Height w.c.m.								\varnothing ASP.	\varnothing IMP.
				II 230	III 230	III 400	4	6	8	10	12	14	16	18		
Caudal m ³ /h / Flow m ³ /h																
OPTIMA 25 M	0,25	0,16	18	2,6	-	-	10	8	6	4	0,5	-	-	-	11/2" o o \varnothing 50PVC	11/2" o o \varnothing 50PVC
OPTIMA 33 M	0,33	0,25	18	2,9	-	-	12	10	8	5,5	2	-	-			
OPTIMA 50 M	0,5	0,37	18	3,3	-	-	14	12	10	7	5	-	-			
OPTIMA 75 M/T	0,75	0,55	20/-	3,8	2,8	1,7	16	15	12,5	10	8	4,2	-			
OPTIMA 100 M/T	1	0,75	20/-	4,2	3,5	2	17	16	15,3	13	10,5	7,6	5,5			
OPTIMA 150 M/T	1,5	1,1	30/-	7,3	5,0	2,9	18	17,3	15,9	14,5	12,8	11	9	5		

PARA MÁS INFORMACIÓN CONSULTAR NUESTRO CATÁLOGO TÉCNICO DE BOMBAS PARA PISCINAS
CHECK OUR TECHNICAL CATALOGUE OF SWIMMING POOL PUMPS FOR MORE INFORMATION

WINNER



Aplicaciones:

Electrobomba autoaspirante para piscinas, con prefiltro incorporado de grandes dimensiones, lo que genera una altísima capacidad de filtración.

Filtro con tapa transparente en policarbonato que permite observar fácilmente el interior del cesto prefiltro. Imposibilidad de comunicación eléctrica con el agua, ya que ninguna parte del motor tiene contacto con el fluido.

Dos posibilidades de conexión:

- **Conexión rosca hembra de 2"**
- **Conexión para tubo de PVC de Ø 63 para encolar.** (Se suministran los enlaces rápidos)

Características constructivas:

Cuerpo bomba, tapa cuerpo bomba, base y difusor en polipropileno, resistente a los productos químicos de las piscinas y reforzado con fibra de vidrio garantizando una excelente duración. Turbina en Noryl. **Eje en acero inoxidable AISI 316. Sello mecánico en AISI-316 (permite trabajo con agua salada).** Conexión de aspiración e impulsión a 2". **Incorpora de serie llave para apertura de la tapa prefiltro sin esfuerzo.**

Motor:

IE3 motor asíncrono, cerrado de ventilación externa. Grado de protección IP-55. 2.850 r.p.m. 50 Hz (60 Hz bajo demanda). Aislamiento clase F.
TEMPERATURA MAXIMA DEL AGUA: 40° C.

también con SMART POOL
also with SMART POOL



SMART POOL
página / page 156



Applications:

A self-priming pump for pools with a large prefilter to generate a very high filtration capacity. A filter with a transparent Polycarbonate lid to be able to easily see the interior of the prefilter basket. No possible electric contact with the water as no part of the motor is in contact with it.

Two possibilities for the connection of the pipes:

- Female thread Ø 2"
- PVC glue connections Ø 63
(Fast PVC connectors are supplied with the pump)

Constructive characteristics:

Pump body, pump body lid, base and diffuser in polypropylene, resistant to the chemical products present in pools and reinforced with glass fibre to ensure excellent duration. Impeller in Noryl. **Shaft in stainless steel AISI-316. Mechanical seal in AISI-316 (ready to work with salt water).** Connection to 2" suction and drive". **Includes an easy open key.**

Motor:

IE3 sealed asynchronous with external ventilation. IP-55 protection, 2,850 rpm, 50 Hz. Class F insulation.
MAXIMUM WATER TEMPERATURE: 40° C.

Tipo Type	HP	KW	Cond. µF	"A"			Altura manométrica m.c.a. - Manometric height w.c.m.										Ø ASP.	Ø IMP.
				II 230	III 230	III 400	4	6	8	10	12	14	16	18	21			
Caudal m ³ /h / Flow m ³ /h																		
WINNER 50 M WINNER 50 T	0,5	0,37	20	4,4	-	-	17,5	15,6	13,5	11,1	8,4						2" o Ø 63PVC	2" o Ø 63PVC
WINNER 75 M WINNER 75 T			20	4,75	-	-	19,5	18	15,7	13,5	10,8	7,9						
WINNER 100 M WINNER 100 T	1	0,75	25	5,5	-	-	23,2	21,1	19,7	18	15	12,3	8,7					
WINNER 150 M WINNER 150 T			30	7,3	-	-	27	25	23	21	19	17	14	10				
WINNER 200 M WINNER 200 T	2	1,5	40	9,2	-	-		28	26	24	21	18	14	12				
WINNER 300 M WINNER 300 T			40	12,2	-	-		32	30	29	27	23	20	15	12			
			-	-	8,6	5,0												

PARA MÁS INFORMACIÓN CONSULTAR NUESTRO CATÁLOGO TÉCNICO DE BOMBAS PARA PISCINAS
CHECK OUR TECHNICAL CATALOGUE OF SWIMMING POOL PUMPS FOR MORE INFORMATION

VSD WINNER



Aplicaciones:

La serie de bombas VSD WINNER incorporan a la bomba WINNER trifásica standard el variador [e]JOY, creando un conjunto de alimentación monofásica. El conjunto bomba + variador de velocidad funciona por modulación de frecuencia, obteniendo un gran confort y minimizando los costes energéticos. El software está especialmente desarrollado para la automatización de la bomba. Gracias a un sencillo asistente, se proporciona la información necesaria a la bomba para tener una instalación completamente operativa. El Sistema permite la programación de varios ciclos de filtración diarios con diferente velocidad de funcionamiento para cada ciclo.

Características principales:

- Ahorro energético muy significativo debido a que la bomba puede modificar su velocidad de trabajo a los requerimientos de la instalación.
- 3 velocidades de funcionamiento diferentes editables por el usuario.
- Diferentes velocidades de trabajo para diferentes programaciones.
- Conjunto bomba-variador extremadamente silencioso.
- Protección de sobrecarga del motor por consumo.
- Control de clorador salino.
- Permite controlar los ciclos de iluminación de la piscina.
- Incorpora un menú de funcionamiento específico para la limpieza del filtro.

Applications:

The VSD WINNER pumps incorporate the [e]JOY variable speed drive to the standard WINNER pump, creating a single-phase set. The pump + speed drive set works by frequency modulation, obtaining great comfort and minimizing energy costs. The software is specially developed for the automation of the pump. Thanks to a simple wizard, the necessary information is provided to the pump to have a fully operational installation. The System allows the programming of several daily filtration cycles with different operating speeds for each cycle.

Main features:

- Very significant energy savings due to the fact that the pump can modify its working speed to the installation requirements.
- 3 different operating speeds editable by the user.
- Extremely silent pump-inverter set.
- Consumption motor overload protection.
- Different working speeds for different programming.
- Salt chlorinator control.
- It allows to control the lighting cycles of the pool.
- It incorporates a specific operating menu for filter cleaning.

VSD WINNER funcionando a 2900 RPM / VSD WINNER working at 2900 RPM

Tipo Type	HP	KW	"A" II 230	Altura manométrica m.c.a. - Manometric height w.c.m.									
				4	6	8	10	12	14	16	18	21	
				Caudal m ³ /h / Flow m ³ /h									
VSD WINNER 50 M	0,5	0,37	4,4	17,5	15,6	13,5	11,1	8,4					
VSD WINNER 75 M	0,75	0,55	4,75	19,5	18	15,7	13,5	10,8	7,9				
VSD WINNER 100 M	1	0,75	5,5	23,2	21,1	19,7	18	15	12,3	8,7			
VSD WINNER 150 M	1,5	1,1	7,3	27	25	23	21	19	17	14	10		
VSD WINNER 200 M	2	1,5	9,2		28	26	24	21	18	14	12		
VSD WINNER 300 M	3	2,2	12,2		32	30	29	27	23	20	15	12	

VSD WINNER funcionando a 2300 RPM / VSD WINNER working at 2300 RPM

Tipo Type	HP	W	"A" II 230	Altura manométrica m.c.a. - Manometric height w.c.m.									
				4	5	6	7	8	9	10	11	12	
				Caudal m ³ /h / Flow m ³ /h									
VSD WINNER 50 M	0,25	185	2,2	12,7	11,4	10,2	8,5	5,6					
VSD WINNER 75 M	0,37	275	2,35	14	12,6	11,1	9,4	7,6					
VSD WINNER 100 M	0,5	375	2,7	16,9	15,7	14,2	12,5	10,5	9	7			
VSD WINNER 150 M	0,75	550	3,6	19,6	18,5	17	15,5	14	12,5	10,6	8,5		
VSD WINNER 200 M	1	750	4,5	21,8	21	19,4	17,7	15,8	14	11,8	9,5		
VSD WINNER 300 M	1,5	1100	6,0	25,5	24,1	23,5	22,1	20,6	18,5	16,7	14,5	12	

VSD WINNER funcionando a 1700 RPM / VSD WINNER working at 1700 RPM

Tipo Type	HP	W	"A" II 230	Altura manométrica m.c.a. - Manometric height w.c.m.									
				2	2,5	3	3,5	4	4,5	5	5,5	6	
				Caudal m ³ /h / Flow m ³ /h									
VSD WINNER 50 M	0,1	75	0,89	9,6	8,9	8	7	5,7	3,2				
VSD WINNER 75 M	0,15	110	0,95	10,6	9,7	8,8	7,6	6,6	5				
VSD WINNER 100 M	0,2	152	1,1	12,8	12	11	10	8,9	7,8	6,5	5,2		
VSD WINNER 150 M	0,3	222	1,5	14,8	14	13	12,4	11,2	10	8,8	7,6	6,4	
VSD WINNER 200 M	0,4	302	1,8	16,4	15,8	15	13,8	12,5	11,5	10	9	7,2	
VSD WINNER 300 M	0,6	443	2,4		18,5	17,6	16,8	16	15	13,7	12,5	11	

VSD WINNER funcionando a 1100 RPM / VSD WINNER working at 1100 RPM

Tipo Type	HP	W	"A" II 230	Altura manométrica m.c.a. - Manometric height w.c.m.									
				0,6	0,9	1,2	1,5	1,8	2,1	2,4	2,7	3	
				Caudal m ³ /h / Flow m ³ /h									
VSD WINNER 50 M	0,03	21	0,24	6,6	6,1	5,3	4,4	2,9					
VSD WINNER 75 M	0,04	30	0,26	7,4	6,7	5,8	4,9	3,8					
VSD WINNER 100 M	0,05	42	0,3	8,7	8,2	7,3	6,4	5,3	4,2				
VSD WINNER 150 M	0,08	60	0,4	10,2	9,4	8,6	7,7	6,8	5,7	4,6			
VSD WINNER 200 M	0,11	87	0,5		10,7	9,7	8,7	7,7	6,2	5,3			
VSD WINNER 300 M	0,16	120	0,65		12,3	11,5	10,8	10	8,7	7,7	6	4,5	

LOS DATOS INDICADOS TIENEN UN FIN ORIENTATIVO Y PUEDEN TENER DIFERENCIAS EN UNA INSTALACION REAL
 THE INDICATED DATA HAVE A GUIDANCE PURPOSE AND MAY HAVE DIFFERENCES IN A REAL INSTALLATION

[e]WINNER

con motor de imanes permanentes
with permanent magnet motor



Soporte de pared opcional
Wall support as an option



[e] Winner 300:

Bomba de piscina que incorpora **variador de frecuencia con un software específico para esta bomba, y un motor síncrono de imanes permanentes de altísima eficiencia**. La combinación de estas dos tecnologías innovadoras íntegramente diseñadas y desarrolladas por **SACI PUMPS**, nos aseguran un ahorro de más del 80% en consumo de energía comparado con las bombas tradicionales.

Al incorporar un software desarrollado especialmente para la automatización de la bomba [e] winner, se ha dispuesto un sencillo menú previo. Para que su bomba bomba y su instalación sea totalmente operativa.

Solamente se deber indicar:

- Fecha y hora actual
- Volumen de la piscina
- Filtro que dispone.

Características [e] pool drive:

- Incorporan software desarrollado especialmente para la automatización de la bomba [e] winner de forma intuitiva y de extrema facilidad de programación, no requiere de ningún conocimiento técnico previo por parte del usuario.
- **Ahorro energético muy importante** que puede llegar a más del 80%, del costo energético.
- Extremadamente Silenciosa, (≈ 40 dB).



[e] Winner 300:

*Swimming pool pumps compound by a **variable frequency drive with a special software for this pump and a high efficiency synchronous motors with permanent magnets**. The combination of these two innovative technologies designed and developed entirely by **SACI PUMPS**, assure us energy savings of over 80% compared to the traditional pumps.*

The software is specially developed for the automation of [e] winner pump, an easy setup wizard is provided to leave the pump and the installation fully operational.

Just 3 indicators to be filled:

- Current date
- Pool Volume
- Filter size.

Features [e] pool drive:

- *Incorporates a specially developed software for automation of the [e] winner pump with an easy and intuitive programming. Any technical knowledge is required from the user to program it.*



- Adaptabilidad total, rango de velocidades de 400 rpm a 3.000 rpm. **La bomba se adapta automáticamente a la situación de máximo ahorro.**
- Gran versatilidad, Un solo modelo adaptable a cualquier tipo y volumen de piscina desde 15m³ hasta 450 m³, No es necesario tener diferentes bombas, nuestra [e] winner es capaz de controlar la filtración, juegos de agua, lavado y aspirado en cualquier situación.
- Nuevo motor Brushless IPM sensorless de imanes permanentes, que reduce la temperatura del motor de manera extrema, lo cual alarga la vida de rodamientos y partes mecánicas.
- Alta Protección, Los límites introducidos durante la programación protegen su bomba, su instalación, su filtro y a los usuarios.
- Conectividad integrada con otros elementos de la piscina como un clorador salino, bomba de calor...
- Gran display LCD donde toda la información necesaria se refleja con claridad.
- Pueden suministrarse bomba y variador por separado
- **Very significant energy savings** that can reach more than 80% of the energy cost.
- **Extremely silent** (≈ 40 dB).
- **Total adaptability**, speed range from 400 rpm to 3,000 rpm. **The pump automatically sets to the point of maximum savings.**
- **Great versatility**, one single model to any size of pool from 15 m³ to 450 m³. Not necessary to have different pumps, our [e] winner is able to control filtration, fountains, backwashing and vacuuming in any situation.
- **New IPM sensor less brushless motor** with permanent magnets, which reduces the engine temperature and extends the life of bearings and mechanical parts.
- **High Protection**, the parameters set during programming protect your pump, installation, filter and users.
- **Integrated connectivity** to manage salt chlorinator, heat pump, lights, etc.
- **Large LCD display** where all necessary information is clearly reflected.
- **Pump and inverter can be supplied separately**

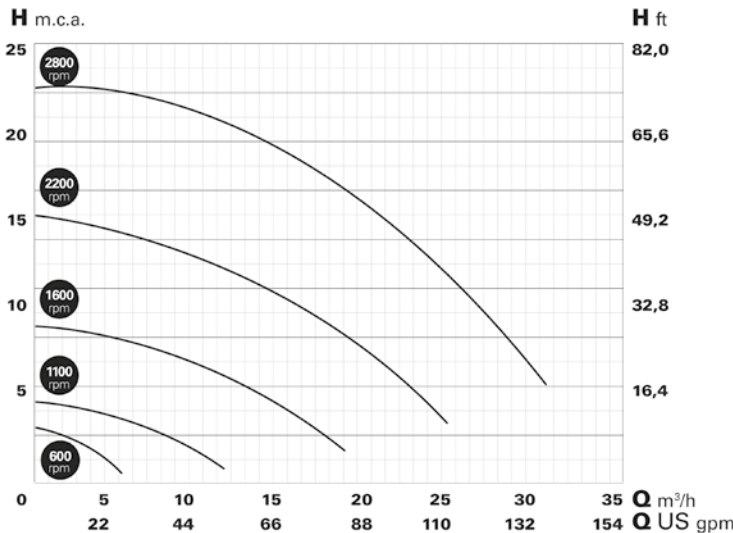

Ejemplo de ahorro energético para una piscina de 50 m³
Energy saving example for a pool of 50 m³

Tipo / Type	HP	RPM	TIPO DE MOTOR MOTOR TYPE	PISCINA POOL m ³	TRABAJO WORK m ³ /h	h/día h/day	KW	KW/h	AHORRO SAVING	KW/h/Año KW/h/Year	Kg/CO ₂ /Año Kg/CO ₂ /Year	Árboles salvados Trees saved
WINNER 75 M	0,75	2.900	ASINCRONO	50	13,5	4	0,55	2,2	-	803	302	-
[e] WINNER 300	3	600	BRUSHLESS IPM	50	6	8,33	0,04	0,33	85%	122	56	241

SUPRA

bomba autoaspirante para piscina
self priming pump for swimming pools



también disponible VSD SUPRA
also available VSD SUPRA



2.900 r.p.m.



Supra:

- Polipropileno + Fibra de Vidrio
- Eje en acero inoxidable AISI-316
- Rodete en Noryl
- Sello mecánico en acero inoxidable AISI-316
- Tapa prefiltro en policarbonato

Características:

- Doble conexión, rosca y racores
- Rosca hembra 3", racor encolar DN90
- **Pintura por cataforesis**
- Cesto prefiltro de gran tamaño
- Tornillería en acero inoxidable AISI-316
- Motor asíncrono IE3 a 2900 rpm (3450 rpm @ 60 Hz)
- Rodamientos lubricados de por vida
- Grado IP-55, Aislamiento clase F
- Máxima temperatura del agua: +40°C



Supra:

- *Polypropylene + Fiberglass*
- *AISI-316 stainless steel shaft*
- *Impeller in Noryl*
- *Mechanical seal in stainless steel AISI-316*
- *Polycarbonate prefilter cap*

Features:

- *Double connection, thread and fittings*
- *3" female thread, fittings glue DN90*
- ***Cataphoresis painting***
- *Large pre-filter basket*
- *Stainless steel screws AISI-316*
- *IE3 asynchronous motor at 2900 rpm (3450 rpm @ 60 Hz)*
- *Lubricated bearings for life*
- *IP-55 Grade, Class F Insulation*
- *Maximum water temperature: + 40°C*

Datos Técnicos / Technical data

H m.c.a.

H ft.

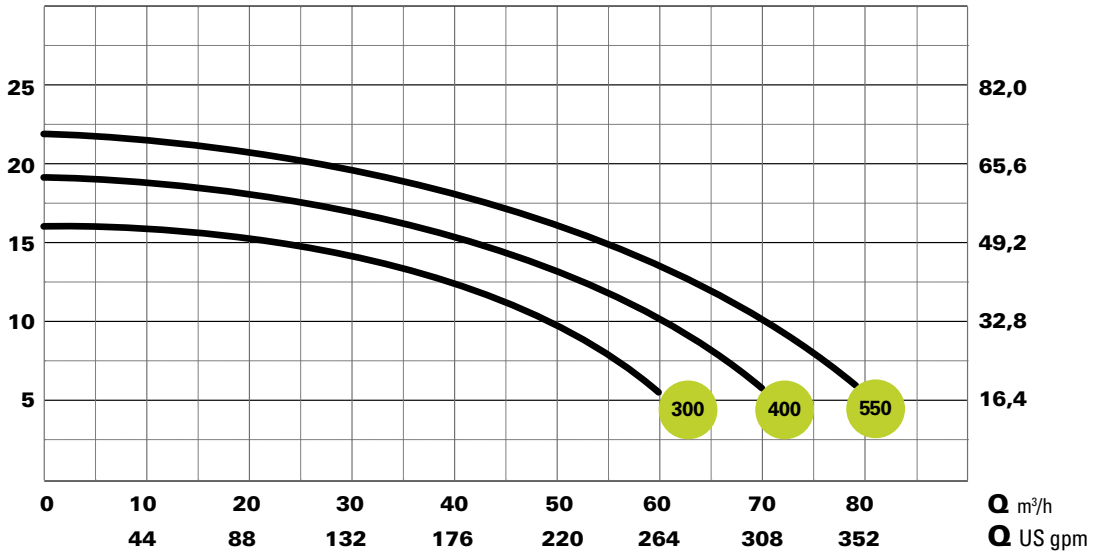

Tipo / Type	HP	kW	A			RPM	Altura m.c.a / Height w.c.m							ASP / IMP
			II	III	III		6	8	10	12	14	16	18	
			230	230	400		Caudal m³/h / Flow m³/h							
SUPRA 300 M/T	3	2,2	16	9,4	5,3	2900	59	54	47	39	28	16	-	3" PVC90
SUPRA 400 T	4	3	-	12,5	6,9	2900	68	63	58	52	45	36	23	
SUPRA 550 T	5,5	4	-	-	8,8	2900	78	74	70	65	59	50	39	

NOMBRE	DIMENSIÓN (mm)
A	277
B	336
C	704
D	397
E	140
F	340
G	210
H	260
I	420
J	310
DNA	PVC 90
DNI	PVC 90

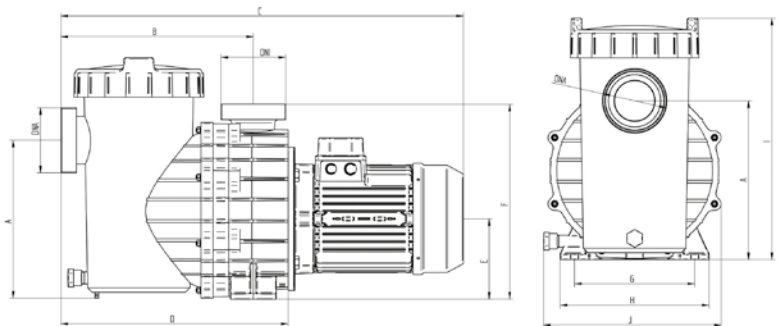

MAGNUS



1.450 r.p.m. de 2,5 a 10 HP
2.850 r.p.m. 12,5 y 15 HP



Aplicaciones:

Bomba extremadamente silenciosa dado que gira a 1.450 rpm hasta 10CV. Bomba autoaspirante de gran caudal con motores de 1.450rpm y 2.850 rpm ideal para grandes equipos de filtración. Incorpora un prefiltro en la aspiración de grandes dimensiones, que junto a las excelentes prestaciones hidráulicas que ofrece, genera una altísima capacidad de filtración. Filtro con tapa transparente en policarbonato que permite observar fácilmente el interior del cesto prefiltro. Imposibilidad de comunicación eléctrica con el agua, ya que ninguna parte del motor tiene contacto con el líquido bombeado.

Características constructivas:

Cuerpo Prefiltro, Cuerpo bomba, Voluta, Base y Tapa cuerpo bomba en polipropileno resistente a los productos químicos de las piscinas, y reforzado con fibra de vidrio. Cesto prefiltro en polietileno (AISI-316 bajo

demanda). Rodete en Noryl ó Bronce. Tapa prefiltro en policarbonato con sistema de cierre con cuatro pomos. **Rodete de Noryl en MAGNUS-4 250, 300 y 400. Rodete de Noryl o Bronce en MAGNUS-2 1250 y 1500. Sello mecánico en acero inoxidable AISI-316 (permite trabajo con agua salada).** Tornillería en acero inoxidable AISI 304. **Eje en acero inoxidable AISI-316. Kit contra bridas y tornillos disponible bajo demanda.**

Motor:

IE3 motor asíncrono cerrado de ventilación externa. Grado de protección IP-55. Aislamiento clase F. 1.450 rpm y 2.850 rpm. Disponibles versiones a 60 Hz. Rodamientos engrasados de por vida, garantizando una larga duración y un trabajo silencioso.

también disponible versión vertical
also available vertical version



Applications:

Extremely silent pump, at 1,450 rpm until 10HP. High flow self priming pump with motors at 1.450 rpm & 2.850 rpm, designed for big filtration installations. Equipped with a big capacity strainer in the inlet that among its excellent performance generates a high filtration capacity. Prefilter with a transparent lid that allows easy inspection of the basket. No possible electrical contact with the water as no part of the motor is open to it.

Constructive characteristics:

Prefilter, Pump body, Volut, Base & pump body lid in poly-propylene resistant to Chemicals products used in pool sand reinforced with fiber glass. Prefilter basket in poly-thene (AISI-316 under demand). Strainer lid in poly-

carbonate with a closing system using four handles. **Noryl impeller in MAGNUS-4 250, 300 & 400. Noryl or Bronze impeller in MAGNUS-4 550, 750 & 1000. Bronze impeller in MAGNUS-2 1250 & 1500. Mechanical seal in AISI-316 (ready to work with salt water). Nuts and bolts in stainless steel AISI 304. Shaft in stainless steel in AISI-316. Flanges and bolts kit available under demand.**

Motor:

IE3 standard Asynchronous motor, sealed with external ventilation. Protection IP-55. Isolation class F. 1,450 rpm & 2,850 rpm. 60Hz pump also available. Motor bearings greased for life and selected to ensure long duration and silent working.

Tipo Type	Potencia		"A"			r.p.m.	Altura m.c.a. / Height w.c.m.										ASP. IMP		Mínimo diámetro de aspiración Minimum size of suction pipe	
	HP	KW	III 230	III 400	III 690		6	8	10	12	14	16	18	20	22					
Caudal m ³ /h / Flow m ³ /h																				
MAGNUS-4 250	2,5	1,8	8,5	4,9	-	1.450	53	43	32	18								110 (4")	110 (4")	110
MAGNUS-4 300	3	2,2	9,4	5,3	-	1.450	62	54	43	26	10									125
MAGNUS-4 400	4	3	12,5	6,9	-	1.450	74	66	56	42	29	14								140
MAGNUS-4 550	5,5	4	15,3	8,8	-	1.450	123	104	84	57	30									160
MAGNUS-4 750	7,5	5,5	-	12	7	1.450	143	127	107	85	57	12								180
MAGNUS-4 1000	10	7,5	-	15,8	9,2	1.450	160	145	126	107	80	48	14							180
MAGNUS-2 1250	12,5	9,2	-	18,5	10,7	2.850		167	152	136	118	99	80	47						180
MAGNUS-2 1500	15	11	-	20,9	12	2.850		188	177	162	146	130	112	92	66					200

VSD MAGNUS

efficiency class /inverter

IE3+

Bomba de alta eficiencia con
variador de velocidad

*High efficiency pump with
speed drive*



Aplicaciones:

La serie de bombas VSD MAGNUS incorporan a la bomba MAGNUS el variador de velocidad [e]POOL. El conjunto bomba + variador de velocidad funciona por modulación de frecuencia, obteniendo un gran confort y minimizando los costes energéticos. El software está especialmente desarrollado para la automatización de la bomba. Gracias a un sencillo asistente, se proporciona la información necesaria a la bomba para tener una instalación completamente operativa. El Sistema permite la programación de varios ciclos de filtración diarios con diferente velocidad de funcionamiento para cada ciclo. En instalaciones con varias bombas, las bombas se comunicarán entre ellas para trabajar el mismo número de horas. Además, es capaz de hacer funcionar varias bombas a la vez.

Características principales:

- Ahorro energético muy significativo debido a que la bomba puede modificar su velocidad de trabajo a los requerimientos de la instalación.
- Diferentes velocidades de trabajo para diferentes programaciones.
- Comunicación entre varias bombas.
- Alternancia de trabajo por tiempo.
- Conjunto bomba-variador extremadamente silencioso.
- **Sistema automático de limpieza de filtros de arena.**
- Protección de sobrecarga del motor por consumo.
- Sistema de auto aprendizaje para la búsqueda constante de los parámetros que determinan un funcionamiento en seco.
- Pueden suministrarse bomba y variador por separado.

Motor:

Asíncrono cerrado de ventilación externa. Grado de protección IP-55. Aislamiento clase F. Doble frecuencia 50 Hz y 60 Hz. Rodamientos engrasados de por vida, garantizando una larga duración y un trabajo silencioso.



Applications:

The VSD MAGNUS series of pumps incorporate the [e] POOL variable speed drive to the MAGNUS pump. The pump + speed drive set works by frequency modulation, obtaining great comfort and minimizing energy costs. The software is specially developed for the automation of the pump. Thanks to a simple wizard, the necessary information is provided to the pump to have a fully operational installation. The System allows the programming of several daily filtration cycles with different operating speeds for each cycle. In installations with several pumps, the pumps will communicate with each other to work the same number of hours. In addition, it is capable of operating several pumps at the same time.

Main features:

- Very significant energy savings due to the fact that the pump can modify its working speed to the installation requirements.
- Different working speeds for different programming.
- Communication between several pumps.
- Alternating work by time.
- Extremely silent pump-inverter set.
- **Automatic sand filter cleaning system.**
- Consumption motor overload protection.
- Self-learning system for the constant search of the parameters that determine a dry operation.
- Pump and inverter can be supplied separately

Motor:

Asynchronous closed external ventilation. Degree of protection IP-55. Class F insulation. Double frequency 50 Hz and 60 Hz. Bearings greased for life, guaranteeing a long life and a silent work.

Ejemplo de bomba VSD MAGNUS funcionando a 50Hz / VSD MAGNUS example of pump working at 50Hz

Tipo Type	Potencia		"A" III 400	r.p.m.	Altura m.c.a. / Height w.c.m.								
	HP	KW			6	8	10	12	14	16	18	20	22
					Caudal m ³ /h / Flow m ³ /h								
VSD MAGNUS-4 250	2,5	1,8	4,9	1.450	53	43	32	18	-	-	-	-	-
VSD MAGNUS-4 300	3	2,2	5,3	1.450	62	54	43	26	10	-	-	-	-
VSD MAGNUS-4 400	4	3	6,9	1.450	74	66	56	42	29	14	-	-	-
VSD MAGNUS-4 550	5,5	4	8,8	1.450	123	104	84	57	30	-	-	-	-
VSD MAGNUS-4 750	7,5	5,5	12	1.450	143	127	107	85	57	12	-	-	-
VSD MAGNUS-4 1000	10	7,5	15,8	1.450	160	145	126	107	80	48	14	-	-
VSD MAGNUS-2 1250	12,5	9,2	18,5	2.850	-	167	152	136	118	99	80	47	-
VSD MAGNUS-2 1500	15	11	20,9	2.850	-	188	177	162	146	130	112	92	66

Ejemplo de bomba VSD MAGNUS funcionando a 40Hz / VSD MAGNUS example of pump working at 40Hz

Tipo Type	Potencia		"A" III 400	r.p.m.	Altura m.c.a. / Height w.c.m.								
	HP	KW			4	5	6	7	8	10	12	14	16
					Caudal m ³ /h / Flow m ³ /h								
VSD MAGNUS-4 250	1,06	0,78	2	1.160	42	35	28	21	12	-	-	-	-
VSD MAGNUS-4 300	1,38	1,01	2,4	1.160	50	43	37	30	22	4	-	-	-
VSD MAGNUS-4 400	1,79	1,32	3,1	1.160	57	52	47	41	34	19	-	-	-
VSD MAGNUS-4 550	2,58	1,9	4,1	1.160	88	78	65	52	36	-	-	-	-
VSD MAGNUS-4 750	3,48	2,56	5,6	1.160	108	98	86	74	61	28	-	-	-
VSD MAGNUS-4 1000	5	3,7	7,9	1.160	126	114	105	94	80	46	-	-	-
VSD MAGNUS-2 1250	6,2	4,6	9,2	2.320	139	131	124	116	106	84	56	-	-
VSD MAGNUS-2 1500	7,6	5,6	10,6	2.320	150	145	138	130	126	112	96	55	8

Ejemplo de bomba VSD MAGNUS funcionando a 30Hz / VSD MAGNUS example of pump working at 30Hz

Tipo Type	Potencia		"A" III 400	r.p.m.	Altura m.c.a. / Height w.c.m.							
	HP	KW			2	3	4	5	6	7	8	9
					Caudal m ³ /h / Flow m ³ /h							
VSD MAGNUS-4 250	0,45	0,33	0,8	870	33,5	25	15	2	-	-	-	-
VSD MAGNUS-4 300	0,58	0,43	1	870	39	31	22	11	-	-	-	-
VSD MAGNUS-4 400	0,76	0,56	1,3	870	44	37	30	21	10	-	-	-
VSD MAGNUS-4 550	1,07	0,79	1,7	870	70	55	38	12	-	-	-	-
VSD MAGNUS-4 750	1,47	1,08	2,3	870	84	70	46	36	10	-	-	-
VSD MAGNUS-4 1000	2,1	1,55	3,3	870	98	84	69	50	24	-	-	-
VSD MAGNUS-2 1250	2,6	1,9	3,8	1.740	108	96	87	72	56	34	-	-
VSD MAGNUS-2 1500	3,25	2,39	4,5	1.740	114	105	96	89	75	64	39	3

Ejemplo de bomba VSD MAGNUS funcionando a 20Hz / VSD MAGNUS example of pump working at 20Hz

Tipo Type	Potencia		"A" III 400	r.p.m.	Altura m.c.a. / Height w.c.m.							
	HP	KW			1	1,4	1,8	2,2	2,6	3	3,4	3,8
					Caudal m ³ /h / Flow m ³ /h							
VSD MAGNUS-4 250	0,13	0,09	0,25	580	21	15,5	9,5	2	-	-	-	-
VSD MAGNUS-4 300	0,17	0,12	0,3	580	25	20	14,5	8	-	-	-	-
VSD MAGNUS-4 400	0,22	0,16	0,38	580	28,5	24,5	20	14,5	8	-	-	-
VSD MAGNUS-4 550	0,32	0,23	0,5	580	44	35	24	9	-	-	-	-
VSD MAGNUS-4 750	0,44	0,32	0,7	580	54	46	36	85	10	-	-	-
VSD MAGNUS-4 1000	0,62	0,45	0,9	580	63	55	46	34	19	-	-	-
VSD MAGNUS-2 1250	0,77	0,57	1	1.160	68	64	57	48	39	27	5	-
VSD MAGNUS-2 1500	0,95	0,70	1,3	1.160	75	71	66	60	53	44	32	2

LOS DATOS INDICADOS TIENEN UN FIN ORIENTATIVO Y PUEDEN TENER DIFERENCIAS EN UNA INSTALACION REAL
THE INDICATED DATA HAVE A GUIDANCE PURPOSE AND MAY HAVE DIFFERENCES IN A REAL INSTALLATION

[e]MAGNUS

efficiency class

IE5

Variador de frecuencia y motor de imanes permanentes

Frequency drive and permanent magnet motor



Aplicaciones:

La bomba [e]MAGNUS es la nueva generación de bombas para filtración de piscina pública que incorporan un variador de velocidad a una bomba MAGNUS con motor síncrono de imanes permanentes de altísima eficiencia energética. El software está especialmente desarrollado para la automatización de la bomba. Gracias a un sencillo asistente, se proporciona la información necesaria a la bomba para tener una instalación completamente operativa. El Sistema permite la programación de varios ciclos de filtración diarios con diferente velocidad de funcionamiento para cada ciclo. En instalaciones con varias bombas, las bombas se comunicarán entre ellas para trabajar el mismo número de horas. Además, es capaz de hacer funcionar varias bombas a la vez.

Características principales:

- Ahorro energético muy significativo debido a que la bomba puede modificar su velocidad de trabajo a los requerimientos de la instalación.
- Diferentes velocidades de trabajo para diferentes programaciones.
- Comunicación entre varias bombas.
- Alternancia de trabajo por tiempo.
- Conjunto bomba-variador extremadamente silencioso.
- **Sistema automático de limpieza de filtros de arena.**
- Protección de sobrecarga del motor por consumo.
- Sistema de auto aprendizaje para la búsqueda constante de los parámetros que determinan un funcionamiento en seco.
- **Nuevo motor brushless IPM sensorless de imanes permanentes, que reduce la temperatura del motor de manera extrema, lo cual alarga la vida útil de rodamientos y partes mecánicas.**

Motor:

Síncrono de imanes permanentes. Grado de protección IP-55. Aislamiento clase F. Doble frecuencia 50 Hz y 60 Hz. Rodamientos engrasados de por vida, garantizando una larga duración y un trabajo silencioso.



Applications:

The [e]MAGNUS pump is the new generation of public pool filtration pumps that incorporate a variable speed drive to a MAGNUS pump with extremely high energy efficiency permanent magnet synchronous motor. The software is specially developed for the automation of the pump. Thanks to a simple wizard, the necessary information is provided to the pump to have a fully operational installation. The System allows the programming of several daily filtration cycles with different operating speeds for each cycle. In installations with several pumps, the pumps will communicate with each other to work the same number of hours. In addition, it is capable of operating several pumps at the same time.

Main features:

- Very significant energy savings due to the fact that the pump can modify its working speed to the installation requirements.
- Different working speeds for different programming.
- Communication between several pumps.
- Alternating work by time.
- Extremely silent pump-inverter set.
- **Automatic sand filter cleaning system.**
- Consumption motor overload protection.
- Self-learning system for the constant search of the parameters that determine a dry operation.
- **New IPM sensorless permanent magnet brushless motor, which reduces the temperature of the motor in an extreme way, which extends the useful life of bearings and mechanical parts.**

Motor:

Synchronous permanent magnets. Degree of protection IP-55. Class F insulation. Double frequency 50 Hz and 60 Hz. Bearings greased for life, guaranteeing a long life and a silent work.



Datos técnicos / Technical data

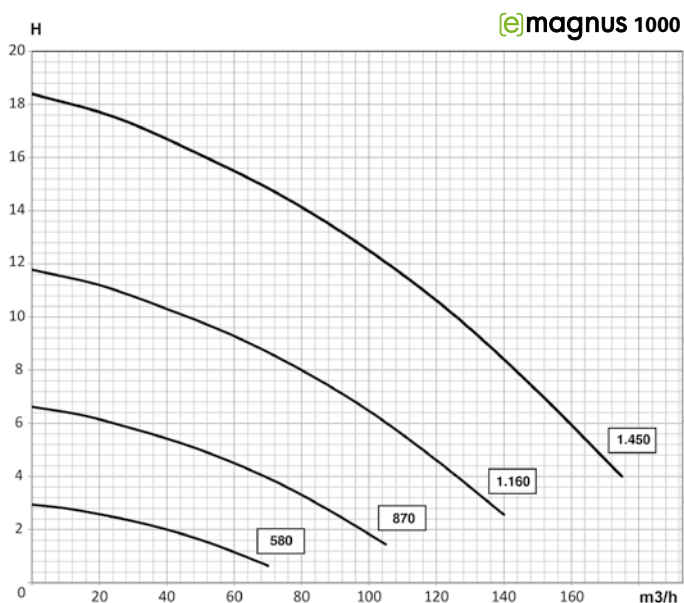
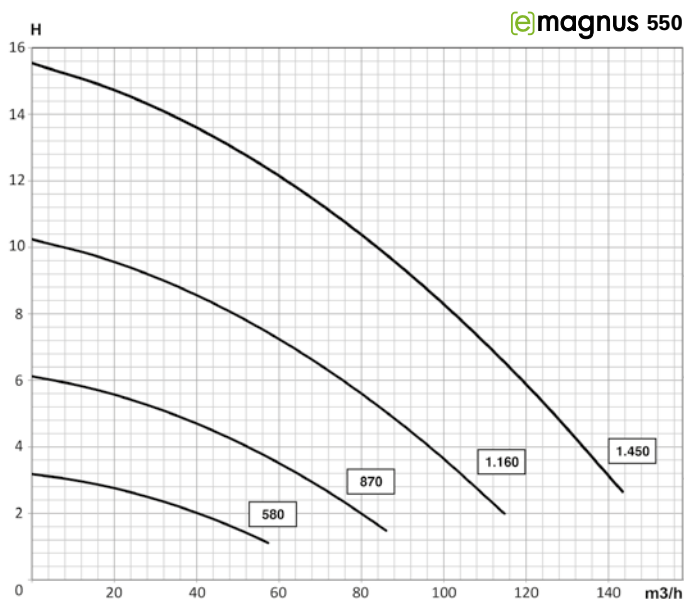

Tipo Type	Potencia		"A" III 400	Altura m.c.a. / Height w.c.m.							Diámetro		Mínimo diámetro de aspiración Minimum size of suction pipe
	HP	KW		6	8	10	12	14	16	18	ASP.	IMP	
Caudal m ³ /h / Flow m ³ /h													
[e]MAGNUS 550	5,5	4	8,8	123	104	84	30	57	-	-			160
[e]MAGNUS 1000	10	7,5	15,8	160	145	126	107	80	48	14	(4")	(4")	180

CF-2



VERT CF-2



a 2.850 r.p.m.

Aplicaciones:

Bombas para filtración con motor a 2.850rpm, que también permiten funcionar con variador de velocidad e]POOL.

Características constructivas:

Cuerpo bomba, soporte, prefiltro, acoplamiento y turbina en fundición de hierro de alta calidad con un pretratamiento de pintura epoxi-poliéster y secado al horno para darle más durabilidad y resistencia a la oxidación, sello mecánico en cerámica carbón, eje y cesto prefiltro en acero inoxidable AISI-316. Bombas monobloc que equipan un motor normalizado a través de un acoplamiento eje-bomba motor. **Bajo demanda pueden suministrarse con turbina de bronce.**

Motor:

IE3 motor asíncrono standard, cerrado de ventilación externa, apto para trabajo continuo. **Grado de protección IP-55. Aislamiento clase F (calentamiento "B") tropicalizados a 2.850 r.p.m. 50 Hz y bajo demanda 60 Hz.**



Applications:

Pumps for filtration with motor at 2.850rpm, which also allow operation with a e]POOL speed drive.

Constructive characteristics:

Pump body, pre-filter, coupling and impeller in cast iron. Shaft and pre-filter basket in AISI 316 stainless steel. Mechanical seal in carbon-ceramic. **On request, the impeller may be in bronze and the mechanical seal in silicium carbide or tungsten carbon.**

Motor:

IE3 standard asynchronous motor, sealed from external ventilation. **Its standard construction allows it to be replaced with another standard motor at any time and in any place. Protection IP-54. 2,850 rpm. 50-60 Hz.** Another advantage, is that totally standard spare motors are available anywhere in the world, at any time and of any brand.



Tipo Horizontal <i>Horizontal Type</i>	Tipo Vertical <i>Vertical Type</i>	HP	KW	"A"		Altura m.c.a. / Height w.c.m.										Ø ASP.	Ø IMP.
						6	8	10	12	14	16	18	20	22			
						230 V	400 V	Caudal m ³ /h / Flow m ³ /h									
CF-2 300	VERT CF-2 300	3	2,2	7,6	4,4	61	54	51	46	35	29					DN 80	DN 80
CF-2 400	VERT CF-2 400	4	3	10	5,8	70	64	59	55	49	42	30				DN 80	DN 80
CF-2 550	VERT CF-2 550	5,5	4	13,3	7,7	95	90	84	77	66	54	32				DN 125	DN 100
CF-2 551	VERT CF-2 551	5,5	4	13,3	7,7	128	121	107	90	69	30					DN 125	DN 100
CF-2 750	VERT CF-2 750	7,5	5,5	-	10,1	159	152	135	125	109	88	60				DN 125	DN 100
CF-2 1000	VERT CF-2 1000	10	7,5	-	13,7	175	166	158	147	135	119	98	68			DN 125	DN 100
CF-2 1250	VERT CF-2 1250	12,5	9,2	-	19,4	195	188	175	163	150	136	105	86			DN 125	DN 100
CF-2 1500	VERT CF-2 1500	15	11	-	19,4	200	197	193	183	170	155	132	110	87		DN 125	DN 100

HF-2



VERT HF-2



a 2.850 r.p.m.



Aplicaciones:

Bomba para filtración a gran altura con motor a 2.850 rpm, que también permiten funcionar con variador de velocidad [e]POOL.

Características constructivas:

Cuerpo bomba, soporte, prefiltro, acoplamiento y turbina en fundición de hierro de alta calidad con un pretratamiento de pintura epoxi-poliéster y secado al horno para darle más durabilidad y resistencia a la oxidación, sello mecánico en cerámica carbón, eje y cesto prefiltro en acero inoxidable AISI-316. Bombas monobloc que equipan un motor normalizado a través de un acoplamiento eje-bomba motor. **Bajo demanda pueden suministrarse con turbina de bronce.**

Motor:

IE3 motor asíncrono standard, cerrado de ventilación externa, apto para trabajo continuo. **Grado de protección IP-55. Aislamiento clase F (calentamiento "B") tropicalizados a 2.850 r.p.m. 50 Hz y bajo demanda 60 Hz.**



Applications:

Pumps for filtration at high altitude with motor at 2.850rpm, which also allow operation with a [e]POOL speed drive.

Constructive characteristics:

Pump body, pre-filter, coupling and impeller in cast iron. Shaft and pre-filter basket in AISI 316 stainless steel. Mechanical seal in carbon-ceramic. **On request, the impeller may be in bronze and the mechanical seal in silicium carbide or tungsten carbon.**

Motor:

IE3 standard asynchronous motor, sealed from external ventilation. **Its standard construction allows it to be replaced with another standard motor at any time and in any place. Protection IP-54. 2,850 rpm. 50-60 Hz.** Another advantage, is that totally standard spare motors are available anywhere in the world, at any time and of any brand.

Tipo Horizontal Horizontal Type	Tipo Vertical Vertical Type	HP	KW	"A"		Altura m.c.a. / Height w.c.m.										Ø ASP.	Ø IMP.
						230 V	400 V	18	20	22	24	25	27	30	32		
Caudal m³/h / Flow m³/h																	
HF-2 308	VERT HF-2 308	3	2,2	7,6	4,4			18	16	14	12					DN-65	DN-32
HF-2 408	VERT HF-2 408	4	3	10	5,8			29	26	24	22	18	6			DN-65	DN-32
HF-2 558	VERT HF-2 558	5,5	4	13,3	7,7			36	34	33	30	25	21	12		DN-65	DN-32
HF-2 758	VERT HF-2 758	7,5	5,5	-	10,1				54	52	48	41	32			DN-65	DN-40
HF-2 1008	VERT HF-2 1008	10	7,5	-	13,7	102	92	83	64	62	42					DN-65	DN-50
HF-2 1208	VERT HF-2 1208	10	7,5	-	13,7				88	84	74	56	36			DN-65	DN-50
HF-2 1508	VERT HF-2 1508	15	11	-	19,4				117	113	102	78	54			DN-80	DN-65
HF-2 2008	VERT HF-2 2008	20	15	-	26,5			165	140	125	118	114	85			DN-100	DN-80
HF-2 2508	VERT HF-2 2508	25	18,5	-	32,5			240	225	200	190	175	145	125	72	DN-100	DN-80

PARA MÁS INFORMACIÓN CONSULTAR NUESTRO CATÁLOGO TÉCNICO DE BOMBAS PARA PISCINAS
CHECK OUR TECHNICAL CATALOGUE OF SWIMMING POOL PUMPS FOR MORE INFORMATION

CF-4



VERT CF-4



Aplicaciones:

Bombas para filtración con motor a 1.450rpm, que también permiten funcionar con variador de velocidad le]POOL.

Características constructivas:

Cuerpo bomba, soporte, prefiltro y turbina en fundición de hierro. Eje-acoplamiento y cesto prefiltro en acero inoxidable. Cierre mecánico en carbón-carburo de silicio. Bombas monobloc que equipan un motor normalizado a través de un acoplamiento eje-bomba motor.

Bajo demanda pueden suministrarse con turbina de bronce.

Motor:

IE3 motor asíncrono standard, cerrado de ventilación externa, apto para trabajo continuo. **Grado de protección IP-55. Aislamiento clase F (calentamiento "B") tropicalizados a 1.450 r.p.m. 50 Hz y bajo demanda 60 Hz. Estas bombas no equipan contrabridas de serie.**

a 1.450 r.p.m.



Applications:

Pumps for filtration with motor at 1.450rpm, which also allow operation with a le]POOL speed drive.

Constructive characteristics:

*Pump body, support, pre-filter and impeller in cast iron. Shaft-coupling and pre-filter sieve in AISI 316 stainless steel. Mechanical seal in carbon - silicium carbide. **On demand the CF-4 pump range may be supplied with bronze impeller** (standard in cast iron) or with other versions of mechanical seal, such as : tungsten carbon, aisi 316, epdm, viton etc...*

Motor:

*IE3 standard asynchronous motor, sealed from external ventilation. Its standard construction allows it to be replaced with another standard motor at any time and in any place. **Protection IP-55. 1,450 rpm. 50-60 Hz.***

Tipo Horizontal Horizontal Type	Tipo Vertical Vertical Type	HP	KW	"A"		Altura m.c.a. / Height w.c.m.										Ø ASP.	Ø IMP.	
						9	10	12	14	15	16	18	20	21				
				230 V	400 V	Caudal m ³ /h / Flow m ³ /h												
CF-4 300	VERT CF-4 300	3	2,2	7,6	4,4	54	50	44	30	20							DN 65	DN 50
CF-4 400	VERT CF-4 400	4	3	10	5,8		70	67	50	36	20						DN 80	DN 65
CF-4 550	VERT CF-4 550	5,5	4	13,3	7,7			84	72	66	54	20					DN 80	DN 65
CF-4 552	VERT CF-4 552	5,5	4	13,3	7,7	120	110	78	28								DN 100	DN 80
CF-4 750	VERT CF-4 750	7,5	5,5	-	10,1			124	104	90	72						DN 100	DN 80
CF-4 1000	VERT CF-4 1000	10	7,5	-	13,7		210	175	130	90	60						DN 125	DN 100
CF-4 1500	VERT CF-4 1500	15	11	-	19,4			215	200	190	180	150	120	60			DN 125	DN 100
CF-4 2000	VERT CF-4 2000	20	15	-	26,5			320	300	275	260	210	102				DN 150	DN 125
CF-4 2500	VERT CF-4 2500	25	18,5	-	32,5				360	340	310	280	220	190			DN 150	DN 125

PARA MÁS INFORMACIÓN CONSULTAR NUESTRO CATÁLOGO TÉCNICO DE BOMBAS PARA PISCINAS
CHECK OUR TECHNICAL CATALOGUE OF SWIMMING POOL PUMPS FOR MORE INFORMATION

HF-4



Aplicaciones:

Bombas para filtración a gran altura con motor a 1.450rpm, que también permiten funcionar con variador de velocidad [e]POOL.

Características constructivas:

Cuerpo bomba, soporte, prefiltro y turbina en fundición de hierro. Eje-acoplamiento y cesto prefiltro en acero inoxidable. Cierre mecánico en carbón-carburo de silicio. Bombas monobloc que equipan un motor normalizado a través de un acoplamiento eje-bomba motor. **Bajo demanda pueden suministrarse con turbina de bronce.**

Motor:

IE3 motor asíncrono standard, cerrado de ventilación externa, apto para trabajo continuo. **Grado de protección IP-55. Aislamiento clase F (calentamiento "B") tropicalizados a 1.450 r.p.m. 50 Hz y bajo demanda 60 Hz.**



VERT HF-4



Applications:

Pumps for filtration at high altitude with motor at 1.450rpm, which also allow operation with a [e]POOL speed drive.

Constructive characteristics:

Pump body, support, pre-filter and impeller in cast iron. Shaft-coupling and pre-filter sieve in AISI 316 stainless steel. Mechanical seal in carbon - silicon carbide. **On demand the CF-4 pump range may be supplied with bronze impeller (standard in cast iron) or with other versions of mechanical seal, such as: tungsten carbon, aisi316, epdm, viton etc...**

Motor:

IE3 standard asynchronous motor, sealed from external ventilation. It's standard construction allows it to be replaced with another standard motor at any time and in any place. **Protection IP-55. 1,450 rpm. 50-60 Hz.**

Tipo Horizontal Horizontal Type	Tipo Vertical Vertical Type	HP	KW	"A"		Altura m.c.a. / Height w.c.m.								Ø ASP.	Ø IMP.	
						18	20	22	24	25	27	30	32			35
				230 V	400 V	Caudal m³/h / Flow m³/h										
HF-4 308	VERT HF-4 308	3	2.2	7,6	4,4	23	13								DN-65	DN-40
HF-4 408	VERT HF-4 408	4	3	10	5,8		27	19							DN-65	DN-40
HF-4 558	VERT HF-4 558	5,5	4	13,3	7,7	51	43	33							DN-65	DN-50
HF-4 758	VERT HF-4 758	7,5	5,5	-	10,1	75	64	50	12						DN-80	DN-65
HF-4 1008	VERT HF-4 1008	10	7,5	-	13,7		85	75	63	54					DN-80	DN-65
HF-4 1508	VERT HF-4 1508	15	11	-	19,4			110	90	72					DN-100	DN-80
HF-4 2008	VERT HF-4 2008	20	15	-	26,5		190	160	120	102					DN-125	DN-100
HF-4 2508	VERT HF-4 2508	25	18,5	-	32,5				170	160	140	120	30		DN-125	DN-100
HF-4 3008	VERT HF-4 3008	30	22	-	38,5				210	200	190	160	135	102	DN-125	DN-100

HIERRO CAST IRON



Generalidades:

Bridas de entrada y salida según norma DIN 2501 con conexiones a partir de DN 65 (2 1/2") hasta DN 200 (8") provistos de 3-4 pomos de cierre (según modelos) para la perfecta estanqueidad de la tapa.

Características constructivas:

Vaso y tapa prefiltro en fundición de hierro con un pre-tratamiento de pintura epoxi-poliéster y secado al horno para darle más durabilidad y resistencia a la oxidación, con pomos y cesta en acero inoxidable AISI-316.

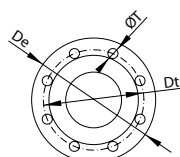
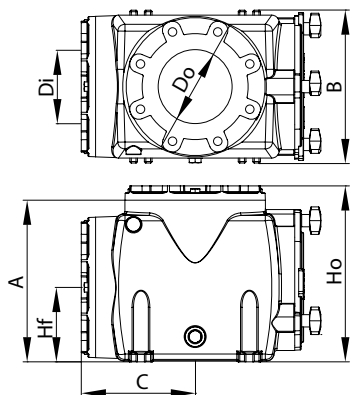

Generals:

Inlet and outlet clamps according to DIN 2501 with connections from DN 65 (2 1/2") to DN 200 (8") with 3-4 closing handles (depending on model) for a perfect lid seal.

Constructive characteristics:

Pot and pre-filter lid in cast iron. With epoxy-polyester paint. Prefilter basket and prefilter handles in stainless steel AISI 316.

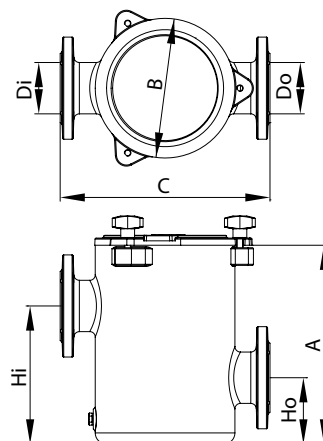

Tipo/Type	Di	Do	Hi	Ho	A	B	C	De	Dt	ØT	Agujeros Holes
F 65/65	65	65	250	120	360	253	380	185	145	18	4
F 80/80 (4T)	80	80	250	120	360	253	380	200	160	18	4
F 80/80 (8T)	80	80	250	120	360	253	380	200	160	18	8
F 100/100	100	100	270	155	360	253	380	222	180	18	8
F 125/125	125	125	270	155	360	253	380	250	210	18	8
F 150/150	150	150	380	190	500	330	460	285	240	22	8
F 200/200	200	200	380	190	500	330	460	340	295	22	8
V 65/65	65	65	151	357	328	310	231	285	M16	M16	4
V 80/80	80	80	151	357	328	310	231	285	M16	M16	8
V 100/100	100	100	151	357	328	310	231	285	M16	M16	8
V 125/125	125	125	151	357	328	310	231	285	M16	M16	8
V 150/150	150	150	151	357	328	310	231	285	M20	M20	8

INOX

acero inoxidable AISI-316L
stainless steel AISI-316L



IV



Generalidades:

Bridas de entrada y salida según norma DIN 2501 con conexiones a partir de DN-65 (2 1/2") hasta DN 250 (10") provistos de 5 pomos de cierre en AISI-316 para la perfecta estanqueidad de la tapa.

Características constructivas:

Completamente en acero inoxidable AISI-316L.



Generals:

Inlet and outlet clamps according to DIN 2501 with connections from DN-65 (2 1/2") to DN 200 (8") with 5 closing handles in AISI-316 for a perfect lid seal.

Constructive characteristics:

All in stainless steel AISI-316L.

IH



Datos embalage
Packaging data

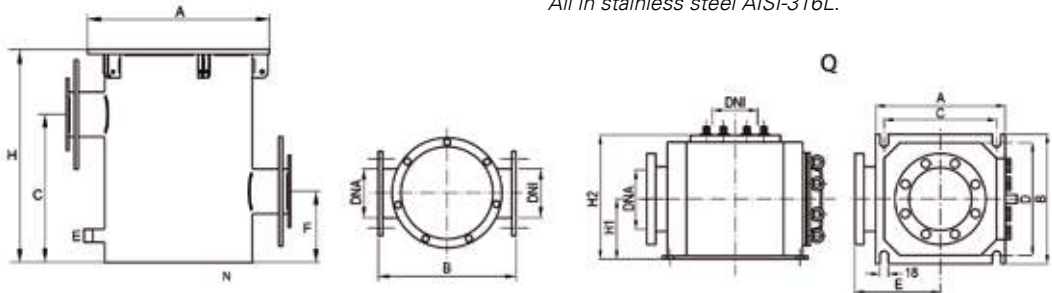

Tipo/Type	A	B	C	E	F	H	H1	H2	DNA	DNI	Peso Kg.	Volumen Lts.
IH 65/65	308	380	250	1/2"	120	430			65	65	26	17
IH 80/80	308	380	250	1/2"	120	430			80	80	28	17
IH 100/100	308	380	270	1/2"	155	430			100	100	40	17
IH 125/125	308	380	270	1/2"	155	430	460		125	125	48	17
IH 150/150	398	460	380	1/2"	190	610			150	150	52	48
IH 200/200	398	460	380	1/2"	190	610			200	200	58	48
IV 100/80	370	370	330	260			150	310	100	80	34,2	42
IV 125/100	370	370	330	260			150	310	125	100	37,4	42
IV 150/125	450	450	400	290			185	380	150	125	53,9	77
IV 250/150	435	535	390	290			215	440	250	150	72,6	105

BR-2

bronce / bronze



Aplicaciones:

Bomba centrífuga en bronce marino de gran caudal con motor a 2.850 r.p.m., que incorporan un prefiltro en la aspiración, lo cual hace de ellas la bomba ideal para grandes equipos de filtración, especialmente en instalaciones con agua salada.

Características constructivas:

Cuerpo bomba, soporte, prefiltro y turbina en bronce. Eje y cesto prefiltro en acero inoxidable AISI 316. Cierre mecánico en carbón-cerámica y acero inoxidable AISI 316.

Bombas monobloc que equipan un motor normalizado a través de un acoplamiento eje-bomba motor.

Motor:

IE3 motor asíncrono standard, cerrado de ventilación externa, apto para trabajo continuo.

Grado de protección IP-55. Aislamiento clase F (calentamiento "B") tropicalizados a 2.850 r.p.m. 50 Hz y bajo demanda 60 Hz.



Applications:

A large volume centrifugal pump, to which a pre-filter has been applied in the inlet, making these the ideal pumps for large filtering units. The bronze version is ideal for salt water and automatic pool systems that use salt electrolysis as a means of disinfecting.

Constructive characteristics:

Pump body, pre-filter, support and impeller DIN-1705 RG 5 bronze (G-CuSn 5 ZnPb). Shaft, pre-filter basket and bolts in AISI 316 stainless steel. Cast iron coupling. Mechanical seal in carbon-ceramic and AISI 316 stainless steel.

On request, these pumps may be supplied in any other bronze alloy.

Motor:

IE3 standard asynchronous motor, sealed from external ventilation. **Its standard construction allows it to be replaced with another standard motor at any time and in any place. Protection IP-54. 2,850 rpm. 50-60 Hz.**

Tipo Type	HP	KW	R.P.M	"A"		Altura m.c.a. / Height w.c.m.								Ø ASP.	Ø IMP.	
						6	8	10	12	14	16	18	20			22
				230 V	400 V	Caudal m³/h / Flow m³/h										
BR-2 300	3	2,2	2.850	7,6	4,4	61	54	51	46	35	29				DN 80	DN 80
BR-2 400	4	3	2.850	10	5,8	70	64	59	55	49	42	30			DN 80	DN 80
BR-2 550	5,5	4	2.850	13,3	7,7	95	90	84	77	66	54	32			DN 125	DN 100
BR-2 551	5,5	4	2.850	13,3	7,7	128	121	107	90	69	30				DN 125	DN 100
BR-2 750*	7,5	5,5	2.850	17,5	10,1	159	152	135	125	109	88	60			DN 125	DN 100
BR-2 1000*	10	7,5	2.850	-	13,7	175	166	158	147	135	119	98	68		DN 125	DN 100
BR-2 1250*	12,5	9,2	2.850	-	19,4	195	188	175	163	150	136	105	86		DN 125	DN 100
BR-2 1500*	15	11	2.850	-	19,4	200	197	193	183	170	155	132	110	87	DN 125	DN 100

En los modelos de 3 y 4 CV recomendamos la instalación con tubo de 90 mm. (For 3-4 HP we recommend minimum 90 mm. pipe)

* Voltaje de Serie 400/690 V (bajo demanda 230/400 V) / *Standard voltage 400/690 V (under demand 230/400 V)

PARA MÁS INFORMACIÓN CONSULTAR NUESTRO CATÁLOGO TÉCNICO DE BOMBAS PARA PISCINAS
CHECK OUR TECHNICAL CATALOGUE OF SWIMMING POOL PUMPS FOR MORE INFORMATION

POOLMATIC



Aplicaciones:

Bombas centrifugas multicelulares horizontales, extremadamente silenciosa especialmente concebida para trabajar con limpiafondos automáticos ya sea en piscinas con agua clorada como con agua tratada con electrolisis salina.

Características constructivas:

Cuerpo bomba, turbinas y difusores en tecnopolimero, disco porta sello y eje en Acero Inoxidable AISI 316, cierre mecánico en carbon cerámica.

Motor:

IE3 asincrono, cerrado de ventilación externa. Aislamiento clase F.

Maxima temperatura ambiente: 40° C

Maxima temperatura del agua: +40° C



Applications:

Multistage centrifugal pump, extremely silent a specially designed to work with automatic pool cleaners. This pump can be used rather with chlorinated water or with pools treated with salt electrolisis.

Constructive characteristics:

Pump body, impellers & diffusers in techno polymer. Pump body lid and shaft in stainless steel AISI 316, mechanical seal in carbon ceramic.

Motor:

IE3 asynchronous, close with external ventilation. Isolation type F. 2,850 rpm. 50Hz

Maximum ambient temperature: 40° C

Maximum water temperature: +40° C

Tipo Type	Con. µF	Potencia		"A"			Caudal m ³ /h / Flow m ³ /h								Diámetro		
		HP	KW	II 230	III 230	III 400	0	0,6	1,2	1,8	2,4	3	3,6	4,2	4,8	ASP.	IMP.
							Altura m.c.a. / Height w.c.m.										
POOLMATIC 30/50 M	12,5	0,75	0,55	3,9	-	-	42,2	40,25	38,2	36,2	33,8	30	24,8	19,5	14	1"	1"
POOLMATIC 30/50 T	-			-	2,8	1,6											
POOLMATIC 40/50 M	25	1	0,75	5,3	-	-	57,7	55,3	52,8	50,1	47,1	42,7	35,8	28	19,2	1"	1"
POOLMATIC 40/50 T	-			-	3,8	2,2											

BRAVUS

natación contra corriente
countercurrent swimming



también disponible VSD BRAVUS
also available VSD BRAVUS



Bravus:

- Polipropileno + Fibra de Vidrio
- AISI-316 stainless steel shaft
- Rodete en Noryl
- Sello mecánico en acero inoxidable AISI-316
- Ideal para instalación de natación contracorriente

Características:

- Doble conexión, rosca y racores
- Rosca hembra 3", racor encolar DN90
- **Pintura por cataforesis**
- Tornillería en acero inoxidable AISI-316
- Motor asíncrono IE3 a 2900 rpm (3450 rpm @ 60 Hz)
- Rodamientos lubricados de por vida
- Grado IP-55, Aislamiento clase F
- Máxima temperatura del agua: +40°C



Bravus:

- *Polypropylene + Fiberglass*
- *Eje en acero inoxidable AISI-316*
- *Impeller in Noryl*
- *Mechanical seal in stainless steel AISI-316*
- *Ideal for countercurrent swimming installation*

Features:

- *Double connection, thread and fittings*
- *3" female thread, fittings glue DN90*
- **Cataphoresis painting**
- *Stainless steel screws AISI-316*
- *IE3 asynchronous motor at 2900 rpm (3450 rpm @ 60 Hz)*
- *Lubricated bearings for life*
- *IP-55 Grade, Class F Insulation*
- *Maximum water temperature: + 40°C*

Tipo / Type	HP	kW	A			RPM	Altura m.c.a / Height w.c.m						ASP / IMP	
			II	III	III		6	8	10	12	14	16		18
			230	230	400		Caudal m³/h / Flow m³/h							
BRAVUS 300 M/T	3	2,2	16	9,4	5,3	2900	59	54	47	39	28	16	-	3" PVC90
BRAVUS 400 T	4	3	-	12,5	6,9	2900	68	63	58	52	45	36	23	
BRAVUS 550 T	5,5	4	-	-	8,8	2900	78	74	70	65	59	50	39	

KONTRA

natación contra corriente
countercurrent swimming



también disponible VSD KONTRA
also available VSD KONTRA



Kontra:

- Polipropileno + Fibra de Vidrio
- AISI-316 stainless steel shaft
- Rodete en Noryl o bronce, según modelo
- Sello mecánico en acero inoxidable AISI-316
- Ideal para instalación de natación contracorriente

Características:

- Conexión bridas DN110 (4")
- Pintura por catáforesis
- Tornillería en acero inoxidable AISI-316
- Motor asíncrono IE3 a 1450 rpm (1750rpm @ 60Hz)
- Rodamientos lubricados de por vida
- Grado IP-55, Aislamiento clase F
- Máxima temperatura del agua: +40°C

Kontra:

- Polypropylene + Fiberglass
- Eje en acero inoxidable AISI-316
- Impeller in Noryl or bronze, depending on type
- Mechanical seal in stainless steel AISI-316
- Ideal for countercurrent swimming installation

Features:

- Flanges connection DN110 (4")
- Cataphoresis painting
- Stainless steel screws AISI-316
- IE3 asynchronous motor at 1450rpm (1750rpm @ 60Hz)
- Lubricated bearings for life
- IP-55 Grade, Class F Insulation
- Maximum water temperature: + 40°C



1.450 r.p.m. de 2,5 a 10 HP
2.850 r.p.m. 12,5 y 15 HP



Tipo Type	Potencia		"A"			r.p.m.	Altura m.c.a. / Height w.c.m.										Diámetro			
	HP	KW	III 230	III 400	III 690		6	8	10	12	14	16	18	20	22	ASP	IMP			
																	Caudal m ³ /h / Flow m ³ /h			
KONTRA-4 250	2,5	1,8	8,5	4,9	-	1.450	53	43	32	18										
KONTRA-4 300	3	2,2	9,4	5,3	-	1.450	62	54	43	26	10									
KONTRA-4 400	4	3	12,5	6,9	-	1.450	74	66	56	42	29	14								
KONTRA-4 550	5,5	4	15,3	8,8	-	1.450	123	104	84	57	30							110	110	
KONTRA-4 750	7,5	5,5	-	12	7	1.450	143	127	107	85	57	12						(4")	(4")	
KONTRA-4 1000	10	7,5	-	15,8	9,2	1.450	160	145	126	107	80	48	14							
KONTRA-2 1250	12,5	9,2	-	18,5	10,7	2.850		167	152	136	118	99	80	47						
KONTRA-2 1500	15	11	-	20,9	12	2.850		188	177	162	146	130	112	92	66					

PARA MÁS INFORMACIÓN CONSULTAR NUESTRO CATÁLOGO TÉCNICO DE BOMBAS PARA PISCINAS
CHECK OUR TECHNICAL CATALOGUE OF SWIMMING POOL PUMPS FOR MORE INFORMATION

SOPLANTES



Aplicaciones:

Bombas diseñadas para baños de burbujas, tratamiento de aguas, secado de coches, ventilación/aspiración de polvo, etc...

Características constructivas:

Bombas soplantes construidas íntegramente en fundición de aluminio y adecuadas para el funcionamiento en continuo. **Con turbinas de canal lateral de etapa simple, sin necesidad de ningún tipo de mantenimiento. Incorpora silenciadores tanto en la aspiración como en la impulsión.**

Motor:

Asíncorno hermético de ventilación externa. Protección térmica incorporada. Las versiones monofásicas incorporan condensador. Grado de protección IP-55. Aislamiento clase F.



Applications:

Pumps designed for bubble baths, water treatment, car drying, ventilation / dust extraction, etc...



Constructive characteristics:

Blower pumps constructed entirely in aluminum and suitable for continuous operation. **Single stage side channel pumps, without any maintenance. Includes inlet and outlet silencers.**

Motor:

Sealed asynchronous motor with external ventilation. Built-in thermal protection. Single phase versions includes capacitor. IP-55 protection. Isolation class F.

Tipo Type	Potencia		"A"			Caudal máximo Max. Flow (m ³ /h)	Max. Vacío / Pres. Pres. Max (mbar)	Nivel sonoro Noise (db)	Conexiones Connections	Aplicaciones Applications
	HP	KW	II 230	III 230	III 400					
80-370 M	0,6	0,4	2,7	-	-	80	-120/130	53	1 1/4"	1Spa pequeño
80-400 T			-	2,6	1,5					
140-800 M	1,2	0,85	5	-	-	145	-160/160	63	1 1/2"	10 JETS
140-850 T			-	4,2	2,4					
140-111 M	1,8	1,3	7,3	-	-	145	-170/200	63	1 1/2"	10 JETS
140-131 T			-	6,6	3,8					
210-111 M	1,8	1,3	7,3	-	-	210	-170/170	64	2"	20 JETS
210-131 T			-	6,6	3,8					
210-151 M	2	1,5	9	-	-	210	-210/220	64	2"	20 JETS
210-161 T	2,2	1,6	-	7,5	4,3	210	-210/220	64	2"	20 JETS
315-221 T	3	2,2	-	10	5,8	318	-230/230	69	2"	30 JETS
315-301 T	4	3	-	12,5	7,2	318	-260/280	69	2"	30 JETS

PL



DOSING KIT



- Bomba de pequeñas dimensiones.
- Caudal constante regulable manualmente.
- Esta bomba es de diafragma activado por solenoide.
- El diafragma es la única pieza móvil.
- Incorpora válvulas de Vitón.
- Equipadas con tubos y accesorios para conexiones de aspiración e impulsión.
- **Voltage 230V 50/60Hz.**

Serie PL:

El potenciómetro de regulación de caudal está marcado con doble escala seleccionable por conmutador. La escala azul para regulación de 0 a 100%. La escala roja es de más precisión para regulación de de 0 a 20%.

Serie Kit Dosif Ph/Rx:

Kit para control de PH y Redox (Rx) para piscinas domésticas. La bomba peristáltica monitoriza en todo momento el nivel de Ph o de Redox en la piscina, ajustando la frecuencia de bombeo a la necesidad requerida.



- A small pump.
- Constant flow regulable by hand.
- This pump has a solenoid operated diaphragm, which is the only moving part.



- Viton valves.
- Fitted with pipes and accessories for suction and drive connections.
- **Voltage 230V 50/60Hz.**

PL series:

The flow regulation potentiometer is marked with a double scale that can be selected by a switch. The blue scale for regulation from 0 to 100%. The red scale is for more precision for regulation from 0 to 22%.

Ph/Rx Dosif kit series:

Kit of pump and accessories to control the PH or Rx for domestic pools. The peristaltic pump controls all the time the PH or Rx values, and adjust the pumping frequency to obtain the requested value.

Tipo Type	Pot. Abs. Watt	Volt.	A	Caudal máx. Max. Flow lts./h.	Presion máx. Max. Pressure bar	N.º Impulsos x min.	Alt. Asp. Suction Height
PL 23	40	II 230	0,18	5	7	100	2
PL 50	75	II 230	1,1	10	5	110	2
PL 75	140	II 230	2	20	5	160	2

Tipo Type	Pot. Abs. Watt	Caudal máx. Max. Flow lts./h.	Presion máx. Max. Pressure bar	Regulación Regulation PH	Regulación Regulation Redox (Rx)
DOSING KIT Ph	15	1,5	1,5	5 - 9	-
DOSING KIT Rx	15	1,5	1,5	-	300 - 900 mV

FILTRO DOMÉSTICO



Bajo demanda con tapa roscada transparente

Transparent screw cover under demand



Filtro laminado para piscina doméstica fabricado en fibra de vidrio reforzado. Resistente a los rayos UV viene equipado con manómetro y válvula selectora de 6 vías.



Laminated filter for private pools made with reinforced fiber glass. UV resistant includes a manometer and 6 way valve.

Modelo <i>Model</i>	Ø	Conexión <i>Connection</i>	Sup. Filtrante <i>Filtering Surface</i>	Caudal / Flow	Arena / Sand	Peso / Weight
	mm		m ²	v=50 m ³ /h/m ²	(kg)	(kg)
SUN 400	400	1,5"	0,13	6,5	50	12
SUN 510	510	1,5"	0,20	10,2	100	18
SUN 620	620	1,5"	0,30	15,1	150	23,5
SUN 680	680	2"	0,36	18,14	175	27
SUN 750	750	2"	0,44	22	225	33
SUN 900	900	2"	0,64	31,8	325	42

KITS DE FILTRACIÓN



Incluyen bomba OPTIMA monofásica junto con filtro laminado con válvula superior de 6 vías. Se incluye la base en fibra de vidrio y el kit de unión.



Includes OPTIMA single phase pump and laminate filter with 6 ways top valve. Also includes the fiberglass base and the union kit.



Modelo <i>Model</i>	Ø	Conexión <i>Connection</i>	Sup. Filtrante <i>Filtering Surface</i>	Caudal <i>Flow</i>	Bomba <i>Pump</i>	Arena <i>Sand</i>	Peso <i>Weight</i>
	mm		m ²	v=50 m ³ /h/m ²	hp	(kg)	(kg)
SUN KIT 25	400	1,5"	0,13	6,5	0,25	50	19
SUN KIT 33	400	1,5"	0,13	7,5	0,33	50	19
SUN KIT 50	510	1,5"	0,20	8,5	0,50	100	26
SUN KIT 75	510	1,5"	0,20	10,2	0,75	100	26
SUN KIT 100	620	1,5"	0,30	15,1	0,95	150	29

FILTRO PISCINA PÚBLICA



Filtro laminado para piscina pública fabricado en fibra de vidrio reforzado. Resistente a los rayos UV viene equipado con válvula de seguridad de sobre presión. Brazo colector y lecho filtrante de 1 metro. Presión de trabajo 2,5 bar. Bajo demanda se puede suministrar con:

- **Lecho filtrante de 1,2 metros**
- Placa de crepinas
- Visor
- Boca de hombre
- Presión 4 bar



Commercial laminated filter for public pool made with reinforced fiberglass. UV resistant includes a security valve for over pressure. Arm collector and filtration bed depth of 1 meter. Pressure 2,5 bar. Under demand can be supplied with:

- **Filtration bed depth of 1,2 meters**
- Nozzle plate
- Side glass
- Man hole
- Pressure 4 bar

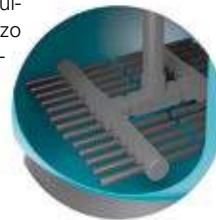

STANDARD



OPCIONAL



Modelo Model	∅	Conexión Connection	Sup. Filtrante Filtering Surface	Velocidad Speed	Caudal Flow	Grava / Gravel (1-2 mm)	Arena / Sand (0,4-0,8 mm)
	mm	mm	m ²	m ³ /h/m ²	m ³ /h	kg	(kg)
SUN 1050	1050	63	0,87	20	17	200	1100
	1050	75	0,87	30-40	26-34	200	1100
	1050	90	0,87	50	43	200	1100
SUN 1200	1200	75	1,13	20-30	23-34	250	1450
	1200	90	1,13	40-50	45-56	250	1450
SUN 1400	1400	75	1,54	20	31	375	2050
	1400	90	1,54	30	46	375	2050
	1400	110	1,54	40-50	62-77	375	2050
SUN 1600	1600	90	2,01	20	40	500	2350
	1600	110	2,01	30-40	60-80	500	2350
	1600	125	2,01	50	100	500	2350
SUN 1800	1800	90	2,54	20	51	750	3350
	1800	110	2,54	30	76	750	3350
	1800	125	2,54	40	102	750	3350
	1800	140	2,54	50	125	750	3350
SUN 2000	2000	110	3,14	20	63	1000	4300
	2000	125	3,14	30	94	1000	4300
	2000	140	3,14	40	126	1000	4300
	2000	160	3,14	50	157	1000	4300

ALDARA MINI



Descripción producto:

Cascada fabricada en acero inoxidable calidad AISI-316L (EN 1.4404).

- Fácil instalación, no precisa de anclaje adicional.
- Incorpora conexión hembra de 1 ½”.
- El caudal aconsejado para un uso óptimo es de 18 m³/h
- Tornillería de instalación incluida.
- **Bomba recomendada Winner 100.**
- **Versión PREMIUM** con acabado electropulido bajo demanda.



Product descriptions:

Water fall made in stainless Steel AISI-316L (EN 1.4404) quality.

- Easy installation, anchorage not needed.
- 1 ½ ” female threaded connexion included.
- 18 m³/h recommended Flow rate for optimum performance.
- Installation screws included.
- **Recommended pump Winner 100.**
- **PREMIUM version** with electropolished finish on demand.

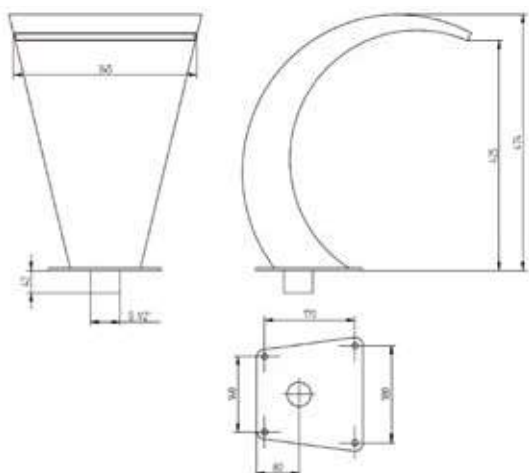

ALDARA



Descripción producto:

Cascada fabricada en acero inoxidable calidad AISI-316L (EN 1.4404).

- Anclaje incluido para su funcionamiento.
- Conexión hembra de 2"
- Caudal recomendado para uso óptimo es de 21 m³/h.
- **Bomba recomendada Winner 150.**
- **Versión PREMIUM** con acabado electropulido bajo demanda.



Product descriptions:

Water fall made in stainless Steel AISI-316L (EN 1.4404) quality.

- Anchor included for operation.
- 2" female threaded connection.
- Suggested Flow rate for an optimum performance of 21 m³/h.
- **Recommended pump Winner 150.**
- **PREMIUM version** with electropolished finish on demand.

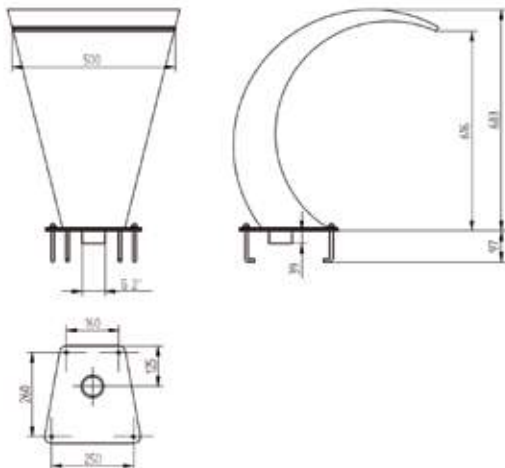

RIMINI



Descripción producto:

Cascada fabricada en acero inoxidable calidad AISI-316L (EN 1.4404).

- No se requiere anclaje para su correcto funcionamiento.
- Caudal recomendado para uso óptimo es de 21 m³/h.
- Conexión rosca macho de 2".
- **Bomba recomendada Winner 150.**
- **Versión PREMIUM** con acabado electropulido bajo demanda.



Product descriptions:

Water fall made in stainless Steel AISI-316L (EN 1.4404) quality.

- Anchoring is not required for proper operation.
- Suggested Flow rate for an optimum performance of 21 m³/h.
- Male thread connection of 2".
- **Recommended pump Winner 150.**
- **PREMIUM version** with electropolished finish on demand.



conexión macho 2"
2" male thread

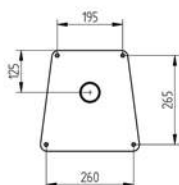
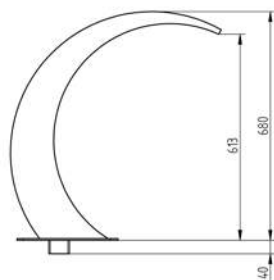
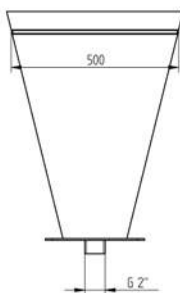

RIVA



Descripción producto:

El nuevo cañón de agua modelo RIVA es el nuevo miembro de la familia Saci Wellness diseñado y fabricado bajo los más altos estándares de calidad a la vez que facilita una instalación sencilla y fiable.

Características principales:

- Fabricado en acero inoxidable calidad AISI-316L.
- Fácil instalación, no necesita anclaje.
- Incorpora rosca de 1 ½" para conexión directa a tubería.
- No necesita bomba adicional, debido a su caudal (7m³/h) puede conectarse al sistema de retorno de la piscina.
- Dos versiones disponibles según el efecto buscado; boca plana y boca circular.
- Incluye embellecedor.



Product descriptions:

The new water feature Riva is the new member of the Saci Wellness family designed and manufactured under the highest quality standards while facilitating simple and reliable installation.

Main features:

- Made in stainless steel 316L quality.
- Easy installation, anchorage no needed.
- 1 ½" connection for a "pug & play" with pipe.
- Extra pump no needed; can be connected to de swimming pool water return due to the flow (7 m³/h).
- 2 options according the effect; with flat or circular nozzle.
- Escutcheon included.

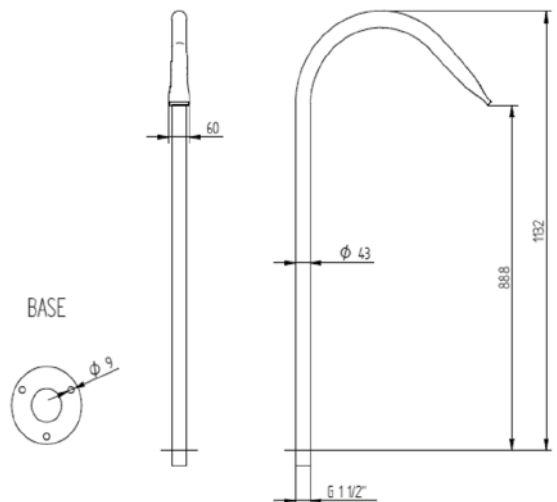

DOLCE



Descripción producto:

Cañón de agua fabricado en acero inoxidable calidad AISI-316L (EN 1.4404). Anclaje incluido con conexión de 2".

- 350mm de boca y 18 m³/h.
- **Bomba recomendada Winner 100.**
- **Versión PREMIUM** con acabado electropulido bajo demanda



Product descriptions:

Water cannon made in stainless Steel AISI-316L (EN 1.4404) quality.

Anchorage included with a 2" connexion.

- 350mm of mouth and 18 m³/h flow.
- **Recommended pump Winner 100.**
- **PREMIUM version** with electropolished finish on demand

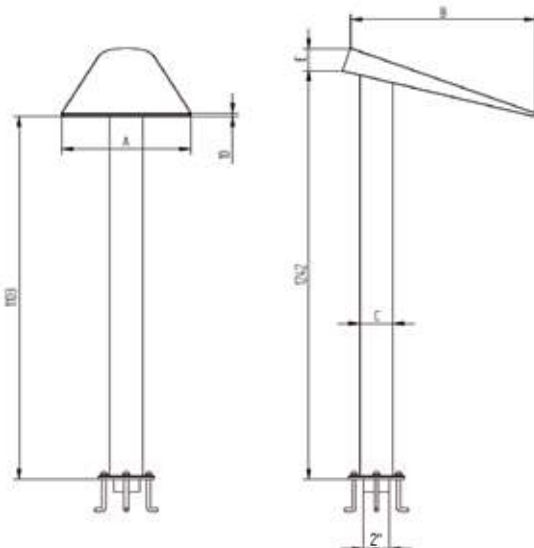

HEAT-SS

	K1, K4	K2, K3
B45	G ^{3/4"}	G ^{1"}
B70	G ^{3/4"}	G ^{1 1/2"}
B130	G ^{3/4"}	G ^{1 1/2"}
B180	G ^{1"}	G ^{1 1/2"}
B250	G ^{1"}	G ^{1 1/2"}
B300	G ^{1"}	G ^{1 1/2"}
B500	G ^{1"}	G ^{2"}
B1000	G ^{2"}	G ^{2"}

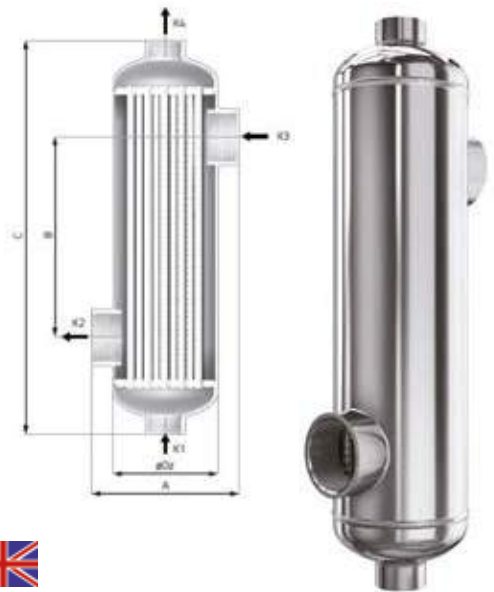

Descripción producto:

Intercambiadores de calor HEAT-SS fabricados en acero inoxidable calidad AISI-316L (EN 1.4404) que ofrecen una solución ideal para instalaciones con un gran caudal volumétrico como piscinas e hidromasajes y disponen de las siguientes características constructivas:

- Tubos interiores coarrugados de 8mm de diámetro que aumentan la superficie de intercambio de calor y reducen la deposición de impurezas.
- Totalmente soldados, sin riesgo de fugas.
- Baja pérdida de presión, no hay necesidad de instalar bypass (desviaciones).
- Resistentes a sustancias agresivas como flúor o cloro.
- Parámetros máximos de funcionamiento: 16 bar y 203°C.



Product descriptions:

Heat exchangers HEAT-SS made in stainless steel quality AISI-316L (EN 1.4404) that offer an ideal solution for installations with a large volumetric flow like swimming pools and hydromassages and have the following constructive characteristics:

- Coiled inner tubes 8mm in diameter that increase the heat exchange surface and reduce the deposition of impurities.
- Totally welded, with no risk of leakage.
- Low pressure loss, no need to install bypass.
- Resistant to aggressive substances such as fluorine or chlorine.
- Maximum operating parameters: 16 bar and 203°C.

Tipo Type	Superficie de intercambio de calor Heat exchange area	Capacidad lado tubo Tube side capacity	Capacidad lado carcasa Shell side capacity	Peso Weight	Dimensiones Dimensions			
					A	B	C	ØDz
	m ²	l	l	kg	mm	mm	mm	mm
B45	0,11	0,52	0,48	2,10	122,0	75,0	289,5	80,0
B70	0,18	0,64	0,84	3,00	122,0	175,0	389,5	80,0
B130	0,23	0,70	0,98	3,30	122,0	225,0	439,5	80,0
B180	0,38	1,21	1,38	4,60	143,6	193,0	379,0	101,6
B250	0,55	1,48	1,99	5,80	143,6	323,0	509,0	101,6
B300	0,73	1,76	2,58	7,30	143,6	451,0	637,0	101,6
B500	1,37	2,76	4,81	12,40	143,6	884,0	1103,0	101,6
B1000	1,97	4,55	7,78	23,50	190,0	598,0	943,0	139,7

HEAT-Ti



K1/K4:
inlet / outlet
heat source external
thread G1^{1/2}"

K3/K2:
inlet / outlet
pool water internal
thread G1^{1/2}"



Descripción producto:

Los intercambiadores de calor HEAT-Ti fabricados en titanio son la mejor elección para trabajar en las condiciones más exigentes, especialmente en piscinas con agua salada.

- Tubos interiores coarrugados de 8mm de diámetro que aumentan la superficie de intercambio de calor y reducen la depositación de impurezas.
- Totalmente soldados, sin riesgo de fugas.
- Baja pérdida de presión, no hay necesidad de instalar bypass (desviaciones).
- Resistentes a sustancias agresivas como flúor o cloro o agua salada.
- Parámetros máximos de funcionamiento: 16 bar y 150°C.



Product descriptions:

The HEAT-Ti heat exchangers made in titanium are the best option to work in the most extremely conditions, mainly with salt water.

- Coarrugated pipes inside of 8mm of diameter whhc increases the Exchange zone and reduces the fouling.
- Totally welded, without any leakage possibility.
- Low pression loss.
- Ressitant against very agressive products as salt water, fluor or chlorines.
- Max. Working parameters: 16 bar and 150°C.

Tipo Type	Superficie de intercambio de calor Heat exchange area		Capacidad lado tubo Tube side capacity		Capacidad lado carcasa Shell side capacity		Peso Weight		Dimensiones Dimensions							
	m ²	ft ²	l	gal	l	gal	kg	lb	A		B		C		ØDz	
	mm	in	mm	in	mm	in	mm	in	mm	in	mm	in	mm	in	mm	in
Ti250	0,34	3,7	0,94	0,2	1,19	0,3	2,2	4,9	140	5,5	170	6,7	357	14,1	101,6	4,0
Ti350	0,48	5,2	1,17	0,3	1,63	0,4	2,7	6,0	140	5,5	270	10,6	457	18,0	101,6	4,0
Ti500	0,69	7,4	1,51	0,4	2,34	0,6	3,8	8,3	140	5,5	420	16,5	607	23,9	101,6	4,0
Ti750	1,04	11,2	2,08	0,5	3,49	0,9	5,3	11,7	140	5,5	670	26,4	857	33,7	101,6	4,0
Ti1000	1,38	14,9	2,64	0,7	4,66	1,2	6,8	15,0	140	5,5	920	36,2	1107	43,6	101,6	4,0

VERTICALES Y CENTRIFUGAS

VERTICALES MULTICELULARES

64	V-NOX
65	[e] NOX
66	XV-F
70	XVN-F
72	VAT

CENTRIFUGAS HORIZONTALES

74	K
76	CB
77	KI
78	HK
79	CR CRB

NORMALIZADAS

80	AG
82	MN
85	NKM-G NKP-G
90	KDN

V-NOX



Aplicaciones:

Las bombas verticales multicelulares de la serie V-NOX, por su elevado rendimiento y funcionamiento EXTREMADAMENTE SILENCIOSO, son especialmente indicadas para su uso en equipos de presurización y equipos contra incendios.

Características constructivas:

Turbinas, eje bomba, cuerpo bomba en acero inoxidable ISO 431, difusores en tecnopolímero inyectado con fibra de vidrio, contrabridas de aspiración e impulsión, base aspiración y cuerpo de impulsión en fundición GG-20 con tratamiento de pintura epoxi-poliéster interior y exterior para ofrecer mas resistencia a la oxidación. Cierre mecánico en cerámica grafito y AISI 304.

Motor:

Motor asíncrono, cerrado de ventilación externa, apto para trabajo continuo. Grado de protección IP-55, aislamiento clase F (calentamiento "B") aptos para trabajo a través de variadores de frecuencia.

Temperatura máxima del agua: 45° C.

Temperatura máxima ambiente: 45° C.



Applications:

The multistage vertical pumps of the V-NOX series, through their high output and EXTREMELY SILENT operation, are particularly recommended for use in pressure and fire-fighting equipment both for civil and industrial use.

Constructive characteristics:

Impeller, pump shaft, pump housing in ISO 431 stainless steel, diffusers in technopolymer injected with glass fiber, suction and drive counter-flanges, suction base and drive housing in GG-20 cast iron with exterior and interior epoxi-poliéster treatment to prevent rust. Mechanical seal in graphite ceramic and AISI 304.

Motor:

Standard asynchronous motor, sealed from external ventilation, suitable for continuous work. IP-55 protection, class F isolation (heating "B") suitable for work through frequency inverters.

Maximum water temperature: 45° C.

Maximum ambient temperature: 45° C.

Tipo Type	Potencia		"A"			Con. µF	Caudal m³/h / Flow m³/h									Diámetro	
	HP	KW	II 230	III 230	III 400		1,5	3	4,5	6	7	8	9	10	11	ASP.	IMP.
							Altura m.c.a. / Height w.c.m.										
V-NOX 303 M/T	1,2	0,9	7,4	6,3	3,8	40	39	37	35	32	29	25	20	14	8	1 1/2"	1 1/4"
V-NOX 304 M/T	1,5	1,1	8,7	7,1	4,1	40	51	49	46	41	37	32	26	19	11	1 1/2"	1 1/4"
V-NOX 305 M/T	2	1,5	10,3	7,9	4,5	40	65	62	58	52	47	40	32	23	14	1 1/2"	1 1/4"
V-NOX 306 T	3	2,2	-	8,2	4,8	-	77	75	70	63	56	48	39	28	16	1 1/2"	1 1/4"
V-NOX 307 T	3	2,2	-	9,4	5,4	-	90	86	79	70	63	54	44	32	18	1 1/2"	1 1/4"
V-NOX 308 T	4	3	-	13,3	7,7	-	103	100	95	84	75	64	52	38	21	1 1/2"	1 1/4"
V-NOX 309 T	4	3	-	14,3	8,3	-	117	112	104	92	83	71	56	41	23	1 1/2"	1 1/4"
V-NOX 310 T	5,5	4	-	15,9	9,1	-	129	124	116	104	92	79	64	47	26	1 1/2"	1 1/4"

Tipo Type	Potencia		"A"			Con. µF	Caudal m³/h / Flow m³/h									Diámetro	
	HP	KW	II 230	III 230	III 400		1,5	3	4,5	6	9	12	15	18	21	ASP.	IMP.
							Altura m.c.a. / Height w.c.m.										
V-NOX 403 M/T	2	1,5	10,3	7,9	4,5	40	35	34,5	34	33	31	27	23	18	13	1 1/2"	1 1/4"
V-NOX 404 T	3	2,2	-	8,2	4,8	-	44	43	42	41	37	32,5	27	21	14	1 1/2"	1 1/4"
V-NOX 405 T	4	3	-	11,9	6,9	-	55	54	53	51,5	48	43	37	29,5	21	1 1/2"	1 1/4"
V-NOX 406 T	4	3	-	13,3	7,7	-	66	64,5	63	61	56	51	43	34	23	1 1/2"	1 1/4"
V-NOX 407 T	5,5	4	-	15,6	9	-	77	76	75	73	67	60	51	41	28	1 1/2"	1 1/4"

[e]NOX

con motor de imanes permanentes
with permanent magnet motor



Alta eficiencia
Ahorro energético
High efficiency
Energy saving



Características:

La nueva serie de bombas [e]NOX incorpora a las fantásticas capacidades hidráulicas de la serie V-NOX un nuevo **motor síncrono de imanes permanentes**, que junto al **variador de frecuencia** específicamente diseñado para este conjunto, nos proporciona una altísima eficiencia IE4 unido a un excepcional consumo eléctrico.

Las ventajas de trabajar con el binomio motor síncrono-variador de velocidad nos brinda un rendimiento hidráulico superior a la variante con motor asíncrono, una notable reducción de consumo eléctrico, un excelente rendimiento adaptándose la bomba a las necesidades de caudal instantáneo requerido por la instalación, una reducción importante de ruido y unos costes de mantenimiento prácticamente nulos, al funcionar la bomba en regímenes de velocidad variables.

Transductor de presión no incluido.



Characteristics:

The new series of pumps [e]NOX incorporates to the fantastic hydraulic capabilities of the V-NOX series, a new **permanent magnet synchronous motor**, which together with the **frequency driver** specifically designed for this set, provides us with a high efficiency IE4 united to an exceptional electrical consumption.

The advantages of working with the binomial synchronous motor- speed drive gives us a hydraulic performance superior to the variant with asynchronous motor, a remarkable reduction of electrical consumption, an excellent performance adapting the pump to the needs of instantaneous flow required by the installation, a significant reduction in noise and maintenance costs practically zero, because the pump operates at variable speeds.

Pressure transducer not included.



Eficiencia IE4
Reduce CO₂
Efficiency IE4
Reduces CO₂

Tipo Type	P1 (kW) max	P2		Caudal m ³ /h / Flow m ³ /h									ASP	IMP
		kW	HP	1,5	3	4,5	6	7	8	9	10	11		
Altura m.c.a. / Height w.c.m. (@ 2900 rpm)														
[e]nox 306 M	2,47	2,2	3	77	75	70	64	58	50	41	31	19	11/2"	11/4"
[e]nox 310 T	4,44	4	5,5	129	124	117	106	96	83	68	51	29	11/2"	11/4"

Tipo Type	P1 (kW) max	P2		Caudal m ³ /h / Flow m ³ /h									ASP	IMP
		kW	HP	1,5	3	4,5	6	9	12	15	18	21		
Altura m.c.a. / Height w.c.m. (@ 2900 rpm)														
[e]nox 407 T	4,44	4	5,5	77,5	76,5	75	73	68	62	54	44	32	11/2"	11/4"

XV-F

AISI 304



Aplicaciones:

Las electrobombas de la serie XV-F son bombas centrífugas verticales multicelulares, no autocebantes, con bocas de aspiración e impulsión en línea, que por su elevado rendimiento las hace ideales para su uso en equipos de presión, en instalaciones industriales y en todas aquellas aplicaciones en que se requiera altas presiones con caudales moderados.

Características Constructivas:

Turbinas, difusores, eje, camisa externa y cámaras intermedias, íntegramente en acero inoxidable AISI 304. Base aspiración-impulsión y cuerpo superior en fundición de hierro de alta resistencia. Sello mecánico en carburo de silicio/EPDM. Juntas tóricas en goma EPDM o teflón. **Incorporan un novedoso sello mecánico de tipo cartucho, que permite una fácil y rápida sustitución, sin desmontar ninguna pieza de la parte hidráulica de la bomba.**

Todas las versiones equipan bridas DIN y no incorporan contrabridas de serie:

XV-F 5	DN 32
XV-F 10	DN 40
XV-F 15 y XV-F 20	DN 50
XV-F 32	DN 65
XV-F 45	DN 80
XV-F 64 y XV-F 90	DN 100
XV-F 120 y XV-F 150	DN 125

Motor:

IE3 motor asíncrono, tipo cerrado y de ventilación externa, apto para trabajo continuo. Grado de protección IP-54, aislamiento clase F, a 2.850 r.p.m. Los modelos monofásicos a 230 V incorporan un protector térmico y condensador permanente.

Temperatura del líquido a bombear -15° C a +120° C
Temperatura máxima ambiente 50° C



Applications:

The electropumps of the XV-F series are multicellular vertical centrifugal pumps, non self-priming, with suction and drive in line, and their high output makes them ideal for use in pressure equipment, industrial installations and all applications requiring high pressures with moderate flows.

Constructive characteristics:

Impellers, diffusers, shaft, external cladding and intermediate chambers entirely in AISI 304 stainless steel. Suction drive base and upper body in high strength cast iron. Silicon carbide/EPDM mechanical seal. EPDM rubber or Teflon o-rings. **Includes a new mechanical seal type cartridge, for quick and easy substitution without dismantling any piece of the hydraulic part of the pump.**

All versions are fitted with DIN flanges and do not include counter flanges as standard.

XV-F 5	DN 32
XV-F 10	DN 40
XV-F 15 & XV-F 20	DN 50
XV-F 32	DN 65
XV-F 45	DN 80
XV-F 64 & XV-F 90	DN 100
XV-F 120 & XV-F 150	DN 125

Motor:

IE3 sealed asynchronous with external ventilation, suitable for continuous work. IP-55 protection, class F insulation, at 2,850 rpm. Single phase versions at 230 V includes a thermal protector and permanent capacitor.

Maximum water temperature -15° C to +120° C
Maximum ambient temperature 50° C

Tipo Type	Con. µF	Potencia		"A"			Caudal m³/h / Flow m³/h									Diámetro	
		HP	KW	II 230	III 230	III 400	0	1	2	3	4	5	6	7	8	ASP.	IMP.
							Altura m.c.a. / Height w.c.m.										
XV-F 5-8	25	1,5	1,1	9,3	4,2	2,4	52	51	48	46	43	39	34	28	22	DN 32	DN 32
XV-F 5-10	45	2	1,5	12	5,5	3,2	65	64	62	60	56	51	46	40	32	DN 32	DN 32
XV-F 5-14	-	3	2,2	-	7,6	4,4	93	92	90	87	82	75	67	58	47	DN 32	DN 32
XV-F 5-16	-	3	2,2	-	7,6	4,4	108	107	103	98	92	86	77	67	54	DN 32	DN 32
XV-F 5-20	-	4	3	-	10	5,8	135	133	131	126	118	110	98	85	68	DN 32	DN 32
XV-F 5-29	-	5,5	4	-	13,3	7,7	197	196	192	185	176	164	148	128	107	DN 32	DN 32
XV-F 5-36	-	7,5	5,5	-	17,5	10,1	246	242	236	227	216	200	182	158	132	DN 32	DN 32

Tipo Type	Potencia		"A"		Caudal m³/h / Flow m³/h									Diámetro	
	HP	KW	III 230	III 400	0	4,5	6	7	8	9	10	11	12	ASP.	IMP.
					Altura m.c.a. / Height w.c.m.										
XV-F 10-6	3	2,2	7,6	4,4	60	59	58	57	53	50	46	42	37	DN 40	DN 40
XV-F 10-9	4	3	10	5,8	90	88	87	85	80	76	70	64	57	DN 40	DN 40
XV-F 10-10	5,5	4	13,3	7,7	101	100	98	96	91	86	79	72	64	DN 40	DN 40
XV-F 10-12	5,5	4	13,3	7,7	121	120	117	114	108	102	95	86	77	DN 40	DN 40
XV-F 10-16	7,5	5,5	17,5	10,1	162	161	156	152	145	137	128	117	104	DN 40	DN 40
XV-F 10-22	10	7,5	23,7	13,7	225	223	218	211	202	190	178	162	145	DN 40	DN 40

Tipo Type	Potencia		"A"		Caudal m³/h / Flow m³/h									Diámetro	
	HP	KW	III 230	III 400	0	6	10	12	14	16	18	20	22	ASP.	IMP.
					Altura m.c.a. / Height w.c.m.										
XV-F 15-5	5,5	4	13,3	7,7	68	67	64	62	58	55	51	46	40	DN 50	DN 50
XV-F 15-7	7,5	5,5	17,5	10,1	97	95	90	87	82	78	72	66	59	DN 50	DN 50
XV-F 15-9	10	7,5	23,7	13,7	125	122	118	113	108	102	95	86	76	DN 50	DN 50
XV-F 15-14	15	11	33,6	19,4	194	190	183	178	170	160	149	135	120	DN 50	DN 50
XV-F 15-17	20	15	45,8	26,5	237	233	225	217	208	190	182	165	147	DN 50	DN 50

Tipo Type	Potencia		"A"		Caudal m³/h / Flow m³/h								Diámetro	
	HP	KW	III 400	III 690	0	4	8	12	16	20	24	28	ASP.	IMP.
					Altura m.c.a. / Height w.c.m.									
XV-F 20-5	7,5	5,5	10,1	5,8	70	70	69	67	63	58	50	37	DN 50	DN 50
XV-F 20-7	10	7,5	13,7	7,9	102	100	97	95	90	82	69	54	DN 50	DN 50
XV-F 20-10	15	11	19,4	11,2	145	144	142	139	130	118	103	80	DN 50	DN 50
XV-F 20-14	20	15	26,5	15,3	204	203	200	195	185	168	145	113	DN 50	DN 50
XV-F 20-17	25	18,5	32,5	18,8	250	247	245	238	226	207	179	140	DN 50	DN 50

XV-F AISI 304

Tipo Type	Potencia		"A"		Caudal m ³ /h / Flow m ³ /h								Diámetro	
	HP	KW	III 400	III 690	0	6	12	18	24	30	36	40	ASP.	IMP.
					Altura m.c.a. / Height w.c.m.									
XV-F 32-3	7,5	5,5	10,1	5,8	58	58	57	54	48	42	35	29	DN 65	DN 65
XV-F 32-4	10	7,5	13,7	7,9	76	76	75	72	65	58	48	39	DN 65	DN 65
XV-F 32-6	15	11	19,4	11,2	116	116	114	109	101	90	74	61	DN 65	DN 65
XV-F 32-8	20	15	26,5	15,3	154	156	152	146	136	120	100	82	DN 65	DN 65
XV-F 32-10	25	18,5	32,5	18,8	194	197	192	183	170	152	126	106	DN 65	DN 65
XV-F 32-12	30	22	38,5	22,3	232	237	232	222	205	185	152	127	DN 65	DN 65
XV-F 32-14	40	30	53	31	273	278	275	270	244	217	180	153	DN 65	DN 65

Tipo Type	Potencia		"A"		Caudal m ³ /h / Flow m ³ /h								Diámetro	
	HP	KW	III 400	III 690	0	10	18	26	34	42	50	58	ASP.	IMP.
					Altura m.c.a. / Height w.c.m.									
XV-F 45-2	10	7,5	13,7	7,9	50	50	49	47	45	40	34	29	DN 80	DN 80
XV-F 45-3	15	11	19,4	11,2	75	74	73	72	69	63	53	44	DN 80	DN 80
XV-F 45-4	20	15	26,5	15,3	100	101	100	97	92	84	71	57	DN 80	DN 80
XV-F 45-5	25	18,5	32,5	18,8	125	127	124	122	117	105	90	75	DN 80	DN 80
XV-F 45-6	30	22	38,5	22,3	151	152	151	149	139	128	110	90	DN 80	DN 80
XV-F 45-9-2	40	30	53	31	218	222	221	216	202	186	158	128	DN 80	DN 80
XV-F 45-10	50	37	64	37	252	255	253	249	232	218	185	153	DN 80	DN 80
XV-F 45-13-2	60	45	78	46	320	330	328	322	300	280	237	196	DN 80	DN 80

Tipo Type	Potencia		"A"		Caudal m ³ /h / Flow m ³ /h								Diámetro	
	HP	KW	III 400	III 690	0	12	24	36	48	60	72	85	ASP.	IMP.
					Altura m.c.a. / Height w.c.m.									
XV-F 64-2	15	11	19,4	11,2	60	58	56	53	49	45	40	33	DN 100	DN 100
XV-F 64-3-1	20	15	26,5	15,3	78	77	76	74	68	62	54	42	DN 100	DN 100
XV-F 64-4-2	25	18,5	32,5	18,8	98	98	97	94	86	78	68	52	DN 100	DN 100
XV-F 64-4	30	22	38,5	22,3	118	117	113	109	102	94	84	68	DN 100	DN 100
XV-F 64-6-2	40	30	53	31	156	155	154	149	140	128	114	89	DN 100	DN 100
XV-F 64-7-1	50	37	64	37	195	194	191	185	173	160	143	115	DN 100	DN 100
XV-F 64-8-1	60	45	78	46	223	226	223	217	204	187	167	135	DN 100	DN 100

XV-F AISI 304

Tipo Type	Potencia		"A"		Caudal m ³ /h / Flow m ³ /h								Diámetro	
	HP	KW	III 400	III 690	0	18	36	54	72	90	108	120	ASP.	IMP.
					Altura m.c.a. / Height w.c.m.									
XV-F 90-2-2	15	11	19,4	11,2	48	46	44	42	37	28	16	8	DN 100	DN 100
XV-F 90-2	20	15	26,5	15,3	68	64	59	54	48	42	32	24	DN 100	DN 100
XV-F 90-3-2	25	18,5	32,5	18,8	80	78	76	70	61	50	34	24	DN 100	DN 100
XV-F 90-3	30	22	38,5	22,3	102	96	89	82	74	64	50	40	DN 100	DN 100
XV-F 90-4	40	30	53	31	136	130	123	110	99	88	70	56	DN 100	DN 100
XV-F 90-5	50	37	64	37	170	162	152	140	127	110	88	72	DN 100	DN 100
XV-F 90-6	60	45	78	46	204	195	184	170	154	135	108	89	DN 100	DN 100

Tipo Type	Potencia		"A"		Caudal m ³ /h / Flow m ³ /h								Diámetro	
	HP	KW	III 400	III 690	0	22	44	66	88	110	132	160	ASP.	IMP.
					Altura m.c.a. / Height w.c.m.									
XV-F 120-1	15	11	19,4	11,2	29	28	26,5	25	23	20	16	10	DN 125	DN 125
XV-F 120-2-1	25	18,5	32,5	18,8	51	50	48	45	41	36	29	16	DN 125	DN 125
XV-F 120-2	30	22	38,5	22,3	59	58	56	53	49	44	37	26	DN 125	DN 125
XV-F 120-3	40	30	53	31	88	86	84	80	74	67	57	40	DN 125	DN 125
XV-F 120-4-1	50	37	64	37	110	108	105	99	92	83	70	47	DN 125	DN 125
XV-F 120-5-1	60	45	78	46	140	139	136	128	119	107	92	63	DN 125	DN 125
XV-F 120-6-1	75	55	95	55	170	168	163	155	143	130	112	78	DN 125	DN 125
XV-F 120-7	100	75	128	74	210	208	200	189	176	160	138	102	DN 125	DN 125

Tipo Type	Potencia		"A"		Caudal m ³ /h / Flow m ³ /h								Diámetro	
	HP	KW	III 400	III 690	0	25	50	75	100	125	150	180	ASP.	IMP.
					Altura m.c.a. / Height w.c.m.									
XV-F 150-1-1	15	11	19,4	11,2	22	21	19,5	18	16	14	11	6	DN 125	DN 125
XV-F 150-1	20	15	26,5	15,3	32	31	29,5	27	24	21	18	14	DN 125	DN 125
XV-F 150-2-1	30	22	38,5	22,3	54	52	50	47	43	38	32,5	25	DN 125	DN 125
XV-F 150-3-2	40	30	53	31	77	75	71	66	60	54	46	36	DN 125	DN 125
XV-F 150-3	50	37	64	37	97	95	90	84	77	68	60	50	DN 125	DN 125
XV-F 150-4-1	60	45	78	46	120	118	113	105	96	86	76	63	DN 125	DN 125
XV-F 150-5-2	75	55	95	55	140	138	132	124	115	105	92	75	DN 125	DN 125
XV-F 150-6	100	75	128	74	192	189	184	172	154	138	120	104	DN 125	DN 125

XVN-F

AISI-316



Aplicaciones:

Las electrobombas de la serie XVN-F son centrifugas verticales multicelulares con bocas de aspiración e impulsión en línea, que por su elevado rendimiento y los materiales que las componen las hace ideales para su uso en instalaciones industriales especiales para su uso en aguas químicamente agresivas como pueden ser sistemas de osmosis inversa, agua salada y agua con ácidos en disolución.

Características constructivas:

Turbinas, difusores, eje, camisa externa y cámaras inter-medias, base aspiración-impulsión, en acero inoxidable AISI 316. Cuerpo superior en fundición de alta resistencia no en contacto con el líquido.

Motor:

IE3 motor asíncrono, tipo cerrado y de ventilación externa, apto para trabajo continuo. Grado de protección IP-55, aislamiento clase F, a 2.850 r.p.m.

Temperatura del líquido a bombear . . . -15° C a +120° C
Temperatura máxima ambiente 40° C
Presión máxima de trabajo: 25 bar



Applications:

The electropumps of the XVN-F series are multicellular vertical centrifugal units with suction and drive in line, and their high output materials makes them ideal for use in pressure equipment, industrial installations that works with chemically aggressive waters like reverse osmosis, salt water and water with acids.

Construction:

Impellers, diffusers, shaft, external cladding and intermediate chambers, suction-drive base in AISI 316 stainless steel. Upper body in high strength cast iron not in contact with the pumped liquid.

Motor:

IE3 sealed asynchronous with external ventilation, suitable for continuous work. IP-55 protection, class F insulation, at 2,850 rpm.

Maximum water temperature -15° C to +120° C
Maximum ambient temperature 40° C
Maximum working pressure: 25 bar

Tipo Type	Potencia		A		Caudal m ³ /h / Flow m ³ /h						ASP	IMP
	HP	kW	III 230	III 400	0	0,7	1,2	1,6	2	2,4		
Altura m.c.a. / Height w.c.m.												
XVN-F 1-7	0,5	0,37	1,7	1	41	40	37	32	24	15	DN 25	DN 25
XVN-F 1-11	0,75	0,55	2,4	1,4	64	63	58,5	51	40	25,5		
XVN-F 1-15	1	0,75	3,3	1,9	87,5	85,5	81	71	57	36		
XVN-F 1-22	1,5	1,1	4,3	2,5	128	126	118	105	83	54		
XVN-F 1-30	2	1,5	5,9	3,4	175	172	161	145	118	77		
XVN-F 1-40	3	2,2	8,3	4,8	237	233	219	195	161	106		

Tipo Type	Potencia		A		Caudal m ³ /h / Flow m ³ /h						ASP	IMP
	HP	kW	III 230	III 400	0	1,6	2,4	3	3,6	4,4		
					Altura m.c.a. / Height w.c.m.							
XVN-F 3-6	0,75	0,55	2,4	1,4	45	42,5	39	35	30	19,5	DN 25	DN 25
XVN-F 3-8	1	0,75	3,3	1,9	60	58	53	47	40	26,5		
XVN-F 3-12	1,5	1,1	4,3	2,5	90	86	79	71	59	40,5		
XVN-F 3-16	2	1,5	5,9	3,4	120	116	107	96	81	54		
XVN-F 3-23	3	2,2	8,3	4,8	173	166	153	138	115	78		
XVN-F 3-31	4	3	10,9	6,6	235	224	207	187	159	106		

Tipo Type	Potencia		A		Caudal m ³ /h / Flow m ³ /h						ASP	IMP
	HP	kW	III 230	III 400	0	3	5	7	8	8,5		
					Altura m.c.a. / Height w.c.m.							
XVN-F 5-8	1,5	1,1	4,3	2,5	59	56	49	36	28	24	DN 32	DN 32
XVN-F 5-11	2	1,5	5,9	3,4	82	77	68	51	39	33		
XVN-F 5-16	3	2,2	8,3	4,8	119	112	99	74	58	50		
XVN-F 5-21	4	3	10,9	6,6	157	147	130	98	77	66		
XVN-F 5-28	5,5	4	13,8	8	210	197	174	132	105	90		
XVN-F 5-33	7,5	5,5	-	12,4	249	234	206	160	127	109		

Tipo Type	Potencia		A		Caudal m ³ /h / Flow m ³ /h						ASP	IMP
	HP	kW	III 230	III 400	0	6	8	10	12	14		
					Altura m.c.a. / Height w.c.m.							
XVN-F 10-6	3	2,2	8,3	4,8	67	62	58	52	44	34	DN 40	DN 40
XVN-F 10-8	4	3	10,9	6,6	90	84	79	71	60	46		
XVN-F 10-11	5,5	4	13,8	8,0	124	115	108	98	84	64		
XVN-F 10-15	7,5	5,5	-	12,4	171	159	149	134	114	88		
XVN-F 10-21	10	7,5	-	16,4	240	233	210	191	162	126		
XVN-F 10-22	15	11	-	23,5	250	235	221	201	171	132		

Tipo Type	Potencia		A		Caudal m ³ /h / Flow m ³ /h						ASP	IMP
	HP	kW	III 400	III 690	0	10	14	16	20	24		
					Altura m.c.a. / Height w.c.m.							
XVN-F 15-3	4	3	6,6	-	40	37	35,5	34	29	21	DN 50	DN 50
XVN-F 15-5	5,5	4	8	-	68	62	59	57	48	36		
XVN-F 15-7	7,5	5,5	12,4	7,2	96	88	83	79	68	51		
XVN-F 15-9	10	7,5	16,4	9,5	124	113	108	103	88	67		
XVN-F 15-14	15	11	23,5	13,6	194	177	168	160	136	106		
XVN-F 15-18	20	15	29	16,8	250	231	218	207	177	141		

VAT



VAT-127 L



VAT-163 L



VAT-205



Aplicaciones:

Bombas centrifugas multicelulares verticales, muy adecuadas para formar equipos con variador de frecuencia. Bombas silenciosas y de un gran rendimiento hidráulico.

BAJO DEMANDA SE PUEDEN FABRICAR CON ENTRADA Y SALIDA EN EL MISMO LADO.

Características Constructivas:

Series VAT 127 L y 163 L: cuerpo aspiración e impulsión en fundición GG-25. Camisa hidráulica, eje y tornillería en acero inoxidable, turbinas difusores y tapas difusor en Noryl inyectado de alta calidad con insertos en bronce para garantizar una elevada resistencia al desgaste. Cierre mecánico en cerámica carbón y de fácil acceso.

Series VAT 205: cuerpo aspiración e impulsión, soporte motor, acomplamiento y difusores en fundición gris, eje en acero inoxidable. Turbinas en noryl. Cierre mecánico de cerámica carbón y de fácil acceso.

Motor:

IE3 motor asíncrono standard, cerrado de ventilación externa, apto para trabajo continuo.

Grado de protección IP-55. Aislamiento clase F (calentamiento "B") tropicalizados a 2.850 r.p.m. 50 Hz y bajo demanda 60 Hz y otras tensiones.

Temperatura máxima del agua: 50° C
Temperatura máxima ambiente: 50° C



Applications:

Vertical multicellular centrifugal pumps. Like all the verticals, they are very suitable for use in pressure installations, or as a Jockey pump in fire-fighting units.

ON DEMAND, CAN BE MANUFACTURED WITH ENTRANCE AND EXIT ON THE SAME SIDE.

Constructive characteristics:

VAT 127 L and VAT 163 L SERIES: Suction and drive chambers, motor support and coupling in cast iron impellers and diffusers in GFN-2 injected Noryl, capped diffusers in brass, ambient diffuser cladding and shaft in stainless steel, easy access mechanical seal.

VAT 205 SERIES: Suction and drive chambers, motor support and coupling in cast iron. Impellers in bronze capped Noryl. Easy access mechanical seal.

Motor:

IE3 sealed asynchronous with external ventilation, IEC Standard, IP-55 protection.

Maximum water temperature: 50° C

Maximum ambient temperature: 50° C

Tipo "L" Type "L"	Potencia		"A"		Caudal m ³ /h / Flow m ³ /h											Diámetro		
	HP	KW	III 230	III 400	0	3	4	5	6	7	8	9	10	11	12	14	ASP.	IMP.
					Altura m.c.a. / Height w.c.m.													
VAT 127 L-6	3	2,2	8,1	4,7	61	59,5	58	56	54	50	46	40	35	28	21	13	1 1/2"	1 1/2"
VAT 127 L-7					71	70	68	66	63	59	54	47	40	33	25	14		
VAT 127 L-8					81	80	78	76	72	68	62	55	47	38	30	17		
VAT 127 L-9	4	3	10,8	6,2	91	89	88	85	82	76	70	61	52	43	33	19	1 1/2"	1 1/2"
VAT 127 L-10					101	99	97	95	91	85	78	69	59	49	38	22		
VAT 127 L-11	5,5	4	13,5	7,8	111	109	107	105	101	94	86	77	66	55	43	25	1 1/2"	1 1/2"
VAT 127 L-12					121	119	117	115	110	103	94	85	73	61	48	28		
VAT 127 L-13					131	129	127	125	120	112	102	93	80	67	53	30		

Tipo "L" Type "L"	Potencia		"A"		Caudal m ³ /h / Flow m ³ /h											Diámetro		
	HP	KW	III 230	III 400	0	6	8	10	12	14	16	18	20	22	24	26	ASP.	IMP.
					Altura m.c.a. / Height w.c.m.													
VAT 163 L-3	4	3	10,8	6,3	52	47	46,5	45	44	40	38	34	30	25	21	17	2'	2'
VAT 163 L-4	5,5	4	13,5	7,8	68	63	61	59	57	54	50	45	40	34	29	21	2'	2'
VAT 163 L-5*	7,5	5,5	-	11,8	85	77,5	76	74	72	70	66	60	54	45	38	28	2'	2'
VAT 163 L-6*					102	93	91	90	86	81	76	70	64	54	46	35		
VAT 163 L-7*	10	7,5	-	15,4	119	110	108	105	102	97	91	84	74	63	52	40	2'	2'
VAT 163 L-8*					136	123	119	116	112	107	103	96	85	76	64	51		
VAT 163 L-9*	12,5	9,3	-	18,5	154	141	138	134	127	123	118	110	95	88	76	63	2'	2'

* Voltaje de Serie 400/690 V (bajo demanda 230/400 V)

*Standard voltage 400/690 V (under demand 230/400 V)

Tipo Type	Potencia		"A"		Caudal m ³ /h / Flow m ³ /h											Diámetro		
	HP	KW	III 400	III 690	0	5	10	15	20	25	30	35	38	40	42	45	ASP.	IMP.
					Altura m.c.a. / Height w.c.m.													
VAT 205 - 3*	12,5	9,3	18,5	-	79	78	77	75	73	69	64	59	54	48	42	35	2 1/2"	2 1/2"
VAT 205 - 4*	20	15	29,4	-	105	104	103	100	97	92	85	79	71	69	56	47	2 1/2"	2 1/2"
VAT 205 - 5*	20	15	29,4	-	132	130	128	124,5	122	115	106	98	89	79	70	58	2 1/2"	2 1/2"
VAT 205 - 6*	25	18,5	34	-	158	156	154	149	146	138	127	116	106	95	84	70	2 1/2"	2 1/2"

* Voltaje de Serie 400/690 V (bajo demanda 230/400 V)

*Standard voltage 400/690 V (under demand 230/400 V)

K



Aplicaciones:

Bombas centrífugas adecuadas para pequeños trasiegos de líquidos, llenado de depósitos y otros usos generales. Las de 2 turbinas son las más adecuadas para su utilización para equipos de presión.

Características constructivas:

Cuerpo bomba y soporte en fundición con tratamiento anticorrosivo, incluso en superficie interna. Turbina en tecnopolímero o fundición de hierro, según modelo. Eje en acero inoxidable.

Motor:

IE3 asíncrono hermético de ventilación externa, protección termo-amperimétrica incorporada y condensador en versión monofásica.

TEMPERATURA DEL AGUA A BOMBEAR:

K-5/8/10/15/17/20/30/31/41 de -10° a + 50° C
 K-25/40/55/56/75/100/125/150 de -15° a + 110° C

MÁXIMA TEMPERATURA AMBIENTE: +40° C

MÁXIMA PRESIÓN DE TRABAJO:

K-5/8/10/15/20	6 kg./cm ²
K-17/25/31/41/56	8 kg./cm ²
K-30/40	10 kg./cm ²
K-55/75/100/125/150	12 kg./cm ²

TIPOS:

K-5/8/31/41/56	Monoturbina
K-15/20	2 Turbinas iguales
K-10/17/25/30/40/55/75/100/125/150	2 Turbinas contrapuestas



Applications:

Centrifugal pumps suitable for small transfer work with liquids, filling tanks and other general uses. The double impeller versions are the most suitable to be used as a pressuring system.

Constructional features:

Pump body and support in cast iron with rust-proof treatment, including the internal surface. Technopolymer or cast iron impeller, depending on the model. Shaft in stainless steel.

Motor:

IE3 sealed asynchronous motor with external ventilation, built-in thermal and amperimetric protection and capacitor in the single phase version.

TEMPERATURE OF THE WATER TO BE PUMPED:

K-5/8/10/15/17/20/30/31/41 from -10° to + 50° C
 K-25/40/55/56/75/100/125/150 from -15° to + 110° C

MAXIMUM AMBIENT TEMPERATURE: +40° C

MAXIMUM WORKING PRESSURE:

K-5/8/10/15/20	6 Kg./cm ²
K-17/25/31/41/56	8 Kg./cm ²
K-30/40	10 Kg./cm ²
K-55/75/100/125/150	12 Kg./cm ²

TYPES:

K-5/8/31/41/56	Single impeller
K-15/20	2 equal impellers
K-10/17/25/30/40/55/75/100/125/150	2 counter-posed impellers

Tipo Type	Potencia		"A"			Cond. μF	Caudal m ³ /h / Flow m ³ /h										Diámetro	
	HP	KW	II 230	III 230	III 400		1,2	2,4	3,6	4,8	6,0	7,2	8,4	9,6	10,8	ASP.	IMP.	
							Altura m.c.a. / Height w.c.m.											
K 5-M	0,5	0,37	3	-	-	10	22	19	17	14	7					1"	1"	
K 5-T			-	2,3	1,3	-												
K 8-M	1	0,75	6	-	-	20	30	27,5	23	19	16					1"	1"	
K 8-T			-	4,3	2,5	-												
K 10-M	1	0,75	5,5	-	-	20	42	41	36	27	14					1"	1"	
K 10-T			-	3,8	2,2	-												
K 15-M	1,5	1,1	7,1	-	-	25	39	38	36	34	32	28	24	18	14	1 1/2"	1"	
K 15-T			-	5,4	3,1	-												
K 17-M	1,5	1,1	8,3	-	-	31.5	52	47	42	34	24					1 1/4"	1"	
K 17-T			-	6	3,5	-												

Tipo Type	Potencia		"A"			Cond. μF	Caudal m ³ /h / Flow m ³ /h										Diámetro		
	HP	KW	II 230	III 230	III 400		1,2	3	4,5	6	7,5	9	10,5	12	18	24	27	ASP.	IMP.
							Altura m.c.a. / Height w.c.m.												
K 20-M	2,5	1,83	9	-	-	40	49	48	45	42	37	30	23					1 1/2"	1"
K 20-T			-	6,2	3,6	-													
K 25-M	2,5	1,83	12,8	-	-	40	60	55	47	35								1 1/4"	1"
K 25-T			-	8,4	4,8	-													
K 30-T	3	2,2	-	11,6	6,7	-	63	60	57	52	45	39						1 1/2"	1"
K 31-T	3	2,2	-	9	5,2	-	37	36	36	35	34	33	32	31	25			2"	1 1/4"
K 40-T	4	3	-	14,6	8,4	-	72	68	65	61	57	52						1 1/2"	1"
K 41-T	4	3	-	11,1	6,4	-	41	41	41	40	39	38	37	35	28			2"	1 1/4"
K 55-T	5,5	4	-	16,5	9,5	-	82	80	78	73	69	61	51					1 1/2"	1"
K 56-T	5,5	4	-	16,3	9,4	-		55	55	54	53	52	52	51	43			2"	1 1/4"
K 75-T*	7,5	5,5	-	-	12,9	-				73	72	71	70	69	58	43		2"	1 1/4"
K 100-T*	10	7,5	-	-	15	-				93	93	91	90	89	79	59		2"	1 1/4"
K 125-T*	12,5	9,2	-	-	18	-						84	83	82	74	65	55	2"	1 1/4"
K 150-T*	15	11	-	-	21	-						95	95	95	88	77	70	2"	1 1/4"

* Voltaje habitual 400/690. (Bajo demanda 230/400).

* Standard voltage 400/690. (Under demand 230/400).

CB



Aplicaciones:

Bombas centrífugas biturbina, especialmente aptas para su uso en equipos de presión.

Aspiración máxima 7 m.c.a., en caso de aspiraciones superiores a 4 m.c.a., instalar tubo de mayor diámetro al del orificio de aspiración.

Características constructivas:

Rodetes en latón, cuerpo bomba y soporte en fundición, eje en acero inoxidable.

Presión máxima admitida CB-100: 6 bar.

CB 160/210/310/400/600/750: 10 bar.

Temperatura máxima del agua: 90° C.

Motor:

Cerrado, autoventilado, grado de protección IP-44, aislamiento clase F, versiones monofásicas con protección térmica y condensador incorporados.



Applications:

Double impeller centrifugal pumps particularly suitable for use in pressure units.

Maximum suction 7 m.c.a. In the case of suctions of over 4 m.c.a., install a pipe with a wider diameter of the Suction hole .

Constructional features:

Brass impellers, pump body and support in cast iron, stainless steel shaft.

Maximum pressure admitted CB-100: 6 bar.

CB 160/210/310/400/600/750: 10 bar.

Maximum water temperature: 90° C.

Motor:

Sealed, self-ventilated, IP-44 protection, isolation class F, single phase versions with built-in thermal protection and capacitor.

Tipo Type	Potencia		"A"			Cond. µF	Caudal m³/h / Flow m³/h										Diámetro	
	HP	KW	II	III	III		0,9	1,8	2,7	3,6	4,8	6	7,2	11	13,8	ASP.	IMP.	
			230	230	400		Altura m.c.a. / Height w.c.m.											
CB 100 M	1	0,75	5,4	-	-	20	44	41	38	33	23					1"	1"	
CB 100 T			-	4,1	2,4													
CB 160 M	1,5	1,1	10,2	-	-	31,5	53	53	50	46	44	40				1 1/4"	1"	
CB 160 T			-	7	4,1													
CB 210 M	2,2	1,7	11,5	-	-	50	58	58	56	53	47	44	29			1 1/4"	1"	
CB 210 T			-	8,3	4,8													
CB 310 T	3	2,2	-	9	5,2	-	65	64	62	59	54	47	37			1 1/4"	1"	
CB 400 T	4	3	-	13,1	7,6	-	69	69	68	66	63	59	58	45		1 1/2"	1 1/4"	
CB 600 T	5,5	4	-	16,4	9,5	-	81	81	80	78	76	72	70	58		1 1/2"	1 1/4"	
CB 750 T	7,5	5,5	-	-	14,7	-	92	92	91	90	88	85	82	70	62	1 1/2"	1 1/4"	

KI



Aplicaciones:

Bomba centrífuga de la serie KI, **completamente en AISI-304** la hacen adecuada para aguas termales, lavado industrial, presurización civil e industrial (para líquido frío y caliente).

Características constructivas:

Cuerpo bomba y rodete en acero inoxidable AISI-304, soporte en aluminio y sello mecánico en cerámica-carbono* y NBR. Las bombas KI cumplen con los requisitos de eficiencia MEI.

**Bajo demanda, sello mecánico en vitón.*

Motor:

IE3 a 2.850 r.p.m., asíncrono estanco con aislamiento clase F = 155° C. y grado de protección IP-55.

Temperatura del líquido: -10°C a +90°C



Applications:

Single stage centrifugal pump made in **full AISI-304**, ready to work with thermal water, industrial cleaning, civil and industrial pressurization...

Constructional features:

Pump body and impeller in stainless steel AISI-304, motor support in aluminium and mechanical seal in ceramic-carbide* and NBR. The KI pumps comply the MEI efficiency regulation.

**Viton mechanical seal under demand.*

Motor:

IE3 at 2,850 r.p.m, asynchronous closed with isolation type F (155 ° C) and IP-55 protection.

Fluid temperature: -10°C to +90°C

Tipo Type	Potencia		"A"		Caudal m ³ /h / Flow m ³ /h										Diámetro	
	HP	KW	II	III	2	4	5	6	7	8	9	10	11	ASP.	IMP.	
			230	400	Altura m.c.a. / Height w.c.m.											
KI 12 M	1	0,75	6,5	-	28	26,5	24,5	23	21	18				1 1/4"	1"	
KI 16 M	1,3	1	7	-	30	28	26,5	25,5	24	22,5	21			1 1/4"	1"	
KI 16 T			-	2,9												
KI 22 M	2	1,5	9,7	-	38	36	34	33	32	30	28,5	26,5	25	1 1/4"	1"	

HK



Aplicaciones:

Bomba centrífuga monoturbina especialmente diseñada para suministro de agua primaria o circuitos de recirculación de agua caliente o aire acondicionado.

Características Constructivas:

Cuerpo de bomba, soporte y turbina en fundición, excepto Serie HK-10 (tecnopolímero) con tratamiento anticorrosivo incluso en su superficie interna, eje en acero inox. y selló en carbono cerámica.

Motor:

IE3 de tipo asíncrono, hermético y ventilación externa, protección de seguridad incorporada grado IP-44 y aislamiento tipo F, a partir de 7,5 CV voltaje habitual 400/690.

Temperatura del líquido a bombear:

-15° C a + 110° C (Serie HK-10: -10° C a + 50° C)

Máxima temperatura ambiente: 40° C

Presión máxima admitida:

- HK-10 / HK-25: 6 Kg./cm²
- HK-40 / HK-55: 8 Kg./cm²
- HK-75-100-101-102-125-126-150-151: 10 Kg./cm²



Applications:

A single impeller centrifugal pump especially designed for supplying primary water or hot water recirculation circuits or Air Conditioning.

Construction:

Pump body, support and impeller in cast iron, except for the HK-10 (Techno polymer) with rust-proof treatment, including the internal surface, stainless steel shaft, and ceramic carbon seal.

Motor:

IE3 sealed asynchronous motor with external ventilation, built-in IP-44 thermal protection and type F insulation. Standard voltage 400/690 volts from 7.5 HP.

Maximum water temperature:

From -15° to +110° C. (HK-10 From -10° to +50° C).

Maximum Ambient temperature: +40° C

Maximum Pressure admitted:

- HK-10 / HK-25: 6 Kg./cm²
- HK-40 / HK-55: 8 Kg./cm²
- HK-75-100-101-102-125-126-150-151: 10 Kg./cm²

Tipo Type	Potencia		"A"			Cond. µF	Caudal m ³ /h / Flow m ³ /h												Diámetro			
	HP	KW	II 230	III 230	III 400		6	9	12	18	24	30	36	42	48	60	72	90	ASP.IMP.			
																			Altura m.c.a. / Height w.c.m.			
HK-10-M	1	0,75	4,6	-	-	20	15	13	12	7									1 1/2"	1 1/2"		
HK-10-T			-	3,6	2,1	-																
HK-25-M	2,5	1,83	9,5	-	-	40			18	17	16	13	12							2"	2"	
HK-25-T			-	7,4	4,3	-																
HK40	4	3	-	10,2	5,9	-			29	27	25	19	13							2 1/2"	2"	
HK55	5,5	4	-	14,7	8,5	-			35	33	30	25	19	10						2 1/2"	2"	
HK75	7,5	5,5	-	-	11,5	-		50	49	45	37	24								65	50	
HK100	10	7,5	-	-	15	-		62	61	57	54	44	25							65	50	
HK101	10	7,5	-	-	14	-			44	43	42	41	38	35	31	23				80	65	
HK102	10	7,5	-	-	15,4	-				37	36	36	35	34	33	30	24	17		80	65	
HK125	12,5	9,2	-	-	18	-				51	50	48	47	44	41	31				80	65	
HK126			-	-	18	-			41	40	39	38	38	37	35	34	29	21			80	65
HK150	15	11	-	-	20,5	-				56	55	54	53	51	47	40	32			80	65	
HK151			-	-	19,3	-			45	44	44	43	42	42	41	38	35	28			80	65

CR



Aplicaciones:

Las electrobombas de la Serie CR son especialmente adecuadas para grandes trasvases, riegos por goteo, etc. a presiones relativamente bajas.

Serie CRB: electrobombas centrifugas construidas integramente en bronce marino especialmente adecuados para grandes trasvases de líquidos especialmente agresivos o bien agua de mar a presiones relativamente bajas.

Características constructivas:

Serie CR: cuerpo de bomba, soporte bomba motor y turbina en fundición de alta calidad con un pretratamiento de pintura epoxi-poliéster y secado al horno para darle más durabilidad y resistencia a la oxidación, sello mecánico en cerámica carbón y eje en acero inoxidable AISI-316.

Serie CRB: cuerpo bomba, soporte y turbina en bronce. Eje, tornillería y sello mecánico en acero inoxidable AISI 316. Partes de rozamiento del sello mecánico en carbón-cerámica.

Motor:

IE3 motor asíncrono normalizado, tipo cerrado y de ventilación externa, apto para trabajo continuo. Grado de protección IP-55, a 2.850 r.p.m. Aislamiento clase F.

Temperatura máxima del agua 95° C
Temperatura máxima ambiente 40° C
Presión máxima admitida 6 bar

CRB



Applications:

The electropumps of the CR Series are particularly suitable for large transfers, drip irrigation, etc. at relatively low pressures.

CRB Series: centrifugal electropumps built entirely in marine bronze, particularly suitable for large transfers of very aggressive liquids or sea water at relatively low pressures.

Constructional features:

CR Series: pump body, motor support and impeller in high strength cast iron with epoxy-polyester paint, mechanical seal in carbon ceramic and stainless steel shaft (aisi 316).

CRB Series: pump body, support and impeller in bronze. Shaft, bolts and mechanical seal in AISI 316 stainless steel. Contact parts of mechanical seal in carbon ceramic.

Motor:

IE3 sealed, asynchronous, with external ventilation, suitable for continuous work. IP-55 protection. All motors are standard at 2,850 r.p.m. Isolation class F.

Maximum water temperature 95° C
Maximum ambient temperature 40° C
Maximum pressure admitted 6 bar

Tipo Type	HP	KW	R.P.M	"A"		Altura m.c.a. / Height w.c.m.										Ø ASP.	Ø IMP.
						Caudal m ³ /h / Flow m ³ /h											
				230 V	400 V	6	8	10	12	14	16	18	20	22			
CR 300 / CRB 300	3	2,2	2.850	9	5,2	61	54	51	46	35	29					DN 80	DN 80
CR 400 / CRB 400	4	3	2.850	12	6,9	70	64	59	55	49	42	30				DN 80	DN 80
CR 550 / CRB 550	5,5	4	2.850	16,5	9,5	95	90	84	77	66	54	32				DN 125	DN 100
CR 551 / CRB 551	5,5	4	2.850	16,5	9,5	128	121	107	90	69	30					DN 125	DN 100
CR 750 / CRB 750	7,5	5,5	2.850	21,7	12,5	159	152	135	125	109	88	60				DN 125	DN 100
CR 1000 / CRB 1000	10	7,5	2.850	-	15,5	175	166	158	147	135	119	98	68			DN 125	DN 100
CR 1250 / CRB 1250	12,5	9,2	2.850	-	19	195	188	175	163	150	136	105	86			DN 125	DN 100
CR 1500 / CRB 1500	15	11	2.850	-	23	200	197	193	183	170	155	132	110	87		DN 125	DN 100

AG

autoaspirantes con rodete abierto
selfpriming with open impeller

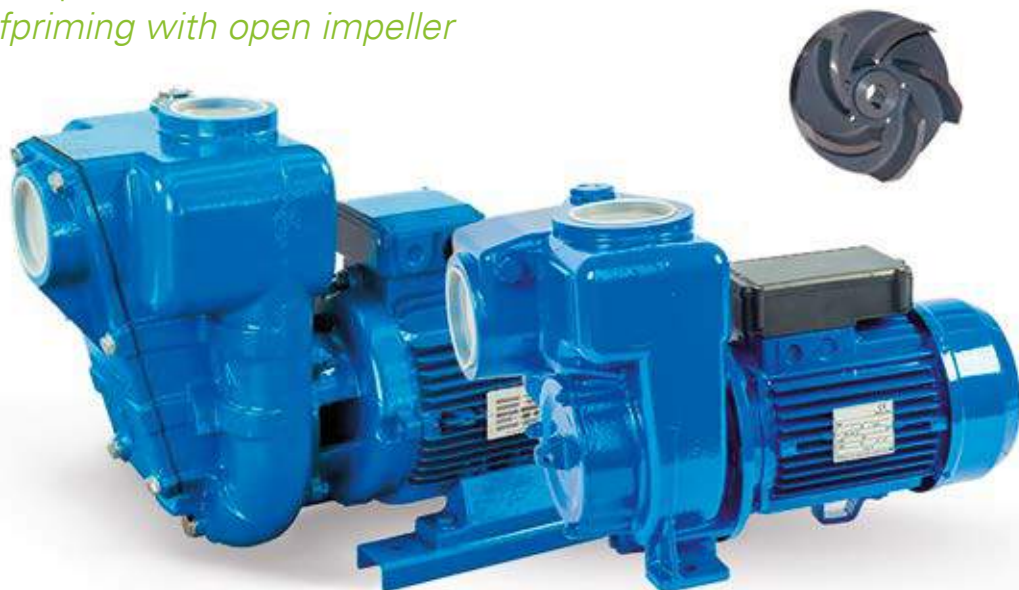

Aplicaciones:

Bombas de agua monobloc autocebantes con impulsor abierto. La válvula de retención dentro de la salida de succión evita el efecto sifón al detenerse y asegura su reinicio automático en cada arranque. Tiene la capacidad de cebarse automáticamente incluso si está parcialmente llena y con la tubería de aspiración completamente vacía. Adecuado para drenar agua limpia o ligeramente sucia y en sistemas de riego por inundación.

Características constructivas:

- Cuerpo bomba, soporte y turbina en fundición de hierro. Eje motor en acero inoxidable AISI-304. Sello mecánico en cerámica/grafito y NBR.
- Máxima temperatura del líquido: +90°C
- **Capacidad de succión: Hasta 7 metros**

Motor:

Motor asíncrono a 2900rpm, de ventilación externa apto para trabajo continuo. Protección IP-55. Aislamiento clase F.



Applications:

Self-priming monoblock water pumps with open impeller. The check valve inside the suction outlet avoids the syphon effect when stopping and assures the automatic re-start each time. The pump self-primers even if partially filled and if the suction hose is completely empty. Suitable to drain clean or slightly dirty water and in flood irrigation systems.

Constructive characteristics:

- Cast iron pump body, support and impeller. AISI-304 stainless steel motor shaft. Ceramic / graphite and NBR mechanical seal.
- Maximum liquid temperature: + 90°C
- **Suction capacity: Up to 7 meters**

Motor:

Asynchronous motor at 2900 rpm, with external ventilation suitable for continuous duty. IP-55 protection. Class F insulation.

Tipo Type	Potencia		"A"			Caudal m ³ /h / Flow m ³ /h								
	HP	kW	II 230V	III 230V	III 400V	3	6	12	18	24	30	36	48	60
						Altura m.c.a / Height w.c.m								
AG 50-1,1 M/T	1,5	1,1	8,2	6,4	3,7	18,5	18	16	13,5	10,5	6,5			
AG 50-1,5 M/T	2	1,5	9,5	7,8	4,5		18,5	17	15	12	9	4		
AG 80-2,2 T	3	2,2	-	9,9	5,7				15	14	13,5	13	11	6

Tipo Type	Potencia		"A"		Caudal m ³ /h / Flow m ³ /h								
	HP	kW	III 230V	III 400V	12	18	24	36	48	60	72	84	96
					Altura m.c.a / Height w.c.m								
AG 80-4 T	5,5	4	15,3	8,8	24	23	22	21	19	17	14	11	
AG 80-5,5 T	7,5	5,5	24,3	14		26,5	26	25	24	22,5	21	19	16,5

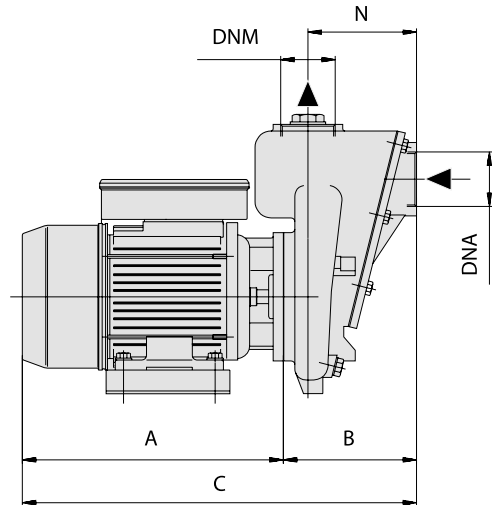
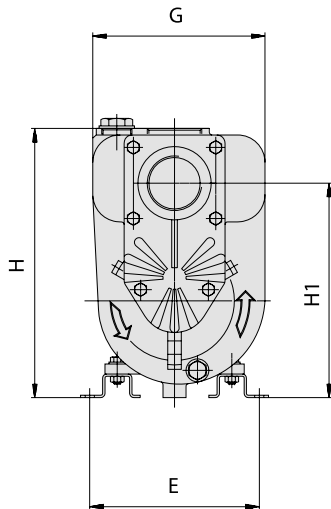

Tipo Type	DIMENSIONES mm / DIMENSIONS mm									
	A	B	C	E	G	H	H1	N	DNA	DNM
AG 50-1,1	260	152	412	185	193	302	240	122	2"	2"
AG 50-1,5	260	152	412	185	193	302	240	122	2"	2"
AG 80-2,2	335	193	598	200	193	312	220	150	3"	3"
AG 80-4	377	252	629	179	277	443	350	198	3"	3"
AG 80-5,5	424	252	676	216	277	443	350	198	3"	3"

PARA POTENCIAS SUPERIORES CONSULTE A NUESTRO DEPARTAMENTO COMERCIAL
FOR HIGHER POWERS CONSULT OUR COMMERCIAL DEPARTMENT

MN



Aplicaciones:

Electrobombas Centrifugas Normalizadas cuya construcción es según normas **DIN-24255 - NFE44-III-UNI 7467**.

- Estas bombas son aptas para el bombeo de agua limpia y otros líquidos químicamente no agresivos.
- Posibilidad de montaje en cualquier posición exceptuando la que requiere el orificio de aspiración hacia arriba.
- Bomba ideal para su uso en riegos, equipos de presión, instalaciones de climatización y otras instalaciones del sector civil, industrial o agrario.

Temperatura máxima del agua SERIE "MN" + 90° C

Temperatura máxima ambiente + 40° C

Presión máxima de trabajo 10 Bar

Características constructivas:

Cuerpo de bomba, soporte bomba motor y turbina en fundición de alta resistencia, orificios de aspiración e impulsión con bridas según normas **UNI 2236 PN 10**. Eje en acero inoxidable.

Motor:

Motor de inducción, tipo cerrado y autoventilado, apto para trabajo continuo. Grado de protección IP-55 y aislamiento clase F.

Los motores de la Serie "MN" son todos a 2.850 r.p.m.

A partir de 7,5 CV voltaje habitual 400/690 V (bajo demanda 230-400 V).



Applications:

Standardised Centrifugal Electropumps built as per **DIN - 24255 - NFE44-III-UNI 7467**.

- These pumps are suitable for pumping clean water and other liquids that are not chemically aggressive.
- They may be assembled in any position except for positions requiring the suction hole to point upwards.
- An ideal pump for use in sprinkling, pressure units, air conditioning units and other installations in the civil, industrial or agricultural sectors.

Maximum water temperature in the "MN" SERIES + 90° C

Maximum ambient temperature + 40° C

Maximum working pressure 10 Bar

Constructional features:

Pump body, pump motor support and impeller in high-strength cast iron inlet and outlet holes with flanges as per **UNI 2236 PN 10**. Stainless steel shaft.

Motor:

Induction motor, sealed and self-ventilated, suitable for continuous work. IP-55 protection and class F insulation.

The "MN" Series motors are all 2,850 rpm..

Standard voltage from 7.5 HP IS 400/690 V (230-400 V under demand).

Tipo Type	Potencia		"A"		Caudal m ³ /h / Flow m ³ /h										Diámetro		
	HP	KW	III 230	III 400	0	4,5	6	7,5	9	12	15	18	21	24	30	ASP.	IMP.
					Altura m.c.a. / Height w.c.m.												
MN 32-160 C	2	1,5	6,4	4	24,7	24,4	24,1	23,6	23	21,5	19,6	17,2	14,1			50	32
MN 32-160 B	3	2,2	8,5	5,2	29	29	28,5	28	27,3	25,7	23,8	21,4	18,5	14,8		50	32
MN 32-160 A	4	3	11,8	7,1	36,8	36,6	36,4	36	35,4	34,2	32,8	31,1	28,8	26	20	50	32
MN 32-200 C	5,5	4	16,2	9,4	40	39,7	39,6	39,5	39,1	38,5	37	35,2	33	30,6		50	32
MN 32-200 B	7,5	5,5	-	14,2	50	50	50	50	50	49	48	46,5	44,5	42,5	37	50	32
MN 32-200 A	10	7,5	-	16,5	59	59	59	59	59	58	57	56	53,5	50,5	46,2	50	32
MN 32-250 C	12,5	9,2	-	20,1	70	70	69	68,5	68	67	65,5	63,5	61,5	58,7	50,5	50	32
MN 32-250 B	15	11	-	24,2	82	82	81,5	81	80,5	79,5	78,5	77	75	72,6	66,5	50	32
MN 32-250 A	20	15	-	30,1	93	93	92,7	92,5	92	91,5	90,5	89,5	88	85,7	80	50	32

El modelo MN 32-160 C (2 HP) puede suministrarse en versión monofásica.
The model MN 32-160 C (2 HP) can be supplied with single phase motor.

Tipo Type	Potencia		"A"		Caudal m ³ /h / Flow m ³ /h									Diámetro			
	HP	KW	III 230	III 400	0	9	12	15	18	21	24	27	30	36	42	ASP.	IMP.
					Altura m.c.a. / Height w.c.m.												
MN 40-125 C	2	1,5	6,4	4	17,7	17,5	17,3	16,9	16,4	15,8	15,1	14,2	13,3			65	40
MN 40-125 B	3	2,2	8,5	5,2	21,5	21,3	21,2	21	20,6	20,1	19,4	18,7	17,9			65	40
MN 40-125 A	4	3	11,8	7,1	26	25,8	25,8	25,6	25,4	24,9	24,4	23,7	22,9	21,1		65	40
MN 40-160 B	4	3	13	7,4	30,3	30,1	30	29,6	29	28,2	27,1	25,9	24,4	21		65	40
MN 40-160 A	5,5	4	18	9,9	35,8	35,6	35,5	35,3	35	34,2	33,2	32	30,6	27,3		65	40
MN 40-200 B	7,5	5,5	-	13,2	47,5	47	46,8	46,4	45,6	44,5	43,2	41,6	39,9	35,8		65	40
MN 40-200 A	10	7,5	-	16,8	58	58	58	57,9	57,6	56,9	56	54,7	53	48,9	43,9	65	40
MN 40-250 B	15	11	-	24,2	75	74,6	74,2	73,5	72,7	71,7	70,4	69	67,2	62,5	56	65	40
MN 40-250 A	20	15	-	32	92	90,4	89,8	89,3	88,5	87,5	86,6	85,5	84	80,5	76	65	40

Tipo Type	Potencia		"A"		Caudal m ³ /h / Flow m ³ /h									Diámetro			
	HP	KW	III 400	III 690	0	24	27	30	36	42	48	54	60	66	72	ASP.	IMP.
					Altura m.c.a. / Height w.c.m.												
MN 50-125 B	4	3	7,4	-	19,9	19,8	19,3	19,1	18,3	17,4	16,4	15,3	14	12,7	11,2	65	50
MN 50-125 A	5,5	4	9,9	-	24,7	24,6	24,4	24,2	23,5	22,7	21,8	20,8	19,6	18,1	16,5	65	50
MN 50-160 B	7,5	5,5	11,6	6,7	30,4	30,3	30,1	29,8	29	28	26,7	25,1	23,3	21,3	19,1	65	50
MN 50-160 A	10	7,5	15,8	9	37	36,9	36,8	36,6	36,1	35,1	34	32,6	31	29,1	26,9	65	50
MN 50-200 C	12,5	9,2	18,5	10	47	45,7	45,1	44,5	42,9	40,2	38,5	35,9	33	29	24,5	65	50
MN 50-200 B	15	11	21	12	52	51	50,5	50	48,5	46,8	44,7	42,2	39,5	35,9	32	65	50
MN 50-200 A	20	15	27	16	58,5	58,1	58	57,5	56,4	55	53,2	51,3	49	46,3	42,8	65	50
MN 50-250 C	20	15	32,5	18	71,5	70,8	70,8	70,3	69	67,6	66	64	61,5	58,6	55	65	50
MN 50-250 B	25	18,5	41,5	24	78	78	78	77,4	76,1	74,5	72,8	70,6	68,2	65,5	62,2	65	50
MN 50-250 A	30	22,5	51,5	30	90	89,5	89,5	88,8	87,7	86,1	84,5	82,7	80,5	78	75,2	65	50

MN

Tipo Type	Potencia		"A"		Caudal m ³ /h / Flow m ³ /h											Diámetro	
	HP	KW	III 400	III 690	0	48	54	66	72	84	96	108	120	132	144	ASP.	IMP.
					Altura m.c.a. / Height w.c.m.												
MN 65-125 B	7,5	5,5	12,3	-	19,8	20,4	20,1	19,3	18,8	17,7	16,1	14,3	12,3			80	65
MN 65-125 A	10	7,5	15,9	-	24,2	24,3	24,1	23,7	23,4	22,3	20,9	19,4	17,5	15		80	65
MN 65-160 C	12,5	9,2	19,5	11	32	31,1	30,8	30,1	29,6	28,3	26,6	24,6	22,1	19,3	16	80	65
MN 65-160 B	15	11	22,5	13	35	34,4	34,2	33,7	33,3	32,1	30,6	28,8	26,7	24,1	21,1	80	65
MN 65-160 A	20	15	30	17	41	40,6	40,4	40	39,7	38,9	37,7	36,2	34,3	32,2	29,8	80	65
MN 65-200 C	20	15	32,5	18	45	44,8	44,8	44,1	43,7	42,3	40,5	38	35,3	32		80	65
MN 65-200 B	25	18,5	41,5	24	50	49,5	49,5	49	48,5	47,3	45,5	43,5	41	38		80	65
MN 65-200 A	30	22,5	51,5	30	57	56,7	56,7	56,2	55,7	54,7	53,3	51,6	49,6	47,1	44	80	65

Tipo Type	Potencia		"A"		Caudal m ³ /h / Flow m ³ /h										Diámetro		
	HP	KW	III 400	III 690	0	72	84	96	108	120	144	156	180	200	225	ASP.	IMP.
					Altura m.c.a. / Height w.c.m.												
MN 80-160 D	15	11	20,8	12	24	25,3	25,1	23,9	22,9	21,8	19,3	17,9	14,6			100	80
MN 80-160 C	20	15	25,8	15	29	29,6	29	28,1	27	25,9	23,4	22,0	18,7	16,4		100	80
MN 80-160 B	25	18,5	35	20	33,5	34,1	33,4	32,7	32	31	29	27,7	25	22,9		100	80
MN 80-160 A	30	22,5	42	25	37	37,2	37,3	36,9	36,2	35,5	33,5	32,4	29,9	28	22,9	100	80

NKM-G NKP-G



1.450 - 2.900 r.p.m.



Aplicaciones:

Bombas centrífugas Monobloc Normalizadas según Normativa DIN 24255 (DIN EN733 actual).

Con acoplamiento para equipar un motor totalmente Normalizado, ideales para una amplia gama de aplicaciones como puedan ser:

- Circulación de agua para circuitos de calefacción y refrigeración.
- Montajes en equipos de presión.
- Riegos.
- Otras instalaciones del sector civil, industrial o agrario.
- Pueden instalarse en posición horizontal o vertical pero con el motor siempre encima de la bomba.

Características constructivas:

Cuerpo bomba, soporte y turbina en fundición de hierro de alta resistencia.

Eje bomba que hace a su vez la función de acoplamiento en acero inoxidable AISI 304. Sello mecánico normalizado según DIN 24960 en carbón / carburo de silicio con juntas tóricas en EPDM.

Bajo demanda las turbinas pueden ser en Bronce.

Motor:

IE3 motor asíncrono, cerrado de ventilación externa de forma constructiva B3/B5. Aislamiento clase F, con grado de protección IP55 y tropicalizado. Todos los motores son multifrecuencia y multitensión.

A partir de 15CV (Mec 160) todos los motores incorporan de serie engrasador de cojinetes y sonda de temperatura. Los motores de esta serie pueden ser a 1.450 r.p.m. o 2.900 r.p.m..

Campo de temperatura de líquido bombeado: de -10° C a + 140° C.



Applications:

Enbloc, centrifugal motor-driven pumps with coupling designed for a wide range of applications such as:

- Supplying water.
- The circulation of hot water for the central heating.
- The circulation of cold water for air conditioning.
- The transfers of liquids in agriculture, industries.
- The implementation of pumping systems.

Constructional features:

Single-stage, cast iron spiral body made to DIN-EN 733 (formerly DIN 24255), cast iron support, flanges in accordance with DIN 2533 and DIN 2532 for DN 200. Impeller in cast iron, encased and dynamically balanced with compensation of the axial thrust by means of balancing holes, operating (on request) with interchangeable wear rings. AISI 304 stainless steel pump shaft. Standardised mechanical seal made to DIN 24960 in carbon/silicium carbide with O'rings in EPDM.

Motor:

IE3 closed, asynchronous motor with external ventilation, construction type B3/B5, 2 poles for NKP, and 4 poles for NKM. The rotor is mounted on extra large ball bearings to guarantee low noise running and durability. We recommend using overload protection for the motor, in accordance with current norms. In the case of liquids denser than water, the motors must be proportionally more powerful.

Water temperature: -10°C to +140°C

normalizadas monobloc 1.450 r.p.m. standardized monobloc 1.450 r.p.m.

MODELO <i>MODEL</i>	P2 NOMINAL		Q m³/h l/min	0	6	12	18	24	30	36	42	48	54	60	
	HP	KW		0	100	200	300	400	500	600	700	800	900	1000	
NKM-G 32-125.1 - 140 - 0.25 A A	0,33	0,25	H (m)	6,2	5,8	4,2									
NKM-G 32-125 - 142 - 0.37 A A	0,5	0,37		7	6,75	5,85	4,2								
NKM-G 32-160.1 - 169 - 0.37 A A	0,5	0,37		9,6	8,3	5,3									
NKM-G 32-160 - 169 - 0.55 A A	0,75	0,55		9,4	9	8,8	5,6								
NKM-G 32-200.1 - 200 - 0.55 A A	0,75	0,55		13,4	11,5	7,2									
NKM-G 32-200 - 200 - 0.75 A A	1	0,75		13	12,5	11,1	8,45								
NKM-G 32-200 - 219 - 1.1 A A	1,5	1,1		16	15,4	14,3	12,2								
NKM-G 40-125 - 115 - 0.25 A A	0,33	0,25		4,2	4,1	3,7	3	2,1							
NKM-G 40-125 - 130 - 0.37 A A	0,5	0,37		5,4	5,3	5	4,4	3,5							
NKM-G 40-125 - 142 - 0.55 A A	0,75	0,55		6,6	6,5	6,2	5,7	4,8							
NKM-G 40-160 - 153 - 0.55 A A	0,75	0,55		7,6	7,7	7,6	6,7	5,5							
NKM-G 40-160 - 166 - 0.75 A A	1	0,75		9,2	9,2	9	8,4	7,4	5,7						
NKM-G 40-200 - 200 - 1.1 A A	1,5	1,1		12,6	12,6	12,3	11,2	9,7	7,7						
NKM-G 40-200 - 219 - 1.5 A A	2	1,5		15,6	15,6	15,3	14,7	13,4	11,8	9,8					
NKM-G 40-250 - 245 - 2.2 A A	3	2,2		20,6	20,5	20,1	19,2	17,8	16						
NKM-G 40-250 - 260 - 3 A A	4	3		23,3	23,1	22,8	22,2	20,8	19						
NKM-G 50-125 - 130 - 0.55 A A	0,75	0,55		5,5		5,2	5	4,7	4,3	3,9	3,3	2,6			
NKM-G 50-125 - 141 - 0.75 A A	1	0,75		6,5		6,3	6,1	5,8	5,5	5	4,5	3,9			
NKM-G 50-160 - 161 - 1.1 A A	1,5	1,1		8,7		8,7	8,5	8,2	7,8	7,3	6,7	5,7			
NKM-G 50-160 - 177 - 1.5 A A	2	1,5		10,8		10,8	10,7	10,5	10,2	9,8	9,2	8,3			
NKM-G 50-200 - 210 - 2.2 A A	3	2,2		15,3		15,3	15,2	14,8	14	13,3	12,1	10,8	9,4		
NKM-G 50-200 - 219 - 3 A A	4	3		16,8		16,8	16,5	16,1	15,5	14,6	13,6	12,4	10,9		
NKM-G 50-250 - 263 - 4 A A	5,5	4		23,8		24	23,8	23,4	22,7	21,6	20,4	19	17,1		
NKM-G 65-125 - 130 - 0.75 A A	1	0,75		5,1		4,9	4,8	4,75	4,7	4,4	4,2	3,8	3,4	3	
NKM-G 65-125 - 144 - 1.1 A A	1,5	1,1		6,5		6,4	6,4	6,3	6,2	6	5,75	5,5	5,1	4,7	
NKM-G 65-160 - 153 - 1.1 A A	1,5	1,1		7,4		7,4	7,3	7,15	6,9	6,65	6,25	5,8	5,3	4,4	
NKM-G 65-160 - 165 - 1.5 A A	2	1,5		8,9			8,8	8,7	8,6	8,3	8	7,6	7,15	6,6	
NKM-G 65-160 - 177 - 2.2 A A	3	2,2		10,5				10,4	10,3	10,2	9,9	9,6	9,2	8,8	
NKM-G 65-200 - 210 - 3 A A	4	3		15,3				15,4	15,3	15	14,6	14,1	13,5	12,9	
NKM-G 65-200 - 219 - 4 A A	5,5	4		17				17,2	17,2	17,1	16,8	16,5	16,2	15,7	
NKM-G 65-250 - 263 - 5.5 A A	7,5	5,5		24,1				23,8	23,6	23,3	22,8	22,3	21,5	20,8	
NKM-G 65-315 - 279 - 7.5 A A	10	7,5		27							26	25,5	25	24,5	
NKM-G 65-315 - 309 - 11 A A	15	11		34,2							33,2	33	32,5	32	
NKM-G 80-160 - 153 - 1.5 A A	2	1,5		6,5					6,35	6,3	6,2	5,95	5,75	5,5	
NKM-G 80-160 - 163 - 2.2 A A	3	2,2		8,65					8,5	8,45	8,3	8,15	7,9	7,7	
NKM-G 80-160 - 177 - 3 A A	4	3		10,2					10,2	10,1	10	9,9	9,75	9,7	
NKM-G 80-200 - 200 - 4 A A	5,5	4		13,2							13,2	13,2	13,1	12,9	
NKM-G 80-200 - 222 - 5.5 A A	7,5	5,5		16,5							16,6	16,5	16,4	16,2	
NKM-G 80-250 - 240 - 7.5 A A	10	7,5		20,5							21	21	21	20,7	
NKM-G 80-250 - 270 - 11 A A	15	11		25,5							25,5	25,5	25,5	25,1	
NKM-G 80-315 - 305 - 15 A A	20	15		32,9										33,1	33
NKM-G 80-315 - 320 - 18.5 A A	25	18,5		36,8										37,1	37
NKM-G 80-315 - 334 - 22 A A	30	22		41										41,4	41,4
NKM-G 100-200 - 200 - 5.5 A A	7,5	5,5		12,7											12,6
NKM-G 100-200 - 214 - 7.5 A A	10	7,5		15,6											15,4
NKM-G 100-250 - 250 - 11 A A	15	11	21											21,5	
NKM-G 100-250 - 270 - 15 A A	20	15	25,5											25,5	
NKM-G 100-315 - 300 - 18.5 A A	25	18,5	32												
NKM-G 100-315 - 316 - 22 A A	30	22	36												
NKM-G 125-250 - 243 - 15 A A	20	15	19,5												
NKM-G 125-250 - 256 - 18.5 A A	25	18,5	22												
NKM-G 125-250 - 266 - 22 A A	30	22	24,6												
NKM-G 150-200 - 218 - 11 A A	15	11	13,2												

MODELO <i>MODEL</i>	P2 NOMINAL		Q m³/h l/min	0	6	12	18	24	30	36	42	48	54	60	
	HP	KW		0	100	200	300	400	500	600	700	800	900	1000	
NKP-G 32-125.1 - 102 - 0.75 A A	1	0,75	H (m)	13	12,5	11	8								
NKP-G 32-125.1 - 115 - 1.1 A A	1,5	1,1		17,2	17	15	12,5								
NKP-G 32-125.1 - 125 - 1.5 A A	2	1,5		21	20,8	19	16,8								
NKP-G 32-125.1 - 140 - 2.2 A A	3	2,2		27	26,9	25,9	23	19,5							
NKP-G 32-125 - 110 - 1.1 A A	1,5	1,1		15,8	15,4	14,5	12,9	9,9							
NKP-G 32-125 - 120 - 1.5 A A	2	1,5		19,4	19	18,2	16,8	14,5							
NKP-G 32-125 - 130 - 2.2 A A	3	2,2		23,7	23,4	23	21,8	19,8	16,8						
NKP-G 32-125 - 142 - 3 A A	4	3		28,6	28,2	27,6	26,5	24,6	21,8	17,9					
NKP-G 32-160.1 - 155 - 2.2 A A	3	2,2		32	31	27	22								
NKP-G 32-160.1 - 166 - 3 A A	4	3		38	36	33	28								
NKP-G 32-160 - 151 - 3 A A	4	3		30,5	30	29	27	24	19,5						
NKP-G 32-160 - 163 - 4 A A	5,5	4		36	36	35	33,5	30,5	27	22					
NKP-G 32-160 - 177 - 5.5 A A	7,5	5,5		43,5	43,2	42,6	41,5	39	36	31,5	25,5				
NKP-G 32-200.1 - 188 - 4 A A	5,5	4		51	48	44	37								
NKP-G 32-200.1 - 205 - 5.5 A A	7,5	5,5		57	56	52	46	35							
NKP-G 32-200 - 190 - 5.5 A A	7,5	5,5		47	46,5	45	43	40	35	29					
NKP-G 32-200 - 210 - 7.5 A A	10	7,5		58,5	58	57	56	53	49	44					
NKP-G 40-125 - 107 - 1.5 A A	2	1,5		14,7	14,5	14,3	13,8	13	11,8	10,5	8,6	7			
NKP-G 40-125 - 120 - 2.2 A A	3	2,2		19	18,7	18,4	17,8	17	15,9	14,6	13	11			
NKP-G 40-125 - 130 - 3 A A	4	3		22,8	22,5	22,3	22	21,2	20,2	19	17,4	15,5	13,5		
NKP-G 40-125 - 139 - 4 A A	5,5	4		26,4	26,2	26	25,6	25	24	23	21,5	19,5	17,5	15	
NKP-G 40-160 - 158 - 5.5 A A	7,5	5,5		34			34	33,5	32,5	31	29,5	27	24		
NKP-G 40-160 - 172 - 7.5 A A	10	7,5		41			41	41	40	39	37,5	35,5	33	30	
NKP-G 40-200 - 210 - 11 A A	15	11		57	57,5	58	58	57,5	57	55	53	50	47	43,5	
NKP-G 40-250 - 230 - 15 A A	20	15		72,5			72,5	72	70	68	66	62,5	60	56	
NKP-G 40-250 - 245 - 18.5 A A	25	18,5		83			83	82,5	81,5	80	77	74	71,5	67,5	
NKP-G 40-250 - 260 - 22 A A	30	22		96			96	94,5	93,5	92	90	87,5	84	81	
NKP-G 50-125 - 115 - 3 A A	4	3		17				16,5	16	15,5	15	14,5	13,7	13	
NKP-G 50-125 - 125 - 4 A A	5,5	4		20,5					20	19,5	19,1	18,5	18	17,5	16,5
NKP-G 50-125 - 135 - 5.5 A A	7,5	5,5		24					23,6	23,5	23,2	22,8	22,2	21,5	21
NKP-G 50-125 - 144 - 7.5 A A	10	7,5		28					27,8	27,5	27,3	27	26,5	25,8	25,5
NKP-G 50-160 - 153 - 7.5 A A	10	7,5		32					32,5	32,4	32	31,5	31	30,5	29,5
NKP-G 50-160 - 169 - 11 A A	15	11		39,5						40	39,8	39,5	39	38,5	38
NKP-G 50-200 - 200 - 15 A A	20	15		55						56	55,5	54	53,5	52	51
NKP-G 50-200 - 210 - 18.5 A A	25	18,5		61,5						62	62	61,5	60,5	59	58
NKP-G 50-200 - 219 - 22 A A	30	22		67,5						68	67,5	67	66	65,5	64
NKP-G 50-250 - 230 - 22 A A	30	22		73,5						75	74,5	73,8	73,5	71	68,5
NKP-G 50-250 - 257 - 30 A A	40	30		92,5						94	94	93,6	93,5	91	89
NKP-G 65-125 - 120/110 - 4 A A	5,5	4		16							15	14,6	14,2	13,7	13,3
NKP-G 65-125 - 127 - 5.5 A A	7,5	5,5		19,5							19	18,9	18,7	18,4	18,1
NKP-G 65-125 - 137 - 7.5 A A	10	7,5		23,5							23,1	23	22,8	22,6	22,5
NKP-G 65-160 - 157 - 11 A A	15	11		32,5									32,2	32	31,8
NKP-G 65-160 - 173 - 15 A A	20	15		40									40,2	40	39,8
NKP-G 65-200 - 190 - 18.5 A A	25	18,5		51,5									52	52	51,5
NKP-G 65-200 - 200 - 22 A A	30	22		56,5									58	58	57,5
NKP-G 65-200 - 219 - 30 A A	40	30	68,5									70	70	70	
NKP-G 80-160 - 147/127 - 11 A A	15	11	24												
NKP-G 80-160 - 153 - 15 A A	20	15	30,5												
NKP-G 80-160 - 163 - 18.5 A A	25	18,5	35,5												
NKP-G 80-160 - 169 - 22 A A	30	22	38,5												
NKP-G 80-200 - 190 - 30 A A	40	30	48												

KDN



Aplicaciones:

Bombas centrífugas a eje libre o sobre bancada normalizadas según Normativa DIN 24255 (DIN EN733 actual). Ideales para una amplia gama de aplicaciones como puedan ser:

- Circulación de agua para circuitos de calefacción y refrigeración.
- Montajes en equipos de presión.
- Riegos.
- Otras instalaciones del sector civil, industrial o agrario.
- Pueden ser acopladas con un acoplamiento elástico a un motor de 1.450 - 2.900 r.p.m. y montada sobre una bancada rígida.

Bajo demanda las turbinas pueden ser en bronce.

Características constructivas:

Cuerpo bomba, tapa porta sello mecánico, soporte en fundición de hierro. Turbina en fundición de hierro cerrada y equilibrada dinámicamente con compensación del esfuerzo axial. Eje bomba en Acero Inoxidable AISI 304 soportado por dos cojinetes de esferas ampliamente dimensionadas, engrasadas de por vida y alojadas en una cámara en el interior del soporte. Cierre mecánico normalizado según la DIN 24960 en carbón - carburo de silicio con juntas tóricas EPDM.

Motor:

IE3 motor asíncrono, cerrado de ventilación externa de forma constructiva B3. Aislamiento clase F, con grado de protección IP55 y tropicalizado. Todos los motores son multifrecuencia y multitensión. A partir de 15CV (Mec 160) todos los motores incorporan de serie engrasador de cojinetes y sonda de temperatura. Los motores de esta serie pueden ser a 1.450 r.p.m. o 2.900 r.p.m..

Campo de temperatura de líquido bombeado: de -10° C a + 140° C.



Aplicaciones:

Bare shaft, enbloc, centrifugal motor-driven pumps with coupling designed for a wide range of applications such as:

- *Supplyng water.*
- *The circulation of ot water for the central heating.*
- *The circulation of cold water for air conditioning.*
- *The transfers of liquids in agriculture, industries.*
- *Hydraulic pumps can be coupled by an elastic coupling to a motor at 1450rpm or a motor at 2900rpm and mounted on a rigid bench.*

Bronze impeller under demand.

Constructional features:

Single-stage, cast iron spiral body made to DIN-EN 733 (formely DIN 24255), cast iron support, flanges in accordance with DIN 2533 and DIN 2532 for DN 200. Impeller in cast iron, encased and dynamically balanced with compensation of the axial thrust by means of balancing holes, operating (on request) with interchangeable wear rings. AISI 304 stainless steel pump shaft. Standardised mechanical seal made to DIN 24960 in carbon/silicium carbide with O'rings in EPDM.

Motor:

IE3 closed, asynchronous motor with external ventilation, construction type B3 for 2 poles and 4 poles. The rotor is monted on extra large ball bearings to guarantee low noise running and durability. We recommend using overload protection for the motor, in accordance with current norms. In the case of liquids denser than water, the motors must be proportionally more powerfull. ip-55 protection insulation F.

Pumped liquid temperature range: -10° C to + 140° C.

KDN Normalizadas a 2.900 r.p.m. / Standardized to 2.900 r.p.m.

MODELO / MODEL	Q m ³ /h l/min	0	3	6	12	18	24	30	36	42	48	54	
		0	50	100	200	300	400	500	500	700	800	900	
KDN 32-125.1 / 105	H (m)	13,8 - 1,5		13,6 - 1,5	12,3 - 1,5	9,7 - 1,5				2.900 r.p.m. 			
KDN 32-125.1 / 110		15,5 - 1,5		15,2 - 1,5	13,9 - 2	11,5 - 2							
KDN 32-125.1 / 115		17,1 - 1,5		16,8 - 1,5	15,5 - 2	13,2 - 2							
KDN 32-125.1 / 120		18,8 - 2		18,5 - 2	17,3 - 2	15,1 - 3							
KDN 32-125.1 / 125		20,5 - 2		20,3 - 2	19,1 - 3	17 - 3							
KDN 32-125.1 / 130		22,3 - 2		22,1 - 2	21,3 - 3	19 - 3							
KDN 32-125.1 / 135		24,4 - 2		24,1 - 2	23,3 - 3	21,1 - 4	17,8 - 4						
KDN 32-125.1 / 140		26,5 - 2		26,4 - 2	25,6 - 3	23 - 4	20,1 - 5,5						
KDN 32-125 / 115		17,3 - 2			16,5 - 2	15,1 - 3	12,9 - 3						
KDN 32-125 / 120		19 - 2			18,2 - 2	17 - 3	14,9 - 3	11,1 - 3					
KDN 32-125 / 125		20,9 - 3			20,1 - 3	18,9 - 3	16,9 - 3	13,5 - 3					
KDN 32-125 / 130		22,9 - 3			22 - 3	21 - 3	19,1 - 4	16,2 - 4					
KDN 32-125 / 135		24,9 - 3			24 - 3	22,1 - 4	21,5 - 4	18,5 - 5,5	14,7 - 5,5				
KDN 32-125 / 142		27,8 - 4			27 - 4	26,1 - 4	24,5 - 5,5	21,7 - 5,5	18 - 5,5				
KDN 32-160.1 / 137		24 - 2		22 - 2	18,8 - 3								
KDN 32-160.1 / 145		27 - 2		25,5 - 2	22 - 3	15,5 - 3							
KDN 32-160.1 / 153		30 - 3		28,5 - 3	25,5 - 3	20 - 4							
KDN 32-160.1 / 161		33 - 3		31,6 - 3	29 - 4	24,5 - 5,5							
KDN 32-160.1 / 169		36,5 - 3		35 - 3	32,5 - 4	28,5 - 5,5	21,7 - 7,5						
KDN 32-160.1 / 177		40,5 - 4		39 - 4	36,5 - 5,5	33 - 5,5	26,2 - 7,5						
KDN 32-160 / 137	23,7 - 3			22,6 - 3	20,7 - 4	17,6 - 4							
KDN 32-160 / 145	27 - 4			25,8 - 4	23,9 - 4	21,2 - 5,5	16,9 - 5,5						
KDN 32-160 / 153	30,4 - 4			29,5 - 4	27,7 - 5,5	25,8 - 5,5	21,2 - 7,5						
KDN 32-160 / 161	34 - 5,5			33 - 5,5	31,7 - 5,5	29,1 - 7,5	25,5 - 7,5						
KDN 32-160 / 169	38 - 5,5			37,3 - 5,5	36 - 7,5	33,6 - 7,5	35,7 - 7,5	26,5 - 10					
KDN 32-160 / 177	41,8 - 5,5			41,5 - 5,5	40,5 - 7,5	38,4 - 7,5	35,3 - 10	31,4 - 10					
KDN 32-200.1 / 170	37 - 4		35,5 - 4	31 - 4	23 - 4								
KDN 32-200.1 / 180	41,9 - 4		40 - 4	36 - 5,5	28,8 - 5,5								
KDN 32-200.1 / 190	46,5 - 5,5		45 - 5,5	41 - 5,5	35,5 - 7,5								
KDN 32-200.1 / 200	51,8 - 5,5		50 - 5,5	46,5 - 7,5	40,5 - 7,5	31 - 7,5							
KDN 32-200.1 / 207	55,1 - 7,5		54 - 7,5	50,5 - 7,5	45 - 10	35 - 10							
KDN 32-200 / 170	34 - 5,5			33 - 5,5	31 - 5,5	27 - 7,5	21 - 7,5						
KDN 32-200 / 180	39 - 5,5			38,5 - 5,5	36,5 - 7,5	32,5 - 7,5	28 - 7,5						
KDN 32-200 / 190	45 - 7,5			43,5 - 7,5	42 - 7,5	39 - 7,5	34 - 10	28,5 - 10					
KDN 32-200 / 200	51 - 7,5			49 - 7,5	48 - 7,5	45 - 10	40,5 - 10	35 - 10					
KDN 32-200 / 210	57 - 7,5			56 - 7,5	55 - 10	52,5 - 10	48,5 - 15	43 - 15	36 - 15				
KDN 32-200 / 219	63 - 10			62 - 10	61 - 10	59 - 15	56,5 - 15	52,5 - 15	46,5 - 15	39,5 - 15			

N.º negro: **Altura m.c.a.** - N.º verde: **Potencia Nominal en CV** / N.º black: **Height w.c.m.** - N.º Green: **Nominal Power HP**

MODELO / MODEL	Q m³/h l/min	0	3	6	12	18	24	30	36	42	48	54	60
		0	50	100	200	300	400	500	600	700	800	900	1000
KDN 40-125 / 115	H (m)	16,8 - 3			13,3 - 3	15,6 - 3	15 - 3	14,3 - 4	13,2 - 4	12,6 - 4	9,8 - 4		
KDN 40-125 / 120		18,5 - 3			18 - 3	17,5 - 3	17 - 4	16 - 4	15 - 4	13,5 - 4	11,8 - 5,5		
KDN 40-125 / 125		20,4 - 4			20 - 4	19,5 - 4	19 - 4	18 - 4	16,7 - 5,5	15,3 - 5,5	13,5 - 5,5		
KDN 40-125 / 130		22 - 4			21,8 - 4	21,5 - 4	21 - 4	20 - 5,5	19 - 5,5	17,5 - 5,5	15,7 - 5,5	14 - 7,5	
KDN 40-125 / 135		24,1 - 4			24 - 4	23,9 - 4	23,4 - 5,5	22,5 - 5,5	21,5 - 7,5	20 - 7,5	18,3 - 7,5	16,4 - 7,5	
KDN 40-125 / 142		26,8 - 5,5			26,6 - 5,5	26,4 - 5,5	26 - 5,5	25,3 - 7,5	24,4 - 7,5	23 - 7,5	21,4 - 7,5	19,4 - 7,5	17 - 7,5
KDN 40-160 / 137		24 - 4				24 - 4	23 - 4	22 - 5,5	20,5 - 5,5	18 - 7,5	15 - 7,5		
KDN 40-160 / 145		27,5 - 5,5				27,5 - 5,5	27 - 5,5	25,9 - 5,5	24,2 - 7,5	22,1 - 7,5	19,5 - 7,5		
KDN 40-160 / 153		31 - 7,5				31 - 7,5	30,5 - 7,5	29,5 - 7,5	28 - 7,5	26,5 - 7,5	24 - 10	21 - 10	
KDN 40-160 / 161		34,5 - 7,5				35 - 7,5	34,5 - 7,5	33,9 - 7,5	32 - 10	30,5 - 10	28,5 - 10	25,8 - 10	22,5 - 10
KDN 40-160 / 169		38,5 - 7,5				39 - 7,5	38,5 - 7,5	38 - 10	37 - 10	35 - 10	33,5 - 15	31 - 15	28 - 15
KDN 40-160 / 177		42,5 - 10				43 - 10	42,5 - 10	42 - 10	41,5 - 15	40 - 15	38,5 - 15	35 - 15	33 - 15
KDN 40-200 / 170		33,5 - 7,5				34,5 - 7,5	33,5 - 7,5	32 - 7,5	30 - 7,5	28,5 - 10	22,5 - 10		
KDN 40-200 / 180		38,5 - 7,5				39,5 - 7,5	38,5 - 7,5	37 - 10	35 - 10	32,5 - 10	29 - 10	25 - 10	
KDN 40-200 / 190		43,5 - 10				44,5 - 10	44 - 10	43 - 10	41 - 10	38 - 15	35 - 15	31,5 - 15	27 - 15
KDN 40-200 / 200		48,5 - 10				50 - 10	49,5 - 10	48,5 - 15	46,5 - 15	44 - 15	41,5 - 15	38,5 - 15	34,5 - 15
KDN 40-200 / 210		54 - 15				55,5 - 15	55,5 - 15	54,5 - 15	53 - 15	51 - 15	48,5 - 15	46 - 20	42,5 - 20
KDN 40-200 / 219		60 - 15				61 - 15	61 - 15	60,5 - 15	59 - 15	57 - 20	55 - 20	62,5 - 20	49,5 - 20
KDN 40-250 / 220		63 - 15				63 - 15	62,5 - 15	61 - 15	59 - 15	57 - 20	55 - 20	52 - 20	48 - 20
KDN 40-250 / 230		69,5 - 15				69,5 - 15	68,5 - 15	68 - 15	66 - 20	63,5 - 20	61 - 25	58 - 25	55 - 25
KDN 40-250 / 240		76 - 20				76 - 20	76 - 20	75 - 20	73 - 20	70,5 - 25	68 - 25	65 - 25	62 - 30
KDN 40-250 / 250		83 - 20				83 - 20	82,5 - 20	81,5 - 20	80 - 25	78 - 25	75,5 - 30	72,5 - 30	69 - 30
KDN 40-250 / 260		91 - 25				90,5 - 25	90 - 25	89,5 - 25	88,5 - 25	86,5 - 30	84 - 30	81 - 30	78 - 40
KDN 50-125 / 115		16,8 - 4						16 - 4	15,5 - 4	15 - 4	14,3 - 5,5	13,6 - 5,5	13 - 5,5
KDN 50-125 / 120		18,1 - 5,5						17,5 - 5,5	17 - 5,5	16,5 - 5,5	16 - 5,5	15,3 - 7,5	14,7 - 7,5
KDN 50-125 / 125		19,8 - 5,5						19,4 - 5,5	19 - 5,5	18,5 - 5,5	17,9 - 5,5	17,4 - 7,5	16,6 - 7,5
KDN 50-125 / 130		21,5 - 7,5						21,1 - 7,5	20,8 - 7,5	20,5 - 7,5	19,8 - 7,5	19,2 - 7,5	18,5 - 7,5
KDN 50-125 / 135		23,2 - 7,5						23 - 7,5	22,6 - 7,5	22,3 - 7,5	21,8 - 7,5	21,2 - 10	20,6 - 10
KDN 50-125 / 139		24,7 - 7,5						24,5 - 7,5	24,3 - 7,5	24 - 7,5	23,5 - 7,5	23 - 10	22,4 - 10
KDN 50-125 / 144		25,9 - 10						26,5 - 10	26,4 - 10	26,1 - 10	25,6 - 10	25,1 - 10	24,5 - 10
KDN 50-160 / 137		24 - 7,5						24 - 7,5	24 - 7,5	23,5 - 7,5	23 - 7,5	22,5 - 7,5	21 - 7,5
KDN 50-160 / 145		27,5 - 7,5						27,5 - 7,5	27,5 - 7,5	27 - 7,5	26 - 7,5	25,5 - 7,5	25 - 10
KDN 50-160 / 153		30,5 - 10						31 - 10	31 - 10	30,5 - 10	30 - 10	29,5 - 10	28,5 - 10
KDN 50-160 / 161		32 - 10						34,5 - 10	34,5 - 10	34 - 10	33,5 - 15	33,5 - 15	32,5 - 15
KDN 50-160 / 169		37,5 - 15						38,5 - 15	38,5 - 15	38 - 15	37,5 - 15	37,5 - 15	36,5 - 15
KDN 50-160 / 177		41,5 - 15						42,5 - 15	42,5 - 15	42 - 15	42,8 - 15	41,5 - 15	41 - 15
KDN 50-200 / 170		38 - 10						38 - 10	37,5 - 10	37 - 10	35 - 10	34 - 15	32 - 15
KDN 50-200 / 180		42,5 - 10						43 - 10	42,5 - 10	41,5 - 15	40,5 - 15	39,5 - 15	38 - 15
KDN 50-200 / 190		47 - 15						48 - 15	47,5 - 15	47 - 15	46 - 15	44,5 - 15	43,5 - 15
KDN 50-200 / 200		52,5 - 15						53,5 - 15	53 - 15	52,5 - 15	51,5 - 15	50,5 - 20	49 - 20
KDN 50-200 / 210	58,5 - 15						59 - 15	59 - 15	58,5 - 15	57,5 - 20	56,5 - 20	55,5 - 20	
KDN 50-200 / 219	64 - 20						65 - 20	64,5 - 20	64 - 20	63,5 - 20	62,5 - 20	61,5 - 25	
KDN 50-250 / 220	64 - 20						65 - 20	64,5 - 20	63 - 20	62 - 20	61 - 20	59 - 25	
KDN 50-250 / 230	69 - 20						72 - 20	71 - 20	70 - 20	69 - 25	68 - 25	66 - 25	
KDN 50-250 / 240	76 - 25						78 - 25	78 - 25	77 - 25	76 - 25	74,5 - 30	73 - 30	
KDN 50-250 / 250	84 - 25						85,5 - 25	85 - 25	84,5 - 25	83,5 - 30	84 - 40	80,5 - 40	
KDN 50-250 / 263	92 - 30						94 - 30	94 - 30	93,5 - 30	92,5 - 30	91,5 - 40	90 - 40	

KDN

Tablas de selección rápida / Numerical selection table

66	72	78	84	90	102	114	120	150	180	210	240	270	300	330	360	390	420
1100	1200	1300	1400	1500	1700	1900	2000	2500	3000	3500	4000	4500	5000	5500	6000	6500	7000

2.900 r.p.m.



30 - 15

38 - 20

46 - 20 40 - 20

51 - 25

58,5 - 30

66 - 30

74 - 40

12,2 - 5,5 11,5 - 5,5 10,4 - 5,5 9 - 5,5

14 - 7,5 13,2 - 7,5 12 - 7,5 11,2 - 7,5 10 - 7,5

16 - 7,5 15,1 - 7,5 14 - 7,5 13 - 7,5 11,8 - 10

17,8 - 7,5 17 - 10 16,5 - 10 15,2 - 10 14 - 10

19,9 - 10 19,3 - 10 18,4 - 10 17,5 - 10 16,3 - 10 13,7 - 10

21,6 - 10 20,8 - 10 20 - 10 19,2 - 10 18 - 10 15,5 - 15

24 - 10 23,2 - 10 22,3 - 15 21,5 - 15 20,5 - 15 17,8 - 15 15 - 15

20,3 - 10 19 - 10 18 - 10 16,8 - 10 15 - 10

23,8 - 10 23 - 10 21,5 - 10 20,5 - 15 19 - 15

27,7 - 15 26,5 - 15 25,5 - 15 24,5 - 15 23 - 15

31,8 - 15 31 - 15 29,8 - 15 28,5 - 15 27,5 - 15

36 - 15 35,5 - 15 34,2 - 15 33 - 20 31,5 - 20 29 - 20

40,5 - 20 39,5 - 20 38,8 - 20 38 - 20 36,7 - 20 33,5 - 20

30 - 15 27 - 15 25 - 15

36 - 15 34 - 15 32 - 20 29 - 20

42 - 20 40 - 20 38 - 20 35,5 - 20 33 - 20

47,5 - 20 46 - 20 44,5 - 25 42 - 25 40 - 25

54 - 25 52,5 - 25 51 - 25 49 - 25 46,5 - 30 41,5 - 30

60 - 25 58,5 - 25 57 - 30 55 - 30 53 - 30 48,5 - 40

57,5 - 25 55 - 25 53 - 25 50 - 30 46,5 - 30 36 - 30

64 - 30 62 - 30 60 - 30 57 - 30 54 - 40 45 - 40

71,5 - 30 69 - 40 67 - 40 65 - 40 62 - 40 55 - 40

78,5 - 40 77 - 40 75 - 40 72,5 - 40 70 - 40 64 - 50

88,5 - 40 86,5 - 40 84,5 - 50 82,5 - 50 82 - 50 75 - 50 61 - 50

MODELO / MODEL	Q m ³ /h l/min	0	3	6	12	18	24	30	36	42	48	54	60		
		0	50	100	200	300	400	500	600	700	800	900	1000		
KDN 65-125 / 120 / 110	H (m)	16 - 7,5									14,4 - 7,5	14 - 7,5	13,6 - 7,5		
KDN 65-125 / 120		17,8 - 7,5										16 - 7,5	15,6 - 7,5	15,3 - 7,5	
KDN 65-125 / 125		19,4 - 7,5										17,8 - 7,5	17,5 - 7,5	17,1 - 7,5	
KDN 65-125 / 130		21 - 7,5										19,6 - 7,5	19,5 - 7,5	19,1 - 7,5	
KDN 65-125 / 135		22,6 - 10										21,8 - 10	21,5 - 10	21,3 - 10	
KDN 65-125 / 140		24 - 10										23,6 - 10	23,5 - 10	23,4 - 10	
KDN 65-125 / 144		25,6 - 15										25,6 - 15	25,5 - 15	25,3 - 15	
KDN 65-160 / 137		23 - 10										22,7 - 10	22,5 - 10	22 - 10	
KDN 65-160 / 145		26 - 10										26 - 10	25,5 - 10	25 - 10	
KDN 65-160 / 153		29 - 15										29,5 - 15	29 - 15	28,7 - 15	
KDN 65-160 / 161		32,5 - 15										33 - 15	32,7 - 15	32,5 - 15	
KDN 65-160 / 169		36,5 - 15										36,6 - 15	36,5 - 15	36,4 - 15	
KDN 65-160 / 177		40 - 20										40,5 - 20	40,5 - 20	40,3 - 20	
KDN 65-200 / 170		37 - 15										38,5 - 15	38 - 15	37,5 - 15	
KDN 65-200 / 180		42 - 15										43 - 15	43 - 15	42,5 - 15	
KDN 65-200 / 190		48 - 20										49,5 - 20	49 - 20	48,5 - 20	
KDN 65-200 / 200		53 - 20										54,5 - 20	54,5 - 20	54,5 - 20	
KDN 65-200 / 210		59 - 25										60,5 - 25	60,5 - 25	60 - 25	
KDN 65-200 / 219		65 - 25										66,5 - 25	66,5 - 25	66 - 25	
KDN 65-250 / 220		63 - 25										63 - 25	62,5 - 25	62 - 25	
KDN 65-250 / 230		69,5 - 30										69,5 - 30	69 - 30	68,5 - 30	
KDN 65-250 / 240		76 - 40										76 - 40	75,5 - 40	75 - 40	
KDN 65-250 / 250		83 - 40										83 - 40	82,5 - 40	82,5 - 40	
KDN 65-250 / 263		93 - 40										92,5 - 40	92 - 40	92 - 40	
KDN 65-315 / 260		94 - 30													
KDN 65-315 / 275		105 - 30													
KDN 65-315 / 290		117 - 30													
KDN 65-315 / 305		129 - 40													
KDN 65-315 / 320		143 - 50													
KDN 80-160 / 147 / 127		23 - 15													
KDN 80-160 / 153 / 136		25,5 - 15													
KDN 80-160 / 153		29,2 - 20													
KDN 80-160 / 161		32,8 - 20													
KDN 80-160 / 169		36,5 - 25													
KDN 80-160 / 177		40 - 25													
KDN 80-200 / 170		36,5 - 25													
KDN 80-200 / 180		41 - 25													
KDN 80-200 / 190		45,5 - 30													
KDN 80-200 / 200		51 - 40													
KDN 80-200 / 210		56 - 40													
KDN 80-200 / 222		63,5 - 50													
KDN 80-250 / 220		62 - 50													
KDN 80-250 / 230		68 - 50													
KDN 80-250 / 240		75,5 - 60													
KDN 80-250 / 250		82,5 - 60													
KDN 80-250 / 260		90 - 75													
KDN 80-250 / 270		98 - 75													
KDN 80-315 / 275		104 - 40													
KDN 80-315 / 290		116 - 40													
KDN 80-315 / 305		124 - 50													
KDN 80-315 / 320	141 - 60														
KDN 80-315 / 334	153 - 75														

KDN

Tablas de selección rápida / Numerical selection table

66	72	78	84	90	102	114	120	150	180	210	240	270	300	330	360	390	420
1100	1200	1300	1400	1500	1700	1900	2000	2500	3000	3500	4000	4500	5000	5500	6000	6500	7000
13,1-7,5	12,8-7,5	12,2-7,5	11,9-7,5	11,4-7,5	10,2-7,5	8,7-7,5	8-7,5										
14,9-7,5	14,4-7,5	13,9-7,5	13,4-7,5	13-7,5	11,5-10	10,3-10	9,4-10										
16,8-7,5	16,4-7,5	16-7,5	15,4-10	15-10	13,5-10	12,2-10	11,4-10										
18,9-10	18,5-10	18-10	17,5-10	17-10	15,7-10	14,2-10	13,2-15										
21-10	20,5-10	20,1-10	19,6-10	19,2-10	18-15	16,5-15	15,6-15										
23-10	22,8-10	22,3-15	22-15	21,4-15	20,3-15	18,9-15	18-15	13,8-15									
25-15	24,6-15	24,3-15	24-15	23,4-15	22,5-15	21,1-15	22,2-15	16-15									
21,3-10	20,5-10	19,7-10	19-10	18-10	16-10												
24,6-10	24-10	23,5-15	22,7-15	22-15	20-15	17,8-15	16,5-15										
28,5-15	28-15	27,5-15	26,6-15	26-15	24-15	22-15	21-15										
32-15	31,7-15	31,3-15	30,5-15	30-15	28,5-20	26,5-20	25,5-20										
36-15	35,7-15	35,3-20	34,7-20	34-20	32,7-20	31-20	30-20										
40-20	39,8-20	39,5-20	39-20	38,5-20	37,2-20	35,5-25	34,7-25	28,5-25									
36,5-15	36-15	35-15	34-15	32,5-15	30-20	27-20	25-20										
42-15	41,5-15	41-20	40-20	39-20	36,5-20	34-25	32-25										
48-20	47,5-20	47-20	46-20	45-25	43-25	40,5-25	39-30										
54-20	53,5-25	53-25	52,5-25	52-25	50-30	48-30	46,5-30										
60-25	59,5-25	59-30	58,5-30	58-30	56,5-40	54,5-40	53,5-40										
66-30	65,5-30	65-30	65-40	64,5-40	63-40	61-40	60-40	52,5-50									
61-30	60-30	59,5-30	58-30	57-30	54-40	50,5-40	48-40										
68-30	67-40	66-40	65-40	64-40	63-40	58,5-40	56,5-50										
75-40	74-40	73-40	72-40	71-40	69-50	66-50	64-50										
82-40	81,5-40	81-40	80-50	79-50	76,5-50	73,5-50	72-60	60-60									
91,5-50	91,5-50	91-50	90-50	89,5-50	87,5-60	85-60	83-60	72,5-75									
	92-40	91-50	90-50	88-50	87-50	83-60	80-60	66-60									
	104-50	103-50	102-50	101-60	99-60	96-60	95-60	83-75									
	115-60	115-60	114,5-60	114-60	112-60	109,5-75	109-75	99,5-100	86-100								
	128-75	128-75	127,5-75	127-75	126-100	124-100	123-100	116-100	103,5-125	88-125							
	141-75	141-100	140,5-100	140-100	139,5-100	138-100	137-100	131,5-125	122,5-125	109-150							
				21,5-15	20,7-15	20-15	19,5-15	17-15	14,5-20	11,8-20	8,8-20						
				24,5-15	23,8-15	23-15	22,5-20	20,2-20	17,5-20	15-20	11,8-20						
				28-20	27,3-20	26,5-20	26-20	23,5-20	20,7-25	16,5-25	14,5-25						
				32-20	31,5-20	30,5-20	30-25	27,8-25	25-25	21,5-30	18,5-30						
				35,7-25	35,2-25	34,5-25	34,2-25	32-25	29,5-30	26,5-30	22,6-40	18,5-40					
				39,5-25	39,2-25	38,7-30	38,5-30	37-30	34,8-40	31,8-40	27,8-40	23-40					
				36-25	35,5-25	34,5-25	34-25	31-30	27-30	21,5-30							
				41-25	40,5-25	40-25	39,5-30	37-40	33-40	27,5-40							
				46,5-30	46-30	45,5-40	45-40	42-40	39-40	34-50							
				52-40	51,5-40	51,2-40	51-40	49-50	46,5-50	41-50	35-60						
				58-40	57,5-40	57,2-40	57-50	55-50	52-60	48-60	43-60						
				65-50	65-50	64,5-50	64-50	63-60	60-60	56,5-60	51,5-75	45-75					
				65,5-50	65-50	64-50	63-50	60-60	55,5-60	49-60							
				72-50	71,5-50	71-50	70-60	67-60	63-75	57-75	50-75						
				79-60	78-60	78-60	77-60	74,5-75	71-75	65,5-75	58,5-100						
				85-60	85-60	85-75	84,5-75	82-75	78,5-100	74-100	67,5-100	60,5-100					
				92,5-75	92,5-75	92-75	92-75	89,5-100	86,5-100	82-100	77-100	70-125	61,5-125				
				99-75	99-75	98,5-75	98,5-100	97-100	94-100	89-100	84-125	77-125	69-125				
				105-75	104-75	104-75	101-100	96-100	88-100	77-100							
				117-75	116,5-100	116-100	114-100	111-100	104-125	96,5-125	85-125						
				130-100	129,5-100	129,5-100	127,5-125	124,5-125	120,5-125	113,5-150							
				144-100	143,5-100	143,5-125	142-125	139-150									
				155-125	156-125	156-125	155,5-150										

2.900 r.p.m.



KDN Normalizadas a 2.900 r.p.m. / Standardized to 2.900 r.p.m.

MODELO	Q m³/h l/min	0	120	150	180	210	240	270	300	330	360	420
		0	2000	2500	3000	3500	4000	4500	5000	5500	6000	6000
KDN 100-200 / 180	H (m)	40 - 40		40 - 40	38 - 40	36 - 40	33 - 40	30,5 - 50	28 - 50	25 - 50		
KDN 100-200 / 190		46,5 - 50		45 - 50	44 - 50	42 - 50	39 - 50	37 - 50	34,5 - 60	31 - 60	28 - 60	
KDN 100-200 / 200		51,5 - 50		51 - 50	50 - 50	48,5 - 60	46 - 60	44 - 60	42 - 75	39 - 75	35 - 75	
KDN 100-200 / 210		57,5 - 60		57 - 60	56 - 60	55 - 75	53 - 75	51 - 75	49 - 75	46 - 100	43 - 100	36 - 100
KDN 100-200 / 219		64 - 75		62,5 - 75	62 - 75	61 - 75	60 - 75	58 - 100	56 - 100	53 - 100	50 - 100	43 - 100
KDN 100-250 / 220		61 - 60		61,5 - 60	59,5 - 60	57 - 75	54 - 75	50,5 - 100	46,5 - 100	42 - 100		
KDN 100-250 / 230		67 - 75		68 - 75	66,5 - 75	64 - 75	61 - 100	58 - 100	54 - 100	49 - 100	44 - 100	
KDN 100-250 / 240		73 - 75		76 - 75	74 - 75	71,5 - 100	69 - 100	66 - 100	63 - 100	58,5 - 125	53 - 125	
KDN 100-250 / 250		80 - 100		83 - 100	81,5 - 100	79,5 - 100	77 - 100	74 - 125	71 - 125	67 - 125	62,5 - 150	
KDN 100-250 / 260		88 - 100		90,5 - 100	89,5 - 100	88 - 100	86 - 125	83 - 125	79,5 - 125	76 - 150	71,5 - 150	

N.º negro: **Altura m.c.a.** - N.º verde: **Potencia Nominal en CV**
 N.º black: **Height w.c.m.** - N.º Green: **Nominal Power HP**

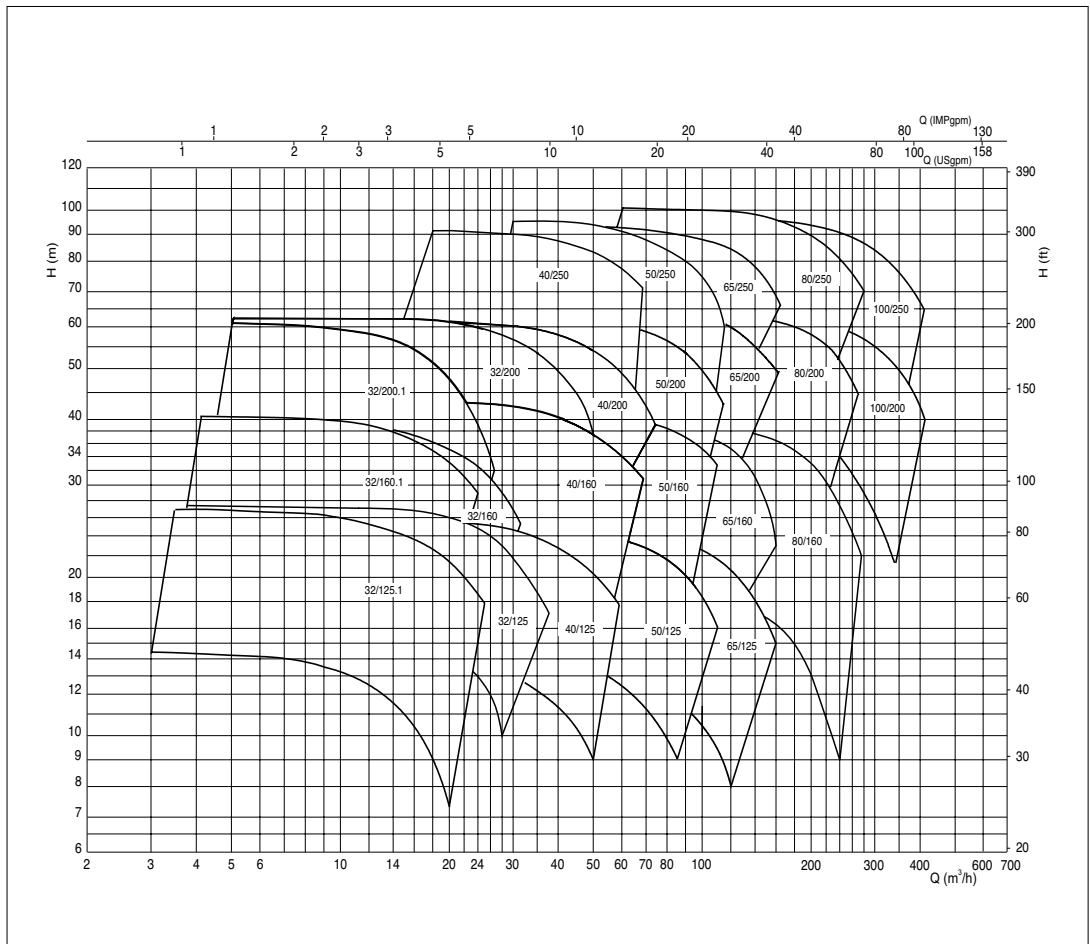

KDN

Normalizadas a 1.450 r.p.m. / Standardized to 1.450 r.p.m.

MODELO	Q m³/h /min	0	3	6	12	18	24	30	36	42	48	54	
		0	50	100	200	300	400	500	500	700	800	900	
KDN 32-125.1 / 105	H (m)	3,4-0,5	3,4-0,5	3,1-0,5									
KDN 32-125.1 / 110		3,9-0,5	3,8-0,5	3,5-0,5									
KDN 32-125.1 / 115		4,25-0,5	4,2-0,5	3,9-0,5									
KDN 32-125.1 / 120		4,7-0,5	4,6-0,5	4,3-0,5									
KDN 32-125.1 / 125		5,1-0,5	5,1-0,5	4,8-0,5									
KDN 32-125.1 / 130		5,6-0,5	5,6-0,5	5,3-0,5									
KDN 32-125.1 / 135		6,1-0,5	6-0,5	5,8-0,5	4,4-0,5								
KDN 32-125.1 / 140		6,6-0,5	6,6-0,5	6,4-0,5	5,1-0,75								
KDN 32-125 / 115		4,3-0,5		4,1-0,5	3,2-0,5								
KDN 32-125 / 120		4,75-0,5		4,6-0,5	3,75-0,5								
KDN 32-125 / 125		5,2-0,5		5,05-0,5	4,2-0,5								
KDN 32-125 / 130		5,7-0,5		5,5-0,5	4,8-0,5								
KDN 32-125 / 135		6,2-0,5		6-0,5	5,3-0,75	3,65-0,75							
KDN 32-125 / 142		6,9-0,5		6,75-0,5	6,15-0,75	4,5-0,75							
KDN 32-160.1 / 137		6-0,5	5,6-0,5	4,6-0,5									
KDN 32-160.1 / 145		6,7-0,5	6,4-0,5	5,5-0,5									
KDN 32-160.1 / 153		7,5-0,5	7,1-0,5	6,4-0,5									
KDN 32-160.1 / 161		8,2-0,5	7,9-0,5	7,3-0,5									
KDN 32-160.1 / 169		9,1-0,5	8,7-0,5	8,1-0,75	5,5-0,75								
KDN 32-160.1 / 177		10,2-0,5	9,8-0,5	9,2-0,75	6,6-1								
KDN 32-160 / 137		5,9-0,5		5,6-0,5	4,4-0,5								
KDN 32-160 / 145		6,7-0,5		6,5-0,5	5,3-0,75								
KDN 32-160 / 153		7,6-0,5		7,4-0,5	6,25-0,75								
KDN 32-160 / 161		8,5-0,75		8,25-0,75	7,25-1	8,7-1							
KDN 32-160 / 169		9,5-0,75		9,3-0,75	8,4-1	6,6-1,5							
KDN 32-160 / 177		10,5-1		10,4-1	9,6-1,5	7,8-1,5							
KDN 32-200.1 / 170		9,4-0,5	8,8-0,5	7,6-0,5									
KDN 32-200.1 / 180		10,5-0,5	10-0,5	9-0,75									
KDN 32-200.1 / 190		11,6-0,75	11,2-0,75	10,3-0,75									
KDN 32-200.1 / 200		12,9-0,75	12,5-0,75	11,6-1	7,6-1,5								
KDN 32-200.1 / 207		13,9-0,75	13,5-0,75	12,6-1	8,8-1,5								
KDN 32-200 / 170		8,6-0,75		8,2-0,75	6,7-0,75								
KDN 32-200 / 180		9,9-0,75		9,6-0,75	8,2-1								
KDN 32-200 / 190		11,2-0,75		10,9-0,75	9,7-1	7-1,5							
KDN 32-200 / 200		12,6-1		12,3-1	11,1-1,5	8,7-1,5							
KDN 32-200 / 210		14,3-1		14-1	13,1-1,5	10,7-2							
KDN 32-200 / 219		15,7-1,5		15,4-1,5	14,8-2	13-2	9,8-3						
KDN 40-125 / 115		4,2-0,5		4,1-0,5	3,8-0,5	3,2-0,5	2,4-0,5						
KDN 40-125 / 120		4,6-0,5		4,5-0,5	4,2-0,5	3,7-0,75	2,9-0,75						
KDN 40-125 / 125		5,1-0,5		4,9-0,5	4,7-0,75	4,1-0,75	3,3-0,75						
KDN 40-125 / 130	5,5-0,5		5,4-0,5	5,2-0,75	4,7-0,75	3,9-0,75							
KDN 40-125 / 135	6-0,5		5,9-0,5	5,8-0,75	5,3-0,75	4,6-1							
KDN 40-125 / 142	6,7-0,75		6,6-0,75	6,5-0,75	6-1	5,3-1	4,1-1,5						
KDN 40-160 / 137	5,9-0,5		6-0,5	5,7-0,75	5-0,75	3,7-0,75							
KDN 40-160 / 145	6,7-0,5		6,8-0,5	6,6-0,75	6-1	4,8-1							
KDN 40-160 / 153	7,6-0,75		7,8-0,75	7,6-1	7-1,5	6-1,5							
KDN 40-160 / 161	8,5-1		8,7-1	8,6-1,5	8-1,5	7,1-1,5	5,6-1,5						
KDN 40-160 / 169	9,6-1		9,7-1	9,6-1,5	9,1-1,5	8,3-1,5	7-1,5						
KDN 40-160 / 177	10,7-1		10,7-1	10,6-1,5	10,2-1,5	9,5-2	8,3-2						
KDN 40-200 / 170	8,4-0,75		8,75-0,75	8,4-1	7,4-1,5	5,7-1,5							
KDN 40-200 / 180	9,7-0,75		10-0,75	9,7-1	8,8-1,5	7,2-1,5							
KDN 40-200 / 190	10,9-1		11,1-1	11-1,5	10,2-1,5	8,8-2	6,8-2						
KDN 40-200 / 200	12,2-1		12,5-1	12,4-1,5	11,7-2	10,4-2	8,6-2						
KDN 40-200 / 210	13,6-1,5		13,9-1,5	13,9-1,5	13,2-2	12,1-3	10,6-3						
KDN 40-200 / 219	15-1,5		15,2-1,5	15,2-2	14,7-3	13,8-3	12,4-3	10,4-3					
KDN 40-250 / 220	15,8-2			15,6-2	14,8-3	13,6-3	12-3						
KDN 40-250 / 230	17,4-2			17,2-2	16,5-3	15,3-3	13,7-4						
KDN 40-250 / 240	19-3			19-3	18,2-3	17-4	15,5-4						
KDN 40-250 / 250	20,7-3			20,6-3	20-4	18,9-4	17,5-5,5						
KDN 40-250 / 260	22,7-3			22,6-3	22,1-4	21-5,5	19,5-5,5						

1.450 r.p.m.



MODELO	Q m³/h /min	0	3	6	12	18	24	30	36	42	48	54	60	
		0	50	100	200	300	400	500	600	700	800	900	1000	
KDN 50-125 / 115		4,2-0,5			4,1-0,5	3,9-0,5	3,6-0,75	3,3-0,75	2,9-0,75	2,3-0,75				
KDN 50-125 / 120		4,6-0,5			4,4-0,5	4,3-0,75	4-0,75	3,7-1	3,3-1	2,8-1				
KDN 50-125 / 125		5-0,75			4,9-0,75	4,7-0,75	4,5-0,75	4,2-1	4,2-1	3,7-1	3,3-1,5			
KDN 50-125 / 130		5,6-0,75			5,4-0,75	5,2-1	5-1	4,7-1,5	4,2-1,5	3,8-1,5	3,2-1,5			
KDN 50-125 / 135		6-1			5,8-1	5,7-1	5,5-1,5	5,2-1,5	4,8-1,5	4,3-1,5	3,8-1,5			
KDN 50-125 / 139		6,3-1			6,9-1	6,1-1,5	5,9-1,5	5,6-1,5	5,2-1,5	4,8-1,5	4,2-1,5			
KDN 50-125 / 144		6,7-1			6,7-1	6,6-1,5	6,4-1,5	6,2-1,5	5,8-1,5	5,3-1,5	4,8-1,5	4,1-1,5		
KDN 50-160 / 137		6,05-0,75			6,1-0,75	5,95-0,75	5,7-1	5,3-1	4,8-1,5	4,2-1,5				
KDN 50-160 / 145		6,8-0,75			6,9-0,75	6,85-1	6,6-1	6,2-1,5	5,8-1,5	5,1-1,5				
KDN 50-160 / 153		7,6-1			7,8-1	7,75-1,5	7,5-1,5	7,2-1,5	6,7-2	6,2-2				
KDN 50-160 / 161		8,4-1			8,6-1	8,65-1,5	8,45-1,5	8,2-2	7,7-2	7,2-2				
KDN 50-160 / 169		9,4-1,5			9,6-1,5	9,6-2	9,45-2	9,2-2	8,8-3	8,3-3				
KDN 50-160 / 177		10,4-1,5			10,5-1,5	10,6-2	10,5-2	10,2-3	9,95-3	9,4-3				
KDN 50-200 / 170		9,5-1,5			9,6-1,5	9,4-1,5	8,8-1,5	8-2	6,85-2					
KDN 50-200 / 180		10,6-1,5			10,8-1,5	10,6-1,5	10,2-2	9,5-3	8,6-3	7,3-3				
KDN 50-200 / 190		11,8-1,5			12-1,5	11,9-2	11,5-3	10,8-3	10,1-3	8,9-3				
KDN 50-200 / 200		13,1-2			13,4-2	13,3-3	12,9-3	12,3-3	11,6-4	10,6-4	9,4-4			
KDN 50-200 / 210		14,6-2			14,8-2	14,8-3	14,5-3	13,9-4	13,2-4	12,2-4	11-4			
KDN 50-200 / 219		16-3			16,2-3	16,2-3	15,9-3	15,4-4	14,2-4	13,8-4	12,7-5,5	11,4-5,5		
KDN 50-250 / 220		16-3			16,3-3	16,1-3	15,5-3	14,9-4	13,8-4	12,4-4	10,5-4			
KDN 50-250 / 230		17,4-3			17,9-3	17,8-3	17,2-4	16,5-4	15,5-4	14,2-5,5	12,6-5,5	10,3-5,5		
KDN 50-250 / 240		19-3			19,5-3	19,5-4	19-4	18,2-5,5	17,4-5,5	16,2-5,5	14,7-7,5	12,4-7,5		
KDN 50-250 / 250		20,8-4			21,3-4	21,3-4	20,9-4	20,1-5,5	19,5-5,5	18,1-7,5	17-7,5	14,8-7,5		
KDN 50-250 / 263		23-4			23,5-4	23,5-4	23,2-5,5	22,5-5,5	21,7-7,5	20,6-7,5	19,4-7,5	17,5-7,5		
KDN 65-125 / 120 / 110		3,75-0,75					3,5-0,75	3,3-0,75	3,2-1	2,9-1	2,7-1	2,3-1	1,9-1	
KDN 65-125 / 120		4,25-1					3,9-1	3,8-1	3,6-1	3,3-1	3,1-1,5	2,7-1,5	2,3-1,5	
KDN 65-125 / 125		4,7-1					4,4-1	4,25-1	4,1-1,5	3,8-1,5	3,6-1,5	3,25-1,5	2,8-1,5	
KDN 65-125 / 130		5,1-1					4,9-1	4,75-1,5	4,6-1,5	4,3-1,5	4,1-1,5	3,8-1,5	3,3-1,5	
KDN 65-125 / 135		5,6-1,5					5,4-1,5	5,3-1,5	5,2-1,5	4,9-1,5	4,7-2	4,3-2	3,9-2	
KDN 65-125 / 140		6-1,5					5,9-1,5	5,8-1,5	5,7-1,5	5,5-1,5	5,2-2	4,9-2	4,5-2	
KDN 65-125 / 144		6,5-1,5					6,35-1,5	6,25-1,5	6,2-2	5,9-2	5,7-2	5,4-2	5-2	
KDN 65-160 / 137		5,8-1					5,7-1	5,4-1	5,2-1,5	4,75-1,5	4,3-1,5	3,7-1,5		
KDN 65-160 / 145		6,5-1,5					6,5-1,5	6,3-1,5	6-1,5	5,7-1,5	5,3-2	4,75-2	4,1-2	
KDN 65-160 / 153		7,3-1,5					7,4-1,5	7,2-1,5	6,9-1,5	6,7-2	6,3-2	5,8-2	5,2-2	
KDN 65-160 / 161		8,2-2					8,25-2	8,15-2	7,9-2	7,7-2	7,3-3	6,85-3	6,3-3	
KDN 65-160 / 169		9,1-2					9,2-2	9,1-2	8,9-3	8,7-3	8,4-3	8-3	7,6-3	
KDN 65-160 / 177		10-3					10,2-3	10,1-3	9,9-3	9,7-3	9,45-3	9,1-3	8,7-4	
KDN 65-200 / 170		9,4-2				9,7-2	9,6-2	9,4-2	9-3	8,5-3	7,9-3	7,1-3	6,5-3	
KDN 65-200 / 180		10,5-2				10,9-2	10,4-2	10,6-3	10,4-3	10-3	9,5-4	8,8-4	8,1-4	
KDN 65-200 / 190		12,1-3				12,3-3	12,4-3	12,2-3	11,9-4	11,6-4	11,1-4	10,5-4	9,8-4	
KDN 65-200 / 200		13,4-3				13,6-3	13,7-3	13,7-4	13,5-4	13,2-4	12,8-4	12,3-5,5	11,6-5,5	
KDN 65-200 / 210		14,8-4				15-4	15,1-4	15-4	14,9-4	14,7-5,5	14,3-5,5	13,8-5,5	13,4-5,5	
KDN 65-200 / 219		16,3-4				16,5-4	16,6-4	16,5-4	16,4-4	16,2-5,5	16-5,5	15,6-5,5	15-7,5	
KDN 65-250 / 220		15,8-4				15,8-4	15,5-4	15,1-4	14,5-5,5	14-5,5	13,2-5,5	12-5,5		
KDN 65-250 / 230		17,4-4				17,4-4	17,2-4	16,8-5,5	16,3-5,5	15,7-5,5	15-7,5	14,1-7,5		
KDN 65-250 / 240		19-5,5				19-5,5	18,9-5,5	18,5-5,5	18,1-7,5	17,5-7,5	16,8-7,5	16-7,5		
KDN 65-250 / 250		20,7-5,5				20,7-5,5	20,6-5,5	20,4-7,5	20-7,5	19,5-7,5	18,8-7,5	18-7,5		
KDN 65-250 / 263		23,2-7,5				23,2-7,5	23-7,5	22,9-7,5	22,5-7,5	22,2-7,5	21,6-7,5	20,8-10		
KDN 65-315 / 260		22,2-7,5				22,2-7,5	22,1-7,5	22-7,5	21,5-7,5	21-7,5	21-10	20,5-10	20-10	
KDN 65-315 / 275		25,1-7,5				25,1-7,5	25-7,5	24,8-7,5	24,6-10	24,1-10	23,5-10	23-10		
KDN 65-315 / 290		28,1-7,5				28,1-7,5	28,1-7,5	28-10	27,8-10	27,3-10	27-10	26,5-15		
KDN 65-315 / 305		31,8-10				31,8-10	31,8-10	31,7-10	31,5-10	31,2-10	30,8-15	30,4-15		
KDN 65-315 / 320		35,7-10				35,7-10	35,3-10	35,2-15	35,1-15	35-15	34,8-15	34,5-15		

MODELO	Q m³/h l/min	0	3	6	12	18	24	30	36	42	48	54	60
		0	50	100	200	300	400	500	600	700	800	900	1000
KDN 80-160 / 147 / 127	H (m)	5,7 - 2								5,4 - 2	5,25 - 2	5,05 - 2	4,8 - 2
KDN 80-160 / 153 / 136		6,4 - 3								6,2 - 3	6,05 - 3	5,85 - 3	5,7 - 3
KDN 80-160 / 153		7,3 - 3								7,1 - 3	6,9 - 3	6,7 - 3	6,5 - 3
KDN 80-160 / 161		8,2 - 3								8 - 3	7,9 - 3	7,75 - 3	7,5 - 3
KDN 80-160 / 169		9,1 - 4								9 - 4	8,85 - 4	8,7 - 4	8,6 - 4
KDN 80-160 / 177		10 - 4								9,9 - 4	9,85 - 4	9,8 - 4	9,7 - 4
KDN 80-200 / 170		9,2 - 4								9,1 - 4	9 - 4	8,7 - 4	8,5 - 4
KDN 80-200 / 180		10,3 - 4								10,4 - 4	10,2 - 4	10 - 4	9,9 - 4
KDN 80-200 / 190		11,4 - 4								11,7 - 4	11,6 - 4	11,5 - 5,5	11,3 - 5,5
KDN 80-200 / 200		12,7 - 5,5								13 - 5,5	13 - 5,5	12,8 - 7,5	12,7 - 7,5
KDN 80-200 / 210		14,1 - 5,5								14,5 - 5,5	14,4 - 5,5	14,4 - 7,5	14,2 - 7,5
KDN 80-200 / 222		15,9 - 7,5								16,2 - 7,5	16,2 - 7,5	16,1 - 7,5	16,1 - 7,5
KDN 80-250 / 220		16 - 7,5								16,4 - 7,5	16,2 - 7,5	16,1 - 7,5	15,9 - 7,5
KDN 80-250 / 230		17,3 - 7,5								18 - 7,5	17,9 - 7,5	17,7 - 7,5	17,5 - 7,5
KDN 80-250 / 240		19 - 7,5								19,7 - 7,5	19,6 - 7,5	19,5 - 7,5	19,3 - 10
KDN 80-250 / 250		20,6 - 10								21,4 - 10	21,3 - 10	21,2 - 10	21 - 10
KDN 80-250 / 260		22,6 - 10								23,1 - 10	23 - 10	22,9 - 10	22,8 - 10
KDN 80-250 / 270		24,5 - 10								24,8 - 10	24,7 - 10	24,6 - 10	24,5 - 10
KDN 80-315 / 275		24,9 - 15									25,5 - 15	25,4 - 15	25,3 - 15
KDN 80-315 / 290		28 - 15									28,8 - 15	28,6 - 15	28,3 - 15
KDN 80-315 / 305		31,4 - 15									32,1 - 15	32 - 15	32 - 15
KDN 80-315 / 320		34,8 - 20									35,8 - 20	35,9 - 20	35,8 - 20
KDN 80-315 / 334		38,3 - 20									39 - 20	39,1 - 20	39,1 - 20
KDN 100-200 / 180		10,2 - 7,5											10,1 - 7,5
KDN 100-200 / 190		11,6 - 7,5											11,5 - 7,5
KDN 100-200 / 200		12,9 - 7,5											12,8 - 7,5
KDN 100-200 / 210		14,3 - 10											14,2 - 10
KDN 100-200 / 219		16 - 10											15,7 - 10
KDN 100-250 / 220		15,2 - 10											15,6 - 10
KDN 100-250 / 230		16,9 - 10											17,4 - 10
KDN 100-250 / 240		18,5 - 15											19,1 - 15
KDN 100-250 / 250		20,1 - 15											20,7 - 15
KDN 100-250 / 260		22,3 - 15											22,7 - 15
KDN 100-250 / 270		24,3 - 15											24,6 - 15
KDN 100-315 / 275		25 - 15											25,5 - 15
KDN 100-315 / 290		28 - 20											28,5 - 20
KDN 100-315 / 305		31,2 - 20											31,8 - 20
KDN 100-315 / 320		34,5 - 25											35 - 25
KDN 100-315 / 334		38,1 - 25											38,1 - 25
KDN 125-250 / 220		15 - 15											
KDN 125-250 / 230		16,7 - 15											
KDN 125-250 / 240		18,2 - 20											
KDN 125-250 / 250		19,9 - 20											
KDN 125-250 / 260		21,8 - 25											
KDN 125-250 / 269		24 - 25											
KDN 150-200 / 210 / 170	9,2 - 15												
KDN 150-200 / 218 / 182	10,5 - 15												
KDN 150-200 / 218 / 200	11,6 - 15												
KDN 150-200 / 218	12,9 - 20												
KDN 150-200 / 224	13,8 - 20												

66	72	78	84	90	102	114	120	150	180	210	240	270	300	330	360	390	420
1100	1200	1300	1400	1500	1700	1900	2000	2500	3000	3500	4000	4500	5000	5500	6000	6500	7000

4,6-2	4,35-3	4,15-3	3,85-3	3,6-3	3,1-3	2,5-3	2,2-3										
5,4-3	5,15-3	4,8-3	4,65-3	4,4-3	3,85-3	3,3-3	3-3										
6,3-3	6-3	5,75-3	5,4-3	5,2-3	4,55-4	3,9-4	3,6-4										
7,3-3	7,05-4	6,8-4	6,5-4	6,25-4	5,6-4	4,9-4	4,6-4										
8,35-4	8,1-4	7,85-4	7,6-4	7,3-4	6,75-5,5	6-5,5	5,7-5,5										
9,5-4	9,3-5,5	9,1-5,5	8,85-5,5	8,7-5,5	8,1-5,5	7,25-5,5	6,9-5,5										
8,2-4	7,8-4	7,5-4	7,1-4	6,7-5,5	5,6-5,5												
9,6-4	9,2-5,5	9-5,5	8,6-5,5	8,2-5,5	7,2-5,5												
11-5,5	10,7-5,5	10,5-5,5	10,1-7,5	9,8-7,5	8,7-7,5	6,8-7,5											
12,5-7,5	12,3-7,5	12-7,5	11,6-7,5	11,4-7,5	10,5-7,5	9,4-7,5	8,8-7,5										
14,1-7,5	13,9-7,5	13,7-7,5	13,3-7,5	13,1-7,5	12,1-7,5	11,2-10	10,6-10										
16-7,5	15,7-7,5	15,6-7,5	15,3-7,5	15-10	14,3-10	13,4-10	12,8-10										
15,5-7,5	15,2-7,5	14,9-7,5	14,5-7,5	13,9-10	12,8-10												
17,2-7,5	16,9-10	16,5-10	16-10	15,5-10	14,3-10	12,4-10											
19-10	18,7-10	18,4-10	18-10	17,6-10	16,6-15	15,3-15	14,6-15										
20,8-10	20,6-10	20,3-10	19,9-15	19,6-15	18,6-15	17,4-15	16,8-15										
22,6-10	22,4-15	22,1-15	21,8-15	21,4-15	20,6-15	19,6-15	19-15	15,1-15									
24,4-15	24,3-15	24,1-15	23,7-15	23,3-15	22,4-15	21,4-15	20,7-15	16,3-20									
25,1-15	25-15	24,8-15	24,3-15	24-15	23-15	21,4-20	20,5-20										
28,3-15	28,1-15	28-15	27,5-15	27,4-15	26,5-20	25-20	24,6-20	19,1-20									
32-20	31,8-20	31,5-20	31,2-20	30,9-20	30-20	29-25	28,5-25	24-25									
35,6-20	35,4-20	35-20	34,9-20	34,7-20	34-20	33,2-25	32,8-25	28,8-30									
39-20	38,8-20	38,6-20	38,5-20	38,3-25	37,9-25	37-25	36,9-30	33,1-30	28-40								
10,1-7,5	10-7,5	9,9-7,5	9,7-7,5	9,5-7,5	9,1-7,5	8,5-7,5	8,3-7,5	7-7,5	5,4-7,5								
11,4-7,5	11,3-7,5	11,2-7,5	11,1-7,5	11-7,5	10,5-7,5	10,1-7,5	10-7,5	8,6-10	7-10								
12,8-7,5	12,8-7,5	12,7-7,5	12,6-10	12,5-10	12,2-10	11,8-10	11,6-10	10,4-10	8,8-10								
14,2-10	14,2-10	14,2-10	14,1-10	14-10	13,8-10	13,5-10	13,3-10	12,3-15	10,7-15	9-15							
15,7-10	15,6-10	15,6-10	15,5-10	15,5-10	15,3-10	15,1-15	15-15	14-15	12,5-15	10,8-15							
15,5-10	15,3-10	15,2-10	15-10	14,8-10	14,3-10	13,7-15	13,4-15	11,4-15									
17,3-10	17,2-10	17-10	16,8-15	16,6-15	16,2-15	15,7-15	15,3-15	13,6-15	11,1-15								
19-15	18,9-15	18,8-15	18,6-15	18,5-15	18,2-15	17,6-15	17,4-15	15,7-20	13,3-20								
20,7-15	20,6-15	20,5-15	20,4-15	20,3-15	20-15	19,4-15	19,2-15	17,6-20	15,4-20								
22,7-15	22,6-15	22,5-15	22,5-15	22,4-15	22,1-15	21,6-15	21,4-20	19,8-20	17,7-20	15,1-20							
24,6-15	24,6-15	24,6-15	24,5-15	24,4-15	24,1-20	23,7-20	23,5-20	22,1-20	20,1-25	17,3-25							
25,4-15	25,3-15	25,2-15	25,1-15	25-15	24,7-20	24,4-20	24-20	22-20	19-25								
28,5-20	28,5-20	28,4-20	28,3-20	28,2-20	28-20	27,7-20	27-20	25,5-25	23-25								
31,8-20	31,8-20	31,7-20	31,6-20	31,5-20	31,2-25	30,8-25	30,5-25	29-30	27-30	24-40							
35-25	35-25	35-25	35-25	35-25	34,8-25	34,5-25	34,2-25	33-30	31-40	28,1-40							
38,1-25	38,1-25	38,1-25	38-25	38-25	37,7-30	37,5-30	37,3-30	36,5-40	34,8-40	32-40	28,8-40						
					15,5-15	15,5-15	15,4-15	14,8-15	14-15	13-15	11,8-20	10,5-20	9,2-20				
					17,1-15	17-15	17-15	16,5-15	15,8-20	14,8-20	13,8-20	12,5-20	12,3-20	9,5-20			
					18,5-20	18,5-20	18,5-20	18,2-20	17,6-20	16,8-20	15,8-20	14,5-25	13,3-25	11,6-25	10,1-25		
					20-20	20-20	20-20	19,9-20	19,5-20	18,7-25	17,8-25	16,6-25	15,5-25	14-30	12,3-30		
					22-25	22-25	22-25	21,7-25	21,3-25	20,6-25	19,9-25	18-30	17,7-30	16,3-30	14,6-30	13-30	
					23,9-25	23,9-25	23,8-25	23,6-25	23,2-25	22,7-30	22,1-30	22,2-30	20,2-40	19-40	17,5-40	15,6-40	14-40
							9,1-15	8,9-15	8,6-15	8,3-15	7,9-15	7,5-15	6,8-15	5,9-15	5,4-15		
							10,3-15	10,2-15	9,9-15	9,5-15	9,1-15	8,6-15	8,1-15	7,4-15	6,6-15		
							11,4-15	11,2-15	10,9-15	10,5-15	10,1-20	9,7-20	9,2-20	8,5-20	7,8-20	6,9-20	5,9-20
							12,6-20	12,4-20	12,1-20	11,6-20	11,1-20	10,7-20	10,2-20	9,5-20	8,8-20	8-20	7,1-20
							13,5-20	13,3-20	13-20	12,6-20	12,2-20	11,7-20	11,2-20	10,6-20	9,9-20	9,1-20	8,2-20

1.450 r.p.m.





SUMERGIBLES

POZO / SONDEO		AGUAS SUCIAS	
104	AR	121	VORT
108	SP	122	COMPACTA
112	AS	123	VG
114	SX	124	GRIX / GT / GX
119	FR	126	HT
120	FRANKLIN	127	M
		130	VT
		132	VN
		133	FEKAFOS
		DRENAJE	
		134	DRX
		135	DG
		136	ACCESORIOS

AR



Aplicaciones:

Bombas sumergibles de 4" multiturbinas de elevado rendimiento hidráulico especialmente indicadas para la elevación, distribución y presurización en instalaciones hidráulicas civiles e industriales. Montaje en equipos de presión, cisternas, sistemas de riego, de lavado, etc....

Características constructivas:

Soporte y cuerpo superior (con válvula de retención incorporada) en Acero inoxidable AISI 304 de fundición. Incorporan un nuevo sistema antibloqueo «Turbinas flotantes» generan una «altísima resistencia al desgaste» y máxima robustez y fiabilidad en el tiempo. Turbinas en Noryl y difusores en policarbonato. Eje en acero inoxidable AISI 304. Camisa exterior en acero inoxidable AISI 304. Manguito guía superior interno en caucho. Rejilla, cubre cable y válvula de retención en acero inoxidable AISI 304.

Motor:

Podemos escoger entre dos tipos de motor:

Motor FRANKLIN que cumple con la normativa DIN e ISO y cuyas características principales son: Estator hermético en acero inoxidable, acoplamiento internacional tipo NEMA, no necesita mantenimiento y están lubricados por agua.

Motor FR que cumple con la normativa DIN e ISO y



cuyas características principales son: Estator de acero inoxidable en baño de aceite atóxico, acoplamiento internacional tipo NEMA, no necesita mantenimiento.

Temperatura máxima del agua: + 30° C

Máximo contenido en arena: 50 gr/m³



Applications:

4" submersible pumps with multiple impellers with a high hydraulic performance, especially recommended for elevation, distribution and pressurisation in civil and industrial hydraulic installations. Assembly in pressure units, cisterns, irrigation, washing systems, etc.

Constructive characteristics:

Support and upper body (with built-in retention valve) in cast AISI 304 stainless steel.

They incorporate a new "Floating Impeller" That generate and **high resistance to wear** and maximum solidity and reliability with time.

Impellers and diffusers in Technopolymer "A".

Exterior cladding in AISI 304 stainless steel.

Motor:

We can choose between two types of motors:

FRANKLIN motor complying with DIN and ISO standards with the following main features: Hermetic stator in stainless steel, international NEMA coupling, no need for maintenance, water lubricated.

FR motor complying with DIN and ISO standards with the following main features: Stator in stainless steel, international NEMA coupling, no need for maintenance, atoxic oil lubricated.

Maximum water temperature: + 30° C.

Maximum content of sand in water: 50 gr/m³

Tipo Type	Voltaje Voltage	Cond. µF	Potencia		"A"	Caudal m ³ /h / Flow m ³ /h						Longitud Lenght	
			HP	KW		0	0,6	0,9	1,2	1,5	2,1		2,4
						Altura m.c.a. / Height w.c.m.							
AR 15-19 M	II 230	20	0,75	0,55	4,3	126	105	86	60	30			752
AR 15-19 T	III 230	-			2,8								723
AR 15-19 T	III 400	-			1,6								723
AR 15-26 M	II 230	35	1	0,75	5,7	173	141	117	81	39			941
AR 15-26 T	III 230	-			3,7								913
AR 15-26 T	III 400	-			2,1								913
AR 15-38 M	II 230	40	1,5	1,1	8,6	253	208	169	117	52			1191
AR 15-38 T	III 230	-			5,2								1163
AR 15-38 T	III 400	-			3,0								1163
AR 20-15 M	II 230	20	0,75	0,55	4,3	95	85	79	72	64	41	38	691
AR 20-15 T	III 230	-			2,8								662
AR 20-15 T	III 400	-			1,6								662
AR 20-20 M	II 230	35	1	0,75	5,7	127	115	107	95	83	56	40	809
AR 20-20 T	III 230	-			3,7								781
AR 20-20 T	III 400	-			2,1								781
AR 20-30 M	II 230	40	1,5	1,1	8,6	195	183	170	155	137	92	69	1057
AR 20-30 T	III 230	-			5,2								1029
AR 20-30 T	III 400	-			3								1029
AR 20-36 M	II 230	50	2	1,5	10,6	234	218	202	185	153	110	80	1186
AR 20-36 T	III 230	-			6,9								1157
AR 20-36 T	III 400	-			4								1157

Ø Impulsión: 1 1/4" - Outlet Ø: 1 1/4"

AR

Tipo Type	Voltage Voltage	Cond. µF	Potencia		"A"	Caudal m³/h / Flow m³/h										Longitud Lenght		
			HP	KW		0	1,5	2,4	2,7	3,0	3,6	4,2	4,8	5,4	6			
						Altura m.c.a. / Height w.c.m.												
AR 30-10 M	II 230	20			4,3													595
AR 30-10 T	III 230	-	0,75	0,55	2,8	69	60	44	37	29								566
AR 30-10 T	III 400	-			1,6													566
AR 30-14 M	II 230	35			5,7													693
AR 30-14 T	III 230	-	1	0,75	3,7	92	79	60	52	42								665
AR 30-14 T	III 400	-			2,1													665
AR 30-20 M	II 230	40			8,6													826
AR 30-20 T	III 230	-	1,5	1,1	5,2	139	120	90	75	60								798
AR 30-20 T	III 400	-			3,0													798
AR 40-11 M	II 230	35			5,7													722
AR 40-11 T	III 230	-	1	0,75	3,7	72	66	58	54	49	38	26						707
AR 40-11 T	III 400	-			2,1													707
AR 40-16 M	II 230	40			8,6													835
AR 40-16 T	III 230	-	1,5	1,1	5,2	106	98	83	77	70	54	33						810
AR 40-16 T	III 400	-			3													810
AR 40-21 M	II 230	50			10,6													875
AR 40-21 T	III 230	-	2	1,5	6,9	142	132	115	108	100	79	49						846
AR 40-21 T	III 400	-			4													846
AR 40-32 T	III 230	-			10,2													1227
AR 40-32 T	III 400	-	3	2,2	5,9	208	194	165	152	138	104	62						1227
AR 60-07 M	II 230	20			4,3													572
AR 60-07 T	III 230	-	0,75	0,55	2,8	46	43	40	39	37	33	28	21	13	7			543
AR 60-07 T	III 400	-			1,6													543
AR 60-09 M	II 230	35			5,7													643
AR 60-09 T	III 230	-	1	0,75	3,7	59	55	51	49	47	43	37	28	20	10			615
AR 60-09 T	III 400	-			2,1													615
AR 60-14 M	II 230	40			8,6													779
AR 60-14 T	III 230	-	1,5	1,1	5,2	93	87	81	79	76	68	58	47	33	20			751
AR 60-14 T	III 400	-			3,0													751
AR 60-18 M	II 230	50			10,6													894
AR 60-18 T	III 230	-	2	1,5	6,9	120	113	105	102	98	88	75	60	42	25			865
AR 60-18 T	III 400	-			4,0													865
AR 60-27 T	III 230	-			10,2													1123
AR 60-27 T	III 400	-	3	2,2	5,9	175	164	152	147	141	127	109	87	61	35			1123
AR 60-35 T	III 230	-			13,5													1441
AR 60-35 T	III 400	-	4	3	7,8	231	217	202	196	189	170	149	120	87	50			1441
AR 60-48 T	III 230	-			17,3													1836
AR 60-48 T	III 400	-	5,5	4	10,0	322	299	276	267	256	231	199	160	118	70			1836

AR

Tipo Type	Voltaje Voltage	Cond. µF	Potencia		"A"	Caudal m ³ /h / Flow m ³ /h										Longitud Lenght
			HP	KW		0	3,0	3,6	4,2	4,8	5,4	6	7,2	8,4	9,6	
						Altura m.c.a. / Height w.c.m.										
AR 110-07 M	II 230	35	1	0,75	5,7	42	36	34	32	30	28	25	19	11	689	
AR 110-07 T	III 230	-			3,7										661	
AR 110-07 T	III 400	-			2,1										661	
AR 110-10 M	II 230	40	1,5	1,1	8,6	62	53	51	48	45	41	38	29	18	810	
AR 110-10 T	III 230	-			5,2										782	
AR 110-10 T	III 400	-			3,0										782	
AR 110-14 M	II 230	50	2	1,5	10,6	90	77	74	71	68	63	59	46	28	963	
AR 110-14 T	III 230	-			6,9										934	
AR 110-14 T	III 400	-			4,0										934	
AR 110-20 T	III 230	-	3	2,2	10,2	125	107	102	97	92	86	80	62	40	1187	
AR 110-20 T	III 400	-			5,9										1187	
AR 110-27 T	III 230	-	4	3	13,5	169	145	139	131	123	115	107	84	55	1555	
AR 110-27 T	III 400	-			7,8										1555	
AR 110-36 T	III 230	-	5,5	4	17,3	221	190	181	173	164	154	143	112	72	1901	
AR 110-36 T	III 400	-			10,0										1901	

Ø Impulsión: 2" - Outlet Ø: 2"

Tipo Type	Voltaje Voltage	Cond. µF	Potencia		"A"	Caudal m ³ /h / Flow m ³ /h								Longitud Lenght	
			HP	KW		0	4,8	5,4	6	7,2	8,4	9,6	10,8		12
						Altura m.c.a. / Height w.c.m.									
AR 140-06 M	II 230	40	1,5	1,1	8,6	39	36	35	34	32	29	26	22	17	683
AR 140-06 T	III 230	-			5,2										655
AR 140-06 T	III 400	-			3,0										655
AR 140-08 M	II 230	50	2	1,5	10,6	52	48	47	46	43	39	35	29	24	774
AR 140-08 T	III 230	-			6,9										745
AR 140-08 T	III 400	-			4,0										745
AR 140-13 T	III 230	-	3	2,2	10,2	82	75	73	71	66	59	50	40	30	929
AR 140-13 T	III 400	-			5,9										929
AR 140-17 T	III 230	-	4	3	13,5	108	98	96	94	87	79	70	58	46	1204
AR 140-17 T	III 400	-			7,8										1204
AR 140-23 T	III 230	-	5,5	4	17,3	148	134	131	127	118	108	95	79	60	1504
AR 140-23 T	III 400	-			10,0										1504
AR 140-32 T	III 230	-	7,5	5,5	23,7	202	182	178	172	160	143	125	105	80	1936
AR 140-32 T	III 400	-			13,7										1936

Ø Impulsión: 2" - Outlet Ø: 2"

AR

Tipo Type	Voltaje Voltage	Cond. µF	Potencia		"A"	Caudal m ³ /h / Flow m ³ /h										Longitud Lenght
			HP	KW		0	6	7,2	8,4	9,6	10,8	12	13,2	14,4	15,6	
						Altura m.c.a. / Height w.c.m.										
AR 200-07 M	II 230	50	2	1,5	10,6	45	37	36	33	31	28	25	22	18	14	890
AR 200-07 T	III 230	-			6,9											861
AR 200-07 T	III 400	-			4											861
AR 200-10 T	III 230	-	3	2,2	10,2	64	54	52	48	44	41	36	32	26	20	1046
AR 200-10 T	III 400	-			5,9											1046
AR 200-14 T	III 230	-	4	3	13,5	89	76	72	67	62	56	49	43	35	28	1496
AR 200-14 T	III 400	-			7,8											1496
AR 200-19 T	III 230	-	5,5	4	17,3	120	102	97	91	89	76	68	58	48	37	1778
AR 200-19 T	III 400	-			10											1778
AR 200-26 T	III 230	-	7,5	5,5	23,7	163	136	129	120	111	100	87	75	61	48	2257
AR 200-26 T	III 400	-			13,7											2257

Ø Impulsión: 2" - Outlet Ø: 2"

Tipo Type	Voltaje Voltage	Cond. µF	Potencia		"A"	Caudal m ³ /h / Flow m ³ /h										Longitud Lenght
			HP	KW		0	5,4	7,2	8,4	9,6	10,8	12	14	18	24	
						Altura m.c.a. / Height w.c.m.										
AR 250-08 T	III 230	-	3	2,2	10,2	51			41	39	37	35	32	24	12	1032
AR 250-08 T	III 400	-			5,9											1032
AR 250-11 T	III 230	-	4	3	13,5	70			57	54	52	49	45	34	18	1387
AR 250-11 T	III 400	-			7,8											1387
AR 250-15 T	III 230	-	5,5	4	17,3	97			79	76	73	69	64	50	27	1732
AR 250-15 T	III 400	-			10,0											1732
AR 250-20 T	III 230	-	7,5	5,5	23,7	125			102	98	94	89	81	65	37	2187
AR 250-20 T	III 400	-			13,7											2187

Ø Impulsión: 2" - Outlet Ø: 2"

SP

en acero inoxidable
AISI-304



Aplicaciones:

Bombas sumergibles de 4" multiturbinas de elevado rendimiento hidráulico, especialmente indicadas para la elevación, distribución y presurización en instalaciones hidráulicas civiles e industriales. Montaje en equipos de presión, cisternas, sistemas de riego, de lavado, etc....

Características constructivas:

Bombas sumergibles con turbinas, difusores, camisa, cuerpo aspiración, cuerpo impulsión, cubrecables, rejilla de aspiración y tornillos en acero inoxidable **AISI-304**.

Válvula de retención de acero inoxidable incorporada. Casquillos guías en goma especial resistentes a la abrasión.

Turbinas equilibradas estáticamente y dinámicamente.

Máximo contenido en arena 50 gr/m³.

Motor:

Podemos escoger entre dos tipos de motor:

Motor FRANKLIN que cumple con la normativa DIN e ISO y cuyas características principales son: Estator hermético en acero inoxidable, acoplamiento internacional tipo NEMA, no necesita mantenimiento y están lubricados por agua.

Motor FR que cumple con la normativa DIN e ISO y cuyas características principales son: Estator en acero inoxidable en baño de aceite atóxico, acoplamiento internacional tipo NEMA, no necesita mantenimiento.

Temperatura máxima del agua: + 30° C



Applications:

4" submersible pumps with multiple impellers with a high hydraulic yield, especially recommended for elevation, distribution and pressurisation in civil and industrial hydraulic installations. Assembly in pressure units, cisterns, irrigation, washing systems, etc.

Constructive characteristics:

Impellers, difusors, inlet and outlet body, completely manufactured in stainless steel **AISI-304**.

Guide ring in rubber resistant against abrasion. Static and dynamic balanced impellers.

Maximum content of sand in water 50 gr./m³.

Motor:

We can choose between two types of motors:

FRANKLIN motor complying with DIN and ISO standards with the following main features: Hermetic stator in stainless steel, international NEMA coupling, no need for maintenance, water lubricated.

FR motor complying with DIN and ISO standards with the following main features: Stator in stainless steel, international NEMA coupling, no need for maintenance, atoxic oil lubricated.

Maximum water temperature: + 30° C.



SP

en acero inoxidable
AISI-304



Tipo Type	Voltaje Voltage	Cond. µF	Potencia		"A"	Caudal m ³ /h / Flow m ³ /h							Longitud Lenght
			HP	KW		0	0,9	1,2	1,5	1,8	2,1	2,4	
						Altura m.c.a. / Height w.c.m.							
SP 10-13 M	II 230	20			4,3								711
SP 10-13 T	III 230	-	0,75	0,55	2,8	77	71	68	61	56	48	38	682
SP 10-13 T	III 400	-			1,6								682
SP 10-18 M	II 230	35			5,7								843
SP 10-18 T	III 230	-	1	0,75	3,7	106	98	92	84	77	66	51	816
SP 10-18 T	III 400	-			2,1								816
SP 10-23 M	II 230	40			8,6								977
SP 10-23 T	III 230	-	1,5	1,1	5,2	136	124	118	108	98	84	67	949
SP 10-23 T	III 400	-			3,0								949
SP 10-33 M	II 230	50			10,6								1239
SP 10-33 T	III 230	-	2	1,5	6,9	195	181	171	157	141	120	97	1210
SP 10-33 T	III 400	-			4,0								1210
SP 10-48 T	III 230	-	3	2,2	10,2	282	258	241	221	199	171	137	1554
SP 10-48 T	III 400	-			5,9								1554

Ø Impulsión: 1 1/4" - Outlet Ø: 1 1/4"

SP en acero inoxidable AISI-304

Tipo <i>Type</i>	Voltaje <i>Voltage</i>	Cond. μ F	Potencia		"A"	Caudal m ³ /h / Flow m ³ /h										Longitud <i>Length</i>
			HP	KW		0	0,9	1,2	1,5	1,8	2,1	2,4	3	3,6	4,2	
						Altura m.c.a. / Height w.c.m.										
SP 18-9 M	II 230	20	0,75	0,55	4,3	58	56	55	54	52	49	48	43	36	25	627
SP 18-9 T	III 230	-			2,8											598
SP 18-9 T	III 400	-			1,6											598
SP 18-12 M	II 230	35	1	0,75	5,7	78	74	70	67	65	62	59	52	42	28	717
SP 18-12 T	III 230	-			3,7											690
SP 18-12 T	III 400	-			2,1											690
SP 18-18 M	II 230	40	1,5	1,1	8,6	117	109	105	101	98	93	89	78	64	42	872
SP 18-18 T	III 230	-			5,2											844
SP 18-18 T	III 400	-			3,0											844
SP 18-25 M	II 230	50	2	1,5	10,6	162	151	146	140	134	128	121	106	86	58	1048
SP 18-25 T	III 230	-			6,9											1019
SP 18-25 T	III 400	-			4,0											1019
SP 18-33 T	III 230	-	3	2,2	10,2	212	197	189	180	173	168	160	138	109	73	1239
SP 18-33 T	III 400	-			5,9											1239
SP 18-45 T	III 230	-	4	3	13,5	292	271	261	250	243	233	223	195	153	107	1642
SP 18-45 T	III 400	-			7,8											1642

Ø Impulsión: 1 1/4" - Outlet Ø: 1 1/4"

Tipo <i>Type</i>	Voltaje <i>Voltage</i>	Cond. μ F	Potencia		"A"	Caudal m ³ /h / Flow m ³ /h										Longitud <i>Length</i>
			HP	KW		0	1,8	2,1	2,4	3	3,6	4,2	4,8	5,4	6	
						Altura m.c.a. / Height w.c.m.										
SP 25-6 M	II 230	20	0,75	0,55	4,3	38	34	33	32	30	28	26	24	21	17	564
SP 25-6 T	III 230	-			2,8											535
SP 25-6 T	III 400	-			1,6											535
SP 25-8 M	II 230	35	1	0,75	5,7	57	44	43	42	40	38	35	32	28	22	633
SP 25-8 T	III 230	-			3,7											606
SP 25-8 T	III 400	-			2,1											606
SP 25-12 M	II 230	40	1,5	1,1	8,6	75	68	66	65	63	58	53	49	42	36	746
SP 25-12 T	III 230	-			5,2											718
SP 25-12 T	III 400	-			3,0											718
SP 25-17 M	II 230	50	2	1,5	10,6	106	95	92	90	85	79	73	67	58	50	880
SP 25-17 T	III 230	-			6,9											851
SP 25-17 T	III 400	-			4,0											851
SP 25-21 T	III 230	-	3	2,2	10,2	131	117	114	110	103	98	90	82	72	62	964
SP 25-21 T	III 400	-			5,9											964
SP 25-25 T	III 230	-	3	2,2	10,2	156	140	136	131	127	118	110	100	90	74	1048
SP 25-25 T	III 400	-			5,9											1048
SP 25-33 T	III 230	-	4	3	13,5	206	182	178	173	165	155	142	130	115	98	1375
SP 25-33 T	III 400	-			7,8											1375
SP 25-44 T	III 230	-	5,5	4	17,3	275	244	239	232	221	208	191	174	155	130	1682
SP 25-44 T	III 400	-			10,0											1682

Ø Impulsión: 1 1/2" - Outlet Ø: 1 1/2"

SP en acero inoxidable AISI-304

Tipo Type	Voltaje Voltage	Cond. µF	Potencia		"A"	Caudal m³/h / Flow m³/h										Longitud Lenght	
			HP	KW		2,4	3	3,6	4,2	4,8	5,4	6	8,4	9,6	11		
						Altura m.c.a. / Height w.c.m.											
SP 40-07 M	II 230	40			8,6												823
SP 40-07 T	III 230	-	1,5	1,1	5,2	36	34	34	33	33	32	32	25	20	15		795
SP 40-07 T	III 400	-			3,0												
SP 40-10 M	II 230	50			10,6												977
SP 40-10 T	III 230	-	2	1,5	6,9	52	51	51	50	50	49	49	40	34	27		949
SP 40-10 T	III 400	-			4,0												
SP 40-15 T	III 230	-	3	2,2	10,2	79	77	76	75	73	72	70	60	50	40		1188
SP 40-15 T	III 400	-			5,9												
SP 40-18 T	III 230	-	4	3	13,5	91	89	88	87	85	83	81	70	60	48		1465
SP 40-18 T	III 400	-			7,8												
SP 40-25 T	III 230	-	5,5	4	17,3	131	128	126	122	119	116	113	97	81	61		1835
SP 40-25 T	III 400	-			10,0												

Ø Impulsión: 2" - Outlet Ø: 2"

Tipo Type	Voltaje Voltage	Cond. µF	Potencia		"A"	Caudal m³/h / Flow m³/h										Longitud Lenght	
			HP	KW		6	7,2	8,4	9,6	11	12	13	14	15	18		
						Altura m.c.a. / Height w.c.m.											
SP 70-07 T	III 230	-	3	2,2	10,2												991
SP 70-07 T	III 400	-			5,9	40	39	37	36	35	32	30	28	26	18		
SP 70-10 T	III 230	-	4	3	13,5	58	56	54	52	50	46	43	40	38	26		1337
SP 70-10 T	III 400	-			7,8												
SP 70-13 T	III 230	-	5,5	4	17,3	75	72	70	67	65	60	57	53	49	34		1608
SP 70-13 T	III 400	-			10,0												
SP 70-18 T	III 230	-	7,5	5,5	23,7	104	100	97	93	90	83	78	73	68	46		2048
SP 70-18 T	III 400	-			13,7												
SP 70-25 T	III 230	-	10	7,5	-	145	140	135	130	125	115	109	102	95	65		2579
SP 70-25 T	III 400	-			18,4												

Ø Impulsión: 2" - Outlet Ø: 2"

AS

radiales



Aplicaciones:

Bombas sumergibles para pozos de 6" mínimo, muy adecuadas para aplicaciones civiles o industriales, en riegos por aspersión, comunidades, urbanizaciones, etc...

Características constructivas:

Bombas sumergibles con turbinas flotantes y difusores en Noryl. Cada elemento incorpora anillos de roce en acero inoxidable.

Eje, camisa, manguito, cubrecable, rejilla aspiración aros y tornillos son en acero inoxidable.

Cuerpo de aspiración e impulsión en acero inoxidable.

Válvula de retención incorporada.

Máxima cantidad de arena: 50 g/m³

Límite temperatura agua: +10° C a + 40° C

Motor:

Posibilidad de montaje con motor FRANKLIN y con motor SACI.

Para potencias de hasta 10 CV el motor es de 4". A partir de 10 CV los motores son de 6" y en todos los casos debe especificarse el voltaje requerido.



Applications:

Submersible pumps for 6" wells minimum, highly suitable for civil and industrial installations, in aspersion irrigation, communities, housing estates, etc.

Constructive characteristics:

Submersible pumps with floating impellers and diffusers in Noryl. Each element includes contact rings in stainless steel.

Shaft, cladding, sleeve, cable cover, suction grille, rings and bolts in stainless steel.

Suction and drive body in stainless steel. Built-in stainless steel retention valve.

Maximum amount of sand: 50 g/m³

Maximum water temperature: + 10° C to + 40° C.

Motor:

Possibility to install with FRANKLIN or with SACI motor.

For powers of up to 10 HP, the motor is 4". From 10 HP, the motors are 6" and, in all cases, must adapt to the required voltage.

Tipo Type	Potencia		"A"		Caudal m ³ /h / Flow m ³ /h								Ø Motor	Longitud Lenght
	HP	KW	III 230	III 400	0	7,2	8,4	10,6	12	13,2	15	18		
					Altura m.c.a. / Height w.c.m.									
AS 6/75-6	5,5	4	16,4	9,5	90	83	80	72	67	62	51	30	4"	1161
AS 6/75-9	7,5	5,5	22,1	12,8	135	127	119	108	100	92	78	45		1389
AS 6/75-12	10	7,5	28,2	16,3	183	173	164	149	140	130	110	66	6"	1466
AS 6/75-15	12,5	9,2	36,4	21	230	210	204	186	175	160	136	80		1612
AS 6/75-18	15	11	41,5	24	276	250	235	220	207	190	160	96		1759
AS 6/75-24	20	15	55	32	368	335	322	290	272	250	214	130		2052

Ø impulsión: 3" - Outlet Ø : 3"

Tipo Type	Potencia		"A"		Caudal m ³ /h / Flow m ³ /h								Ø Motor	Longitud Lenght
	HP	KW	III 230	III 400	0	3	6	12	18	24	30	36		
					Altura m.c.a. / Height w.c.m.									
AS 6/135-4	5,5	4	16,4	9,5	55	53	51	47	40	32	22	10	4"	1161
AS 6/135-6	7,5	5,5	22,1	12,8	85	81	76	70	62	50	33	15		1389
AS 6/135-8	10	7,5	28,2	16,3	117	112	108	96	87	70	50	25	6"	1466
AS 6/135-10	12,5	9,2	36,4	21	150	143	135	120	100	93	60	32		1612
AS 6/135-12	15	11	41,5	24	175	168	161	147	130	107	73	38		1759
AS 6/135-16	20	15	55	32	235	225	215	195	175	143	100	50		2052
AS 6/135-20	25	18,5	69,2	40	294	282	270	245	216	180	125	67		2397
AS 6/135-24	30	22	81,2	47	350	337	325	297	265	221	151	80		2690

Ø impulsión: 3" - Outlet Ø : 3"

Tipo Type	Potencia		"A"		Caudal m ³ /h / Flow m ³ /h								Ø Motor	Longitud Lenght
	HP	KW	III 230	III 400	0	6	12	18	24	36	42	48		
					Altura m.c.a. / Height w.c.m.									
AS 6/180-3	5,5	4	16,4	9,5	45	43	40	38	35	24	16	8	4"	1113
AS 6/180-4	7,5	5,5	22,1	12,8	60	57	53	50	46	31	21	11		1287
AS 6/180-5	10	7,5	28,2	16,3	76	72	68	64	59	41	33	14	6"	1310
AS 6/180-6	12,5	9,2	36,4	21	91	87	83	78	72	50	34	17		1402
AS 6/180-8	15	11	41,5	24	121	115	109	103	96	67	47	26		1555
AS 6/180-10	20	15	55	32	152	145	137	130	123	87	61	35		1740
AS 6/180-13	25	18,5	69,2	40	197	189	180	168	155	110	75	40		1985
AS 6/180-15	30	22	81,2	47	227	214	200	190	180	128	89	50		2170

Ø impulsión: 3" - Outlet Ø : 3"

Tipo Type	Potencia		"A"		Caudal m ³ /h / Flow m ³ /h								Ø Motor	Longitud Lenght
	HP	KW	III 230	III 400	0	8	16	24	30	42	52	60		
					Altura m.c.a. / Height w.c.m.									
AS 6/220-3	7,5	5,5	22,1	12,8	37	36	35	32	28	20	14	7	4"	1227
AS 6/220-4	10	7,5	28,2	16,3	50	49	47	43	38	27	25	12		1250
AS 6/220-5	12,5	9,2	36,4	21	63	62	61	56	51	37	27	18	6"	1342
AS 6/220-6	15	11	41,5	24	75	73	71	65	59	44	33	21		1435
AS 6/220-9	20	15	55	32	114	112	110	100	89	66	50	33		1680
AS 6/220-11	25	18,5	69,2	40	139	136	132	121	110	80	61	41		1865
AS 6/220-14	30	22	81,2	47	176	172	167	153	138	101	78	54		2110

Ø impulsión: 3" - Outlet Ø : 3"

SX

semi-axiales
semiaxial



Aplicaciones:

Electrobombas sumergibles de elevado rendimiento y máxima fiabilidad, aptas para grandes suministros, como pueden ser abastecimientos municipales, obras públicas, usos industriales, grandes riegos, etc...

Características constructivas:

Cuerpo impulsión, soporte bomba motor, difusores, turbinas y válvula de retención en acero inoxidable AISI-304 de elevada resistencia. Todos los cojinetes y aros en goma anti-arena para asegurar buena resistencia al desgaste y abrasión. Rejilla aspiración y cubrecable en acero inoxidable. Todas las bombas están diseñadas y preparadas para funcionar en uso continuo con cargas hidroestáticas medianas y elevadas.

TEMPERATURA MÁXIMA AGUA: 45° C.

MÁXIMA CANTIDAD DE ARENA EN EL AGUA: 50g/m³

TIEMPO MÁXIMO FUNCIONANDO CON BOCA

CERRADA: 4 min.

LAS PRESTACIONES SON GARANTIZADAS SEGÚN LOS LÍMITES DE LAS NORMAS ISO 2548 CLASE C.

Motor:

Estator hermético en acero inoxidable, acoplamiento internacional tipo Nema. No necesita mantenimiento, todos los cojinetes incluyendo el axial están lubricados por agua o aceite, según modelo de motor.



Applications:

Submersible electro pumps with high output and maximum reliability, suitable for large supplies such as municipal supplies, public works, industrial uses, large irrigation, etc.

Constructive characteristics:

Drive body, pump motor support, diffusers, impellers and retention valve in high strength stainless steel AISI-304. All bearings and rings in sand resistant rubber to ensure good resistance to wear and abrasion. Suction grille and cable cover in Stainless Steel. All pumps are designed and built to work in continuous use with medium and high hydrostatic loads.

MAXIMUM WATER TEMPERATURE: 45° C

MAXIMUM AMOUNT OF SAND IN THE WATER: 50 g/m³

MAXIMUM TIME WORKING WITH MOUTH CLOSED: 4 min

THE PERFORMANCES ARE GUARANTEED ACCORDING TO THE LIMITS OF THE ISO 2548 STANDARD CLASS C.

Motor:

Hermetic stator in stainless steel, international NEMA coupling, no need for maintenance, all bearings, including the axial, are water or oil lubricated, depending the type of the motor.

Tipo Type	Potencia		Caudal m ³ /h / Flow m ³ /h											
	HP	KW	0	7,2	9	10,8	12,6	14,4	15,3	16,2	18	18,9	19,8	21,6
			Altura m.c.a. / Height w.c.m.											
SX 617-06	5,5	4	68	65	64	61	58	55	52	50	45	42	39	33
SX 617-08	7,5	5,5	90	87	85	82	78	73	70	67	60	56	52	44
SX 617-10	7,5	5,5	113	109	106	102	97	91	87	84	75	70	65	54
SX 617-11	10	7,5	124	120	117	113	107	100	96	92	82	77	71	60
SX 617-13	10	7,5	147	142	138	133	127	118	114	109	97	91	84	71
SX 617-15	12,5	9,3	169	163	159	154	146	137	131	125	112	105	97	82
SX 617-17	15	11	192	185	181	174	166	155	149	142	127	119	110	92
SX 617-18	15	11	203	196	191	184	175	164	157	150	134	126	117	98
SX 617-20	15	11	226	218	212	205	195	182	175	167	149	140	130	109
SX 617-24	20	15	271	262	255	246	234	219	210	201	179	168	156	131
SX 617-27	20	15	305	294	287	277	263	246	236	226	202	189	175	147
SX 617-29	25	18,5	327	316	308	297	283	264	254	242	217	203	188	158
SX 617-33	25	18,5	372	360	351	338	321	301	289	276	247	231	214	180
SX 617-36	30	22	406	392	382	369	351	328	315	301	269	252	234	196
SX 617-40	30	22	451	436	425	410	390	365	350	334	299	280	260	218
SX 617-48	35	26	542	523	510	492	468	437	420	401	359	336	312	261
SX 617-53	40	30	598	578	563	543	516	483	463	443	396	371	344	288
SX 617-5	50	37	621	599	584	563	536	501	481	460	411	385	357	299

Ø Impulsión: 2 1/2" - Outlet Ø: 2 1/2"

Tipo Type	Potencia		Caudal m ³ /h / Flow m ³ /h											
	HP	KW	0	10,8	14,4	18	21,6	25,2	27	28,8	32,4	36	39,6	43,2
			Altura m.c.a. / Height w.c.m.											
SX 630-04	5,5	4	45	42	41	39	37	34	33	31	27	23	17	11
SX 630-06	7,5	5,5	68	64	61	59	55	51	49	47	41	34	26	17
SX 630-08	10	7,5	90	85	82	78	74	69	66	62	54	45	35	23
SX 630-11	12,5	9,3	124	117	113	108	102	94	90	85	75	62	48	32
SX 630-13	15	11	147	138	133	127	120	111	106	101	88	75	57	37
SX 630-15	17,5	13	170	159	154	147	139	129	123	116	102	85	66	43
SX 630-17	20	15	192	180	174	167	157	146	139	132	115	96	74	49
SX 630-19	25	18,5	215	202	195	186	176	163	156	147	129	107	83	54
SX 630-21	25	18,5	237	223	215	206	194	180	172	163	143	119	92	60
SX 630-23	30	22	260	244	236	225	213	197	188	178	156	130	101	66
SX 630-26	30	22	294	276	266	255	240	223	213	202	177	147	114	74
SX 630-28	35	26	316	297	287	274	259	240	229	217	190	158	122	80
SX 630-30	35	26	339	318	307	294	277	257	246	233	204	170	131	86
SX 630-32	40	30	362	340	328	314	296	274	262	248	217	181	140	92
SX 630-35	40	30	396	371	359	343	324	300	287	271	238	198	153	100
SX 630-39	50	37	441	414	400	382	361	334	319	302	265	221	170	112
SX 630-43	50	37	486	456	441	422	398	368	352	333	292	243	188	123

Ø Impulsión: 3" - Outlet Ø: 3"

SX semi-axiales

Tipo Type	Potencia		Caudal m ³ /h / Flow m ³ /h											
	HP	KW	0	18,9	21,6	27	32,4	37,8	43,2	48,6	54	59,4	62,1	64,8
			Altura m.c.a. / Height w.c.m.											
SX 646-03	7,5	5,5	46	40	38	35	32	30	28	25	22	17	13	9
SX 646-05	10	7,5	77	66	64	59	54	50	46	42	37	28	22	15
SX 646-06	12,5	9,3	92	80	76	70	65	60	56	50	44	33	27	18
SX 646-07	15	11	107	93	89	82	76	70	65	59	51	39	31	21
SX 646-08	17,5	13	122	106	102	94	87	80	74	67	58	44	35	24
SX 646-09	20	15	138	119	115	106	97	90	83	76	66	50	40	27
SX 646-10	20	15	153	133	127	117	108	100	93	84	73	56	44	30
SX 646-11	25	18,5	168	146	140	129	119	110	102	93	80	61	49	32
SX 646-12	25	18,5	184	159	153	141	130	120	111	101	88	67	53	35
SX 646-14	30	22	214	186	178	164	151	140	130	118	102	78	62	41
SX 646-15	30	22	230	199	191	176	162	150	139	126	110	83	67	44
SX 646-16	35	27	245	212	204	188	173	160	148	135	117	89	71	47
SX 646-17	35	27	260	266	217	200	184	170	157	143	124	94	75	50
SX 646-18	40	30	276	239	229	211	195	180	167	151	131	100	80	53
SX 646-20	40	30	306	265	255	235	216	200	185	168	146	111	89	59
SX 646-22	50	37	337	292	280	258	238	220	204	185	161	122	98	65
SX 646-24	50	37	367	318	306	282	260	240	222	202	175	133	106	71

Ø Impulsión: 4" - Outlet Ø: 4"

Tipo Type	Potencia		Caudal m ³ /h / Flow m ³ /h											
	HP	KW	0	18	21,6	28,8	36	43,2	50,4	54	57,6	61,2	64,8	72
			Altura m.c.a. / Height w.c.m.											
SX 660-02	5,5	4	27	25	24	23	21	19	18	17	16	15	13	9
SX 660-03	7,5	5,5	41	38	37	34	31	29	27	25	24	22	20	14
SX 660-04	10	7,5	55	51	49	45	42	39	36	34	32	29	26	18
SX 660-05	12,5	9,3	68	63	61	57	52	48	44	42	40	37	33	23
SX 660-06	15	11	82	76	73	68	63	58	53	51	47	44	39	27
SX 660-07	17,5	13	95	88	86	79	73	68	62	59	55	51	46	32
SX 660-08	20	15	109	101	98	91	84	78	71	67	63	58	52	36
SX 660-09	25	18,5	123	114	110	102	94	87	80	76	71	66	59	41
SX 660-10	25	18,5	136	126	122	113	105	97	89	84	79	73	66	45
SX 660-11	30	22	150	139	134	125	115	107	98	93	87	80	72	50
SX 660-12	30	22	164	152	147	136	126	116	107	101	95	88	79	54
SX 660-13	35	26	177	164	159	147	136	126	116	110	103	95	85	59
SX 660-15	40	30	205	189	183	170	157	145	133	127	119	110	98	68
SX 660-17	40	30	232	215	208	193	178	165	151	143	135	124	112	77
SX 660-18	50	37	246	227	220	204	189	175	160	152	142	132	118	81
SX 660-19	50	37	259	240	232	215	199	184	169	160	150	139	125	86
SX 660-20	50	37	273	253	244	227	210	194	178	169	158	146	131	90
SX 660-21	50	37	286	265	257	238	220	204	187	177	166	154	138	95

Ø Impulsión: 4" - Outlet Ø: 4"

SX semi-axiales

Tipo Type	Potencia		Caudal m ³ /h / Flow m ³ /h								
	HP	KW	0	20	40	60	70	80	90	100	110
			Altura m.c.a. / Height w.c.m.								
SX 896-01	7,5	5,5	25	24	21	19	18	17	16	15	13
SX 896-02	15	11	49	46	41	36	34	33	32	28	25
SX 896-03	20	15	74	70	62	55	52	50	47	43	37
SX 896-04	30	22	98	93	82	74	70	66	63	57	50
SX 896-05	40	30	123	117	103	91	87	82	77	72	62
SX 896-06	50	37	147	139	123	110	104	99	93	86	74
SX 896-07	50	37	172	163	145	128	122	116	109	100	87
SX 896-08	60	45	196	186	166	146	139	132	124	115	99
SX 896-09	60	45	221	210	186	165	156	149	140	128	112
SX 896-10	75	55	245	232	207	183	173	165	156	143	124
SX 896-11	80	60	270	256	227	201	191	181	172	158	136
SX 896-12	90	67	294	279	248	220	209	198	187	172	149
SX 896-13	100	75	319	303	269	238	225	215	202	186	162
SX 896-14	100	75	343	325	289	256	243	231	218	200	173
SX 896-15	110	81	368	349	310	274	261	248	233	215	186
SX 896-17	125	92	417	396	351	311	295	280	265	243	211

Ø Impulsión: 5" - Outlet Ø: 5"

Tipo Type	Potencia		Caudal m ³ /h / Flow m ³ /h											
	HP	KW	0	36	58	72	94	101	108	115	130	144	158	173
			Altura m.c.a. / Height w.c.m.											
SX 10126-01	15	11	31	30	28	27	25	25	24	24	22	19	17	13
SX 10126-02	30	22	63	60	57	55	51	49	48	46	42	38	32	25
SX 10126-03	50	37	94	89	85	81	76	74	72	70	64	57	49	39
SX 10126-04	60	45	125	120	114	109	102	99	95	92	85	75	65	52
SX 10126-05	75	55	157	149	142	136	126	123	120	116	106	95	81	65
SX 10126-06	90	67	188	179	171	164	152	148	143	138	127	114	98	77
SX 10126-07	100	75	221	209	189	191	177	172	168	162	149	133	114	90
SX 10126-08	125	93	252	238	226	218	203	197	191	184	170	152	130	104
SX 10126-09	150	110	283	269	255	245	228	221	215	208	191	171	147	117
SX 10126-10	150	110	315	298	283	272	254	246	239	231	213	190	163	129
SX 10126-11	175	129	346	328	312	300	279	271	263	254	233	209	178	142
SX 10126-12	175	129	377	358	340	327	304	296	287	277	255	228	195	155
SX 10126-13	200	147	409	387	368	354	330	320	311	300	276	247	212	169

Ø Impulsión: 6" - Outlet Ø: 6"

SX semi-axiales

Tipo Type	Potencia		Caudal m ³ /h / Flow m ³ /h											
	HP	KW	0	36	54	72	90	108	126	144	162	180	198	216
			Altura m.c.a. / Height w.c.m.											
SX 10160-01	17,5	13	30	28	27	26	25	23	22	20	19	16	13	10
SX 10160-02B	25	19	46	44	42	40	38	36	34	31	29	25	21	15
SX 10160-02	35	27	60	57	55	52	49	47	44	41	37	33	27	19
SX 10160-03B	40	30	77	73	70	67	63	60	56	52	48	42	34	24
SX 10160-03	50	37	90	85	82	78	74	70	66	61	56	49	40	29
SX 10160-04	60	45	120	114	109	104	98	93	87	81	74	65	53	38
SX 10160-05	75	55	150	142	136	130	123	116	109	102	93	82	67	48
SX 10160-06B	80	60	162	154	147	140	133	126	118	110	100	88	72	51
SX 10160-06	90	67	180	171	164	156	148	140	131	122	111	98	80	57
SX 10160-07B	100	75	195	185	177	169	160	151	142	132	121	106	87	66
SX 10160-07	110	81	210	199	191	182	172	163	153	142	130	114	94	67
SX 10160-08	125	92	240	228	218	208	197	186	175	163	148	131	107	76
SX 10160-09	150	110	270	256	246	234	221	209	197	183	167	147	120	86
SX 10160-10	150	110	300	285	273	260	246	233	219	203	185	163	134	95
SX 10160-11	175	129	330	313	300	286	271	256	240	224	204	180	147	105
SX 10160-12	200	147	360	342	327	312	295	279	262	244	222	196	160	114
SX 10160-13	200	147	390	370	355	338	320	302	284	264	241	212	174	124

Ø Impulsión: 6" - Outlet Ø: 6"

Tipo Type	Potencia		Caudal m ³ /h / Flow m ³ /h								
	HP	KW	0	100	140	180	200	220	240	260	290
			Altura m.c.a. / Height w.c.m.								
SX 10210-01B	20	15	28	25	22	20	19	18	16	15	11
SX 10210-01	25	18,5	38	32	29	26	25	23	22	19	15
SX 10210-02B2	40	30	57	48	43	39	37	34	31	28	23
SX 10210-02	50	37	75	65	58	52	49	46	42	38	30
SX 10210-03B3	60	45	91	77	70	63	59	55	51	46	36
SX 10210-03	75	55	114	97	87	78	74	69	64	57	45
SX 10210-04B2	90	67	133	113	102	91	86	80	74	67	53
SX 10210-04	100	75	152	128	117	104	98	92	85	76	60
SX 10210-05	125	92	190	161	145	130	123	115	106	95	74
SX 10210-06	150	110	227	193	174	157	147	138	127	115	90
SX 10210-07	175	129	266	225	204	182	172	161	148	133	105
SX 10210-08	200	150	304	258	232	209	197	184	170	153	120
SX 10210-09	225	166	342	290	262	234	221	207	191	172	135
SX 10210-10	250	185	379	322	291	261	246	230	212	191	150

Ø Impulsión: 6" - Outlet Ø: 6"

FR

motores sumergibles 4", 6", 8" y 10"



Aplicaciones:

Motores eléctricos FR para bombas sumergibles con acoplamiento de 4" y también de 6", 8" y 10".

Los motores de 4" contienen en su interior un baño de aceite líquido dieléctrico atóxico, apto para instalaciones de todo tipo, y especialmente indicado en instalaciones con tensión de red baja, y en instalaciones de depósito abierto, gracias a su fácil refrigeración. Disponen además de un diafragma que permite la compensación de la presión interior del motor con la del pozo.

Los motores de 6", 8" y 10" son todos rebobinables, y disponen de cojinetes radiales y axiales de doble sentido de giro lubricados por agua.

Características constructivas:

- **Completamente en AISI-304 (4" - 6" - 8") y con tapa en fundición de hierro (10")**
- **Estator rebobinable.**
- **Acoplamiento standard NEMA.**
- Cable de alimentación con conector estanco.
- Máximo número de arranques: 40 arranques/hora (motores de 4").
- Inmersión máxima: 200 metros bajo el agua (motores de 4").
- Protección IP68, aislamiento clase F.
- Máxima temperatura del agua: 35° C.

Bajo pedido puede suministrarse con con ánodo de sacrificio.



Applications:

Electrical motors FR type for submersible pumps with 4", and 6", 8" and 10" with NEMA coupling.

The 4" motors are filled with non toxic dielectric oil. This motor is suitable for all types of applications and specially recommended in installations with low net tension, and in tank pools, thanks to its easy cooling avility.

The 6", 8" and 10" motors are all rewindable, and equipped with radial and axial bearings of dual rotation, and water lubricated.

Constructive characteristics:

- **Completely in AISI-304 (4" - 6" - 8") and with cast iron cover (10")**
- **Rewindable stator**
- **Standard NEMA coupling**
- Wire with resin filled connector
- Maximum number of starts: 40 per hour (only 4" motors)
- Maximum immersion: 200 meters under the water (only 4" motors)
- Protection IP68, Isolation class F
- Maximum water temperature: 35°C

Can be supplied with sacrificial anode on demand.

FRANKLIN



Aplicaciones:

Motores blindados fabricados según normas ISO 9001 en baño de agua, totalmente en acero inoxidable AISI-304 y con acoplamiento para bomba de tipo NEMA. Los motores de 4" monofásicos necesitan de condensador exterior.

Todos los motores se suministran con uno o dos tramos de cable en función del tipo de arranque del motor.

Características constructivas:

Estátor encapsulado o rebobinable

Retén mecánico y protector para un mejor funcionamiento contra la arena.

Permite montaje tanto vertical como horizontal.

Motores de 6", 8" y 10" pueden solicitarse para arranque directo o para arranque estrella-triángulo

Motor:

Motores de 4" encapsulados monofásicos (hasta 3CV) y trifásicos a 230V (hasta 7.5CV) ó 400V (hasta 10CV)

Motores de 6" encapsulados (hasta 60CV) o rebobinables (hasta 45CV)

Motores de 8" encapsulados (hasta 200CV) o rebobinables (hasta 125CV)

Motores de 10" rebobinables (hasta 250CV)

Bajo demanda pueden solicitarse voltajes especiales y/o constructivamente en AISI-316.



Applications:

Hermetic motors manufactured complying with DIN and ISO 9001 standards. Filled international NEMA coupling. Fully made in stainless steel 304. The 4" single phase motors require external capacitor.

All motors are supplied with one or two wires depending on the start mode.

Constructive characteristics:

Encapsulated or rewindable stator.

Seal and protector for a better performance against sand.

Horizontal and vertical installation.

Motors from 6" to 10" can be supplied direct start or star delta.



Motor:

Motors 4" encapsulated single phase (up to 3HP)

- Three phase 230V up to 7.5HP

- Three phase 230V up to 10HP

Motors 6" encapsulated up to 60HP and rewindable up to 45HP

Motors 8" encapsulated up to 200HP and rewindable up to 125HP

Motors 10" rewindable up to 250HP

On request, special voltages can be requested and / or constructively in AISI-316.

VORT

aguas fecales vórtex
vortex fecal water



Aplicaciones:

Bomba centrífuga sumergible idónea para el desagüe de aguas sucias y cargadas en general. Incorporan interruptor de nivel para su funcionamiento automático en versión monofásica.

Características constructivas:

Cuerpo bomba, cuerpo motor, turbina y eje motor en acero inoxidable AISI-304. Doble sello mecánico y cámara intermedia de aceite atóxico. Equipada con 10 metros de cable.

Motor:

A 2.850 r.p.m., asíncrono estanco con aislamiento clase F=155° C. y grado de protección IP-68, la refrigeración del motor se efectúa por el líquido en el cual está sumergida. Inmersión máxima 10 metros.



Applications:

Submersible centrifugal pump in stainless steel that is ideal for draining dirty waters and waters that are generally loaded.

Constructive characteristics:

Pump body, mechanical closing lid, filter, filter lid, shaft, motor housing, external housing and lid with handle in AISI 304 stainless steel.

Vortex Impeller in AISI 304 microfusion stainless steel
Double mechanical seal with intermediate oil chamber.

Motor:

At 2,850 r.p.m., asynchronous closed with isolation type F (155 ° C) IP-68 protection. Refrigeration of the motor through the liquid surrounding.

Maximum immersion 10 meters.

Tipo Type	Potencia		"A"		Altura m.c.a. / Height w.c.m.										Ø Paso Sólido	Ø Imp.
	HP	KW	II 230	III 400	2	4	5	6	7	8	9	10	11			
					Caudal m ³ /h / Flow m ³ /h											
VORT 7 M Aut	0,75	0,55	4,2	-	15	11	9	7,5	5	2,5					35	1 1/2"
VORT 10 M Aut	1	0,75	5,1	-	26	21	16	14	8	0,5					50	2"
VORT 15 M Aut	1,5	1,1	8,3	-	26	22	20	16	11	1					50	2"
VORT 15 T			-	2,8												
VORT 20 T	2	1,5	-	3,6	32	29	27	24	20	16	10	1		50	2"	

COMPACTA

aguas fecales vórtex
vortex fecal water



Aplicaciones:

Las robustas y portátiles electrobombas de la serie compacta que incorporan turbina desplazada tipo Vortex están diseñadas específicamente para la evacuación de aguas cargadas que contengan gases o bien sólidos blandos en suspensión. Son ideales para su uso en fosas sépticas, industrias, hospitales, etc... Debe trabajar con el motor, al menos, parcialmente sumergido.

Características constructivas:

Cuerpo bomba, carcasa motor, porta cojinetes y tapa motor en fundición de hierro GG25. Tornillería en acero inoxidable tipo A2. Juntas tóricas en nitrilo. Eje bomba en acero inoxidable AISI 420. Doble sello mecánico en cámara de aceite, de carbón-cerámica en el lado de motor, y de carburo de silicio en la parte de la turbina.

Motor:

Asíncrono a 2.850 r.p.m. monofásico y trifásico, aislamiento clase F. Grado de protección IP-68 e incorpora motoprotector en el bobinado en las versiones monofásicas. Incorpora serie 10 mts. de cable H07 RNF. Temperatura máxima del agua en continuo + 40° C. Valores de Ph entre 6 y 11.

Applications:

The robust, portable electropumps of the compact series that include a displaced Vortex type Impeller are specifically designed for evacuating loaded waters that contain soft solids in suspension. They are ideal for use in septic tanks, industries, hospitals, etc... Must work with motor partially immersed.

Constructive characteristics:

Pump body, motor housing, bearing holder and motor lid in GG25 cast iron. Bolts in A2 stainless steel. O-rings in nitril. Pump shaft in AISI 420 stainless steel. Double mechanical seal in oil chamber, carbon-ceramic on the motor side and silicon carbide on the impeller side.

Motor:

Asynchronous at 2,850 rpm, single and triple phase, class F insulation. IP-68 protection. Includes 10 metres of HO7 RNF cable as standard. Maximum water temperature in continuous + 40° C. Ph values between 6 and 11.

Tipo Type	Con. µF	Volt.	Potencia		"A"		Altura m.c.a. / Height w.c.m.										Ø Paso Sólido	Ø Imp.	
			HP	KW	II 230	III 400	2	4	5	6	8	10	12	14	16	18			
							Caudal m³/h / Flow m³/h												
COMPACTA 1 M Aut.	7,5	230M	0,4	0,28	1,9	-	7,7	4,5	3,2	1,8								30	1 1/4"
COMPACTA 2 M Aut.	16	230M	0,75	0,55	3,6	-	12,8	10	8,4	6,7	3,1							35	1 1/2"
COMPACTA 2 T	-	400T			-	1,8													
COMPACTA 3 M Aut.	20	230M	1	0,75	5,2	-	16,5	13,5	12	10,7	7,2	3,5						35	1 1/2"
COMPACTA 3 T	-	400T			-	2,0													
COMPACTA 22 M Aut.	16	230M	0,75	0,55	3,6	-	24,1	18,2	14,5	10,5	2							40	2"
COMPACTA 22 T	-	400T			-	1,8													
COMPACTA 32 M Aut.	20	230M	1	0,75	5,2	-	29	23,5	20	16,5	9,5	2						40	2"
COMPACTA 32 T	-	400T			-	2,0													
COMPACTA 4 M Aut.	30	230M	1,5	1,1	7,6	-		27	24	21	16	9	3					50	2"
COMPACTA 4 T	-	400T			-	2,9													
COMPACTA 55 M Aut	32	230M	2	1,5	9,9	-		30	27	25,5	20	15	9	3				50	2"
COMPACTA 55 T	-	400T			-	3,7													
COMPACTA 6 T	-	400T	3	2,2	-	5,2		37	36	34	29	24	19	14	7,2	0,5		50	2"

VG

aguas fecales vórtex
vortex fecal water



Aplicaciones:

Bomba centrífuga sumergible idónea para el desagüe de aguas sucias y cargadas en general. Incorporan interruptor de nivel para su funcionamiento automático en versiones monofásicas.

Características constructivas:

Cuerpo impulsión, tapa superior motor y turbina en fundición de hierro. Eje bomba y camisa en acero inoxidable AISI-304. Dispone de doble sello mecánico con cámara intermedia de aceite atóxico. Equipada con 10 metros de cable eléctrico de tipo H07RN-F.

Motor:

Motor en seco, refrigerado por el medio líquido en el que está sumergida la bomba. Versiones monofásicas incorporan una protección termo amperimétrica. Temperatura del líquido: +0°C a +40° C. Aislamiento Clase F.



Applications:

Submersible centrifugal pump with stainless steel sleeve that is ideal for draining dirty waters and waters that are generally loaded.



Constructive characteristics:

Pump body, upper motor cover and impeller in cast iron. Pump shaft and sleeve in stainless steel AISI-304. Double mechanical seal with intermediate oil chamber. Includes 10 meters of H07RN-F cable.

Motor:

Dry motor, cooled by the liquid medium in which the pump is submerged. Single phase pumps includes a thermal protection. Temperature of the liquid: from + 0°C to +40°C. Issolation Class F.

Tipo Type	Cond. µF	Potencia		"A"		Altura m.c.a. / Height w.c.m.										Paso Solido mm.	Ø Imp.
		HP	KW	II 230	III 400	3	4,5	6	9	12	15	18	21	24			
Caudal m³/h / Flow m³/h																	
VG 05 M Aut	12	0,5	0,37	3,5	-	15	12,5	9	2,5	-	-	-	-	-	35	2"	
VG 10 M Aut	20	1	0,75	5,0	-	20	18	15,5	10,5	4	-	-	-	-	35	2"	
VG 10 T	-			-	1,9												
VG 20 M Aut	40	2	1,5	9,6	-	40	36	32	25	17,5	5	-	-	-	50	2"	
VG 20 T	-			-	3,6												
VG 30 T	-	3	2,2	-	4,8	50	46	42,5	36	30	22	8	-	-	50	2"	
VG 50 T	-	5	3,7	-	7,9	60	57,5	54	51	44	37	30	18	4	50	3"	

GRIX/GT/GX



Tipo Type	P2 (HP)	"A"		r.p.m.	Altura m.c.a. / Height w.c.m.							
		II 230	III 400		5	6	7	8	9	10	12	
Caudal m ³ /h / Flow m ³ /h												
GRIX 32-2 90 M Aut	1,2	5	-	2.850	9	8,8	8,5	8	7,7	7,2	6,2	
GRIX 32-2 90 T		-	2,1	2.850								
GRIX 32-2 110 M Aut	1,5	7	-	2.850	10,6	10,5	10,4	10,2	9,9	9,6	8,8	
GRIX 32-2 110 T		-	2,9	2.850								
GX 50-2 220 T	3	-	5	2.850	21,5	21	20,5	20	19,5	18,7	17,5	
GT 50-2 165 T	4,5	-	6,9	2.850								
GT 50-2 170 T	6	-	8,9	2.850								
GT 50-2 175 T	8,5	-	12,4	2.850								
GT 50-2 180 T	10,5	-	16,2	2.850								
GT 50-2 185 T	13	-	20	2.850								



Aplicaciones:

Bomba de tipo sumergible con triturador, para el servicio civil e industrial, de bombeado de aguas sucias procedentes de servicios higiénicos en albergues, campamentos, hospitales y de aguas residuales procedentes del zoo, industria conservera, etc.

En caso de trabajar a baja altura, recomendamos instalar una válvula de bola para provocar el trabajo dentro de la curva.

Características constructivas:

Cuerpo bomba, cuerpo motor y turbina en fundición de alta resistencia. Dispositivo triturador en acero inoxidable obtenido por microfundición y endurecido para obtener dureza y tenacidad. Disco cierre de hierro. Tornillería y extensión eje motor en acero inoxidable. Cierre mecánico en carburo de silicio.

Motor:

Asíncrono absolutamente estanco con aislamiento clase F= 155° C. y grado de protección IP-68, la refrigeración del motor efectua por el líquido en el cual está sumergida la bomba. **Instalar siempre una válvula de corte para ajustar la altura manométrica mínima de la bomba.**



Applications:

Submersible pumps with grinder cutting system for civil and industrial use. To pump waters from sanitary services in boarding houses, camp sites, hospitals, and residual waters from zoos, conserve industries, etc...

Esphere valve recomeded for low pressure work.

Constructive characteristics:

Body, motor housing and Impeller in high strength cast iron. Grinder mechanism in stainless steel obtained by microfusion and hardened to achieve hardn ess and tenacity. Iron sealing disk. Bolts and motor shaft extension in stainless steel. Mechanical seal chamber in silicon carbide.

Motor:

Submersible, asynchronous, continuous service, tight seal cladded. Rotor mounted with ball bearings calculated to guarantee duration and silent working. CEI standard. IP-68 protection. F insulation.

Control containing the permanent capacitor and the mechanism for increasing the starting torque.

Install always a closing valve to adjust the minimum manometric high of each pump.

Altura m.c.a. / Height w.c.m.																	Paso solidos Free Pass mm.	Ø IMP. Outlet
14	16	18	20	23	26	29	32	35	38	41	44	47	50	56	62			
Caudal m³/h / Flow m³/h																		
5	3,9	2,7	1,4														6	1 1/4"
7,7	6,7	5,5	4,4	2,2													6	1 1/4"
16	14,4	12,3	10,5	7,5	4,5	1,3											6	2"
	19,5	19	18,5	15,4	11,5	7,5	4,2	0,5									8	2"
		21,5	21	19,8	18	14	10,8	7,2	3,5								8	2"
				28	25,2	21,7	18	14	11	6,5	3						10	DN 50
						28,5	28	26	24	17,5	15	11	7,2				10	DN 50
									28,5	28	27	24	20	12,5	5	10	10	DN 50

HT

aguas cargadas a grandes alturas
laden waters at high altitudes



Aplicaciones:

Las electrobombas de la serie HT están especialmente diseñadas para la elevación de aguas claras y ligeramente cargadas o arenosas a grandes alturas. Especialmente indicadas para fuentes, riegos, pozos, cisternas, etc...

Características constructivas:

Carcasa, tapa motor, cuerpo bomba y turbina en fundición G-25 de alta resistencia; eje rotor y tornillería en inox.; juntas tóricas en goma nitrílica; cierre mecánico autolubricado mediante cámara intermedia de aceite, cierre mecánico superior en cerámica-grafito y cierre mecánico inferior en carburo de silicio-vitón.

Motor:

Asíncrono, en baño de aceite dieléctrico y atóxico, absolutamente estanco con aislamiento tipo F=155° C y grado de protección IP-68; de serie con 10 mts. de cable de neopreno H07-RN-F. Todos los motores de esta serie son a 2.850 r.p.m. Temperatura máxima del agua bombeado en continuo + 40° C y en intermitente + 80° C. Valores Ph: entre 6-11. Profundidad máxima de inmersión: 20 mts. Densidad máxima del líquido: 1.100 Kg/ m³



Applications:

The electropumps of the HT series are especially designed to raise clear and lightly loaded or sandy waters to great heights. Particularly recommended for fountains, irrigation, wells, cisterns, etc...



Constructive characteristics:

Housing, motor lid, pump body and Impeller in G-25 high strength cast iron; rotor shaft and bolt work in stainless steel, o-rings in nitril rubber, mechanical seal self-lubricated by intermediate oil chamber, upper mechanical seal in graphite ceramic and lower in silicon carbide - viton.

Motor:

Asynchronous, in dielectric and atoxic oil bath only in the seal chamber, absolutely sealed with F=155° C sealing and IP-68 protection. Standard with 10 metres of H07-RN-F neoprene cable. All motors are standard at 2,850 rpm. Maximum water temperature pumped in continuous + 40° C and in intermittent + 80° C. Ph values: between 6-11. Maximum immersion: 20 metres. Maximum density of the liquid: 1.100 Kg/ m³

Tipo Type	Potencia		"A"	Altura m.c.a. / Height w.c.m.														Paso solidos Free Pass mm.	Ø IMP. Outlet		
	HP	KW		III 400	4	6	10	14	16	18	20	22	24	26	30	34	38			42	46
	Caudal m³/h / Flow m³/h																				
HT 50-2 C. 500	2	1,5	3,8	27	24	17	10	6,8	3,6											17	2"
HT 50-2 C. 501	3	2,2	5,2	31	29	25	19	16	13	10	6,8	3								17	2"
HT 65-2 C. 502	4	3	7,5	33	31	26	21	19	16	13	10	7	5							10	DN 65 / PN 6
HT 65-2 C. 503	5,5	4	9,4	38	37	33	30	28	26	24	22	19	16	12	6	1				10	DN 65 / PN 6
HT 65-2 C. 504	7,5	5,5	12,5	53	51	46	41	38	36	34	32	28	26	19	13	7				10	DN 65 / PN 6
HT 65-2 C. 505	10	7,5	15,5	65	64	59	54	53	50	49	45	42	40	34	28	20	15	7,2	1	10	DN 65 / PN 6

M

turbina monocanal single channel impeller



Aplicaciones:

Las electrobombas de la serie M, por su robustez y diseño compacto, son las idóneas para el bombeado de aguas residuales como pueden ser fangos biológicos, etc., que contengan sólidos en suspensión. Especialmente indicadas para el sector civil, industrial y sanitario. Gracias al diseño de sus diferentes componentes así como a los dispositivos de seguridad que incorporan los motores, estas bombas son aptas para un trabajo continuo.

Debe trabajar con el motor completamente sumergido.

MÁXIMA TEMPERATURA DEL LÍQUIDO: 50° C

Características constructivas:

Carcasa, tapa motor, cuerpo bomba y turbina en fundición G-25 de alta resistencia; eje rotor y tornillería en inox.; juntas tóricas en goma nitrílica; cierre mecánico superior en cerámica-grafito y cierre mecánico inferior en carburo de silicio-vitón. Todas las bombas incluyen cámara de aceite atóxico y sensores de temperatura en el bobinado del motor.

Motor:

Asíncrono, absolutamente estanco con aislamiento tipo F=155° C y grado de protección IP-68; de serie con 10 mts. de cable de neopreno HO7-RN-F. La refrigeración del motor se efectúa por el líquido en el cual está sumergida la bomba.



Applications:

The robustness and compact design of the electro-pumps of the M series make them ideal for pumping waste waters such as biological silts, etc. that contain solids in suspension of up to 140 x 140 mm. Particularly recommended for the civil, industrial and sanitary sectors. Thanks to the design of the open monochannel, multichannel Impellers,

The upper part of the Impeller includes a toothed section that prevents particles and filaments from adhering to the shaft.

Must work with motor fully submerged.

MAXIMUM TEMPERATURE OF THE LIQUID: 50° C

Constructive characteristics:

Housing, motor lid, pump body and Impeller in G-25 high strength cast iron; rotor shaft and bolt work in stainless steel, o-rings in nitril rubber, mechanical seal self-lubricated by intermediate oil chamber, upper mechanical seal in graphite ceramic and lower in silicon carbide - viton. All pumps include a non-toxic oil chamber and temperature sensors in the motor winding.

Motor:

Asynchronous, class F=155° C insulation and IP-68 protection. Standard with 10 metres of HO7-RN-F neoprene cable. These pumps works 2,850 rpm - 1,450 rpm - 970 rpm.



Zócalo de anclaje bajo demanda

Pedestal kit under demand

M

Tipo Type	P2 (HP)	"A"	r.p.m.	Altura m.c.a. / Height w.c.m.										
				2	3	4	5	6	7	8	9	10	12	14
				Caudal m ³ /h / Flow m ³ /h										

MONOCANAL 2.850 r.p.m.

M 65/2 C. 236	2	3,8	2850	49	47	44	42	39,5	37	34,3	32	29	23	16,5
M 65/2 C. 237	3	5,3	2850	62	59	57	54	52	49	46	44	41	35,5	31
M 65/2 C. 247	5,5	9,4	2850	79	77	74	71	68,5	66	62,5	60	56	50	43
M 80/2 C. 254	7,5	11,5	2850			124	118	114	110	107	102	98	89	79
M 80/2 C. 257	10	14,1	2850			140	136	132	128	124	120	116	108	98
M 80/2 C. 267	16	23	2850				195	190	185	180	175	170	163	150
M 80/2 C. 268	20	29,7	2850						225	220	216	212	204	195
M 80/2 C. 269	27	41,5	2850											
M 80/2 C. 270	34	48,4	2850											
M 80/2 C. 271	41	54,9	2850											

MONOCANAL 1.450 r.p.m.

M 80/4 C. 242	2	3,8	1450	94	82	70	58	44	35	24	7			
M 80/4 C. 244	3	5,3	1450	112	101	92	81	70	60	49	39	24	4	
M 80/4 C. 245	4	7,2	1450	130	120	112	103	92	84	75	63	54	34	15
M 100/4 C. 243	2,2	3,9	1450	93	82	72	63	49	38	27	16	7		
M 100/4 C. 244	3	5,1	1450	108	99	90	80	69	60	49	37	28	8	
M 100/4 C. 245	4	7	1450	126	119	108	98	88	78	68	58	47	27	11
M 100/4 C. 255	5,5	9,2	1450	150	140	130	120	109	98	88	78	67	46	25
M 100/4 C. 256	7,5	11,5	1450		165	158	148	138	127	117	108	98	76	57
M 150/4 C. 258	10	15,6	1450		274	261	245	230	212	199	180	162	126	87
M 150/4 C. 260	13,5	21,3	1450			226	221	218	210	203	192	188	170	143
M 150/4 C. 263	22,5	33,2	1450					259	256	252	248	245	234	219
M 150/4 C. 264	15	23,4	1450					330	288	270	242	225	208	122
M 150/4 C. 265	20	31,8	1450					362	342	324	310	295	277	240
M 150/4 C. 275	24	39,7	1450					415	404	390	378	360	345	310
M 150/4 C. 280	31	47,7	1450								421	405	392	363
M 150/4 C. 285	40	59	1450								508	495	477	460
M 150/4 C. 290	53,5	73,2	1450											523
M 150/4 C. 295	61	98,6	1450											500
M 150/4 C. 300	68	108,6	1450											

**Zócalo de anclaje
bajo demanda**

*Pedestal kit under
demand*



M

Altura m.c.a. / Height w.c.m.														Paso solidos Free Pass mm.	Ø IMP. Outlet
16	18	20	23	26	29	35	38	41	44	47	50	55	60		
Caudal m ³ /h / Flow m ³ /h															

																	40	DN 65 / PN10
	9,5	2															40	DN 65 / PN10
	24	18	12	2,5													45	DN 65 / PN10
	36	29	22	10													60	DN 80
	68	60	49	33	18	3											60	DN 80
	90	80	70	55	40	26											33	DN 80
	145	138	124	110	95	76	42	20	5								33	DN 80
	188	177	167	154	139	122	90	73	58	40	22						40	DN 80
			192	175	162	148	119	101	86	65	50	30					40	DN 80
			217	203	189	172	145	128	116	95	83	64	35				40	DN 80
			238	223	211	197	174	158	148	125	113	96	68	42			40	DN 80
																	75	DN 80
																	75	DN 80
																	75	DN 80
																	75	DN 100
																	75	DN 100
																	75	DN 100
	7																90	DN 100
	36	18															90	DN 100
	43																100	DN 150
	130	100	81	50	25												80	DN 150
	205	185	162	125	93	50											80	DN 150
	80	42															110	DN 150
	165	130	98	21													110	DN 150
	240	200	165	115	55												120	DN 150
	300	260	231	175	125	67											120	DN 150
	343	315	280	232	185	166	45										110	DN 150
	475	443	418	375	325	280	180	130	88	32							120	DN 150
		535	510	470	432	387	300	255	195	155	100	43					130	DN 150
							362	323	277	240	198	156	77				140	DN 150

VT

turbina vortex vortex impeller



Aplicaciones:

Las electrobombas de la serie VT, por su robustez y diseño compacto, son las idóneas para el bombeado de aguas residuales como pueden ser fangos biológicos, etc., que contengan sólidos en suspensión de hasta 130 x 130 mm. Especialmente indicadas para el sector civil, industrial y sanitario. Gracias al diseño de sus turbinas vortex es posible bombear líquidos que contengan gases la parte superior de la turbina incorpora un especial dentado que previene la adhesión de filamentos al eje y sello mecánico. **Debe trabajar con el motor completamente sumergido. TEMPERATURA MÁXIMA DEL LIQUIDO: 50° C**

Características constructivas:

Carcasa, tapa motor, cuerpo bomba y turbina en fundición G-25 de alta resistencia; eje rotor y tornillería en inox.; juntas tóricas en goma nitrílica; cierre mecánico superior en cerámica-grafito y cierre mecánico inferior en carburo de silicio-vitón. Todas las bombas incluyen cámara de aceite atóxico y sensores de temperatura en el bobinado del motor.

Motor:

Asíncrono, absolutamente estanco con aislamiento tipo

F=155° C y grado de protección IP-68; de serie con 10 mts. de cable de neopreno H07-RN-F. La refrigeración del motor se efectúa por el líquido en el cual esta sumergida la bomba.



Applications:

*The robustness and compact design of the electropumps of the VT series make them ideal for pumping waste waters such as biological silts, etc. that contain solids in suspension of up to 130 x 130 mm. Particularly recommended for the civil, industrial and sanitary sectors. Thanks to the design of the vortex Impellers, it is possible to transfer liquids with abrasive particles or gases. The upper part of the Impeller includes a toothed section that prevents particles and filaments from adhering to the shaft. **Must work with motor fully submerged. MAXIMUM TEMPERATURE OF THE LIQUID: 50° C***

Constructive characteristics:

Housing, motor lid, pump body and Impeller in G-25 high strength cast iron; rotor shaft and bolt work in stainless steel, o-rings in nitril rubber, mechanical seal self-lubricated by intermediate oil chamber, upper mechanical seal in graphite ceramic and lower in silicon carbide-viton. All pumps include a non-toxic oil chamber and temperature sensors in the motor winding.

Motor:

Asynchronous, in dielectric and atoxic oil bath only in the seal chamber, absolutely sealed with F=155° C sealing and IP-68 protection. Standard with 10 metres of H07-RN-F neoprene cable. All motors are standard at 2,850-1,450-970 rpm.

Tipo Type	P2 (HP)	"A"	r.p.m.	Altura m.c.a. / Height w.c.m.							
				2	3	4	5	6	7	8	
III 400				Caudal m³/h / Flow m³/h							
VORTEX 1.450 r.p.m.											
VT 80/4 C. 341	1,5	2,8	1450	54	44	32	20	7			
VT 80/4 C. 342	1,7	3,3	1450	68	57	47	36	25	13		
VT 80/4 C. 344	3	5,2	1450	102	90	77	66	54	42	28	
VT 80/4 C. 345	4	7,2	1450	116	107	96	85	74	63	53	
VT 100/4 C. 349	3	5,2	1450	98	80	63	46	28	13		
VT 100/4 C. 350	4	7,2	1450	118	103	86	73	62	45	33	
VT 100/4 C. 355	5,5	9,2	1450	132	123	110	98	85	73	57	
VT 100/4 C. 356	8	12,4	1450	145	137	128	122	111	100	91	
VT 100/4 C. 358	10	15,7	1450	166	158	152	144	136	128	122	
VT 100/4 C. 362	16	23,8	1450							163	
VT 100/4 C. 363	21	30,4	1450							97	
VT 100/4 C. 375	27	41	1450								
VT 100/4 C. 380	34	50,9	1450								
VT 150/4 C. 385	48	68	1450							410	
VT 150/4 C. 390	60	82,5	1450								
VT 150/4 C. 395	75	100,1	1450								



SUBMERSIBLE

VT

Altura m.c.a. / Height w.c.m.														Paso solidos Free Pass mm.	Ø IMP. Outlet	
9	10	12	14	16	18	20	23	26	29	32	35	38				
Caudal m ³ /h / Flow m ³ /h																
															75	DN 80
															75	DN 80
	16	7													80	DN 80
	42	30	7												80	DN 80
															100	DN 100
	18	3													100	DN 100
	45	32													90	DN 100
	83	72	50	28	5										90	DN 100
	110	102	78	63	39	15									90	DN 100
	155	150	140	108	86	43	18								100	DN 100
	195	194	176	157	136	101	85	35							100	DN 100
							144	115	83	40					100	DN 100
							194	157	120	78	46				100	DN 100
	373	342	288	243	190	145	90								130	DN 150
		470	414	368	324	280	236	175	108						130	DN 150
						442	386	311	256	198	134	50			130	DN 150

VN

vortex AISI-316



Aplicaciones:

Bomba centrífuga sumergible idónea para vaciado de depósitos con aguas agresivas, desagüe de aguas sucias y cargadas en general. Incorporan interruptor de nivel para su funcionamiento automático en versiones monofásicas.

Características constructivas:

Cuerpo impulsión, tapa superior motor, turbina, eje bomba y camisa exterior en acero inoxidable AISI-316. Dispone de doble sello mecánico con cámara intermedia de aceite atóxico. Equipada con 10 metros de cable eléctrico de tipo H07RN-F.

Motor:

Motor en seco, refrigerado por el medio líquido en el que está sumergida la bomba.

Versiones monofásicas incorporan una protección termo amperimétrica. Temperatura del líquido: +0°C a +40° C. Aislamiento Clase F.



Applications:

Submersible centrifugal pump ideal for emptying tanks with aggressive waters, draining dirty waters and waters that are generally loaded.

Constructive characteristics:

Pump body, upper motor cover, impeller, pump shaft and external sleeve in stainless steel AISI-316. Double mechanical seal with intermediate oil chamber. Includes 10 meters of H07RN-F cable.

Motor:

Dry motor, cooled by the liquid medium in which the pump is submerged.

Single phase pumps includes a thermal protection.

Temperature of the liquid: from + 0°C to +40°C.

Insulation Class F.

Tipo Type	Cond. µF	Potencia		"A"		Altura m.c.a. / Height w.c.m.										Paso Solido mm.	Ø Imp.
		HP	KW	II 230	III 400	3	4,5	6	9	12	15	18	24	27			
						Caudal m³/h / Flow m³/h											
VN 05 M Aut	12	0,5	0,37	3,5	-	15	12,5	9	2,5	-	-	-	-	-	35	2"	
VN 10 M Aut	20	1	0,75	5,0	-	20	18	15,5	10,5	4	-	-	-	-	35	2"	
VN 30 T-50	-	3	2,2	-	4,8	50	46	42,5	36	30	22	8	-	-	50	2"	
VN 50 T-80	-	5	3,7	-	7,9	60	57,5	54	51	44	37	30	4	-	50	3"	
VN 75 T-80	-	7,5	5,5	-	11,8	-	-	-	72	66	54	41	18	5	50	3"	

ESTACIONES DE BOMBEO

estaciones automáticas de recogida y elevación de aguas fecales
automatic waste water collection and lifting stations



Descripción: Estaciones automáticas para almacenamiento y elevación de aguas residuales civiles e industriales hacia el alcantarillado. Incluyen un depósito de polietileno de alta densidad de 110 lts. / 200 lts. y con los siguientes accesorios según modelo: **Estas estaciones de bombeo no incluyen bombas.**

KIT FEKABOX 110: (Para 1 sola bomba) incluye: Depósito 110 lts., 1 minizócalo de anclaje ya instalado. Puede usarse con las siguientes bombas: NOVA/FEKA y COMPACTA 1-2-3-22-32. Medidas: AxBxH / 700x380x500 mm.

KIT FEKABOX 200: (Para 1 sola bomba) incluye: Depósito 200 lts., 1 minizócalo de anclaje ya instalado. Puede usarse con las siguientes bombas: FEKA 600 y COMPACTA. Medidas: AxBxH / 850x555x735 mm.

KIT FEKAFOS 280: (Para 1 sola bomba) incluye: Depósito 280 lts., 1 minizócalo de anclaje ya instalado. Puede usarse con las siguientes bombas: COMPACTA, GRIX, GX, GT. Medidas: AxBxH / 800x640x745 mm.

KIT FEKAFOS 280 DOUBLE (para 2 bombas): Depósito: 280 lts. 2 minizócalos de anclaje. 3 Interruptores de nivel. Puede usarse con las siguientes bombas: COMPACTA, GRIX, GX, GT. Medidas: AxBxH / 800x640x745 mm.

KIT DRENOBOX 600 (para 2 bombas): Depósito 600 lts., 2 minizócalos de anclaje. Puede usarse con las siguientes bombas: COMPACTA, GRIX, GX, GT. Medidas: AxBxH / 920x1.100x745 mm.

Para tamaños superiores consulten con nuestro departamento técnico.



Description: Automatic stations for storing and rising civil and industrial residual waters to the drain network:

FEKABOX 110 (only for 1 pump): Container of 110 lit. made of high density polyethylene, to use with one

pump. Includes automatic coupling finger and connection accessories for pumps in 2". **This faecal station does not include the pump.**

FEKABOX 200 (only for 1 pump): Container of 200 lit. made of high density polyethylene, to use with one pump. Includes automatic coupling finger and connection accessories for pumps in 2". **This faecal station does not include the pump.**

FEKAFOS 280 (only for 1 pump): Container of 280 lit. made of high density polyethylene, to use with one pump. Includes automatic coupling finger and connection accessories for pumps in 2". **This faecal station does not include the pump.**

FEKAFOS 280 DOUBLE (for 2 pumps): Container of 280 lit. made of high density polyethylene, to use with two pumps. Includes automatic coupling finger and connection accessories for pumps in 2". **This faecal station does not include the pump.**

KIT DRENOBOX 600 (for 2 pumps): Container of 600 lit. made of high density polyethylene, to use with two pumps. Includes two automatic coupling fingers and connection accessories for pumps in 2". **This faecal station does not include the pump.**

For larger sizes consult our technical department.

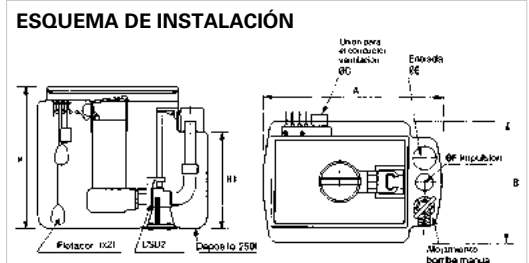

DRX

aguas fecales drenaje
drainage waste water



Turbina en Acero Inoxidable
Stainless Steel Impeller



Aplicaciones:

Bombas sumergibles idóneas para el drenaje de aguas turbias y arenosas que contengan sólidos de máximo 8 mm. de diámetro.

Características constructivas:

Cuerpo bomba, turbina, rejilla, base de aspiración, asa, eje y carcasa de motor en acero inoxidable AISI-304. Doble sello mecánico y cámara intermedia de aceite atóxico. Equipada con 10 metros de cable HO7-RNF.

Motor:

Motor en seco, refrigerado mediante líquido bombeado. Todos los motores incorporan de serie una protección termo amperimétrica. Temperatura del líquido: de + 0° C a + 35° C. Inmersión máxima 10 metros.



Applications:

Submersible electro pump ideal for drainage and dirty-sandy waters, containing solids no larger than 8 mm. of diameter.

Constructive characteristics:

Pump body, impeller, filter, base, handle and casing in stainless steel AISI 304. Double mechanical seal with intermediate oil chamber. Supplied with 10 mts of H07-RNF cable.

Motor:

Dry motor, cooled with the pumped liquid. Temperature of the liquid: from + 0° C to + 35° C. IP 68. Class F. Maximum immersion 10 meters.

Tipo Type	Potencia		"A"		Altura m.c.a. / Height w.c.m.														Paso sólidos Free Pass mm.	Ø IMP. Outlet
	HP	KW	II 230	III 400	4	5	6	7	8	9	10	11	12	14	16	18	20			
Caudal m ³ /h / Flow m ³ /h																				
DRX 7 M Aut	0,75	0,55	4,2	-	15	13	11	9	7,5	5	2,5							8	11/2"	
DRX 10 M Aut	1	0,75	5,1	-	20	18	16	14,5	12	10	8,5	7	4					8	11/2"	
DRX 10 T			-	1,9																
DRX 15 M Aut	1,5	1,1	8,3	-	23	21	19	17	15	13	12	10,5	8,5	5				8	11/2"	
DRX 15 T			-	2,8																
DRX 20 T	2	1,5	-	3,6				24	22,5	21	20	18	16	15	12	8	4,5	1	8	11/2"

DG

aguas fecales drenaje
drainage waste water



Aplicaciones:

Bomba centrífuga sumergible con camisa de acero inoxidable idónea para el desagüe de aguas sucias y cargadas en general.

Características constructivas:

Cuerpo impulsión, tapa superior motor y turbina en fundición de hierro. Eje bomba, filtro y camisa en acero inoxidable AISI-304. Dispone de doble sello mecánico con cámara intermedia de aceite atóxico.

Motor:

Motor en seco, refrigerado mediante líquido bombeado. Versiones monofásicas incorporan una protección termo amperimétrica. Temperatura del líquido: +0°C a +40° C. Aislamiento Clase F.



Applications:

Submersible centrifugal pump with stainless steel sleeve that is ideal for draining dirty waters and waters that are generally loaded.

Constructive characteristics:

Pump body, upper motor cover and impeller in cast iron. Pump shaft, strainer and sleeve in stainless steel AISI-304. Double mechanical seal with intermediate oil chamber.

Motor:

Dry motor, cooled with the pumped liquid. Single phase pumps includes a thermal protection. Temperature of the liquid: from + 0°C to +40°C. Isolation Class F.

Tipo Type	Cond. µF	Potencia		"A"		Altura m.c.a. / Height w.c.m.								Paso Solido mm.	Ø Imp.	
		HP	KW	II 230	III 400	3	6	9	12	15	18	21	24			27
						Caudal m³/h / Flow m³/h										
DG 20 T	-	2	1,5	-	3,3	46	40	32	23,5	13	3	-	-	-	10	2"
DG 30 T	-	3	2,2	-	4,8	57	50	42,5	33	24	12,5	2	-	-	10	2"
DG 50 T	-	5	3,7	-	7,9	72	66	60	53	45	38	28	18	8	10	3"

ACCESORIOS DE INSTALACIÓN



VÁLVULAS DE COMPUERTA / GATE VALVES



ZÓCALOS DE ANCLAJE / PEDESTAL KITS



**INTERRUPTORES DE NIVEL DE 6 Y 15 METROS
6 AND 15 METERS FLOAT SWITCHES**



**VÁLVULAS DE RETENCIÓN
NON RETURN VALVES**



**CUADROS DE PROTECCIÓN Y MANIOBRA
CONTROL PANELS**

CONTROL Y PROTECCIÓN

VARIADORES DE FRECUENCIA

138

**SELECCIÓN DISPOSITIVOS
DE CONTROL
CONTROL DEVICES SELECTION**

139

[e] MOTION

140

[e] JOY

141

[e] POOL

CUADROS ELÉCTRICOS

142

EASYTRONIC

144

SMART

145

**PISCINAS / POZOS
SWIMMING POOLS / BOREHOLE**

146

**VARIADOR DE
FRECUENCIA
FREQUENCY DRIVE**

147

**ARRANCADOR SUAVE
SOFT STARTER**

148

**PRESIÓN Y FECALES
PRESSURE AND SEWAGE**

149

**CONTRA INCENDIOS
FIRE FIGHTING**



Tabla de selección rápida

La siguiente tabla muestra la compatibilidad de muchas de nuestras bombas con los dispositivos de control y maniobra electrónicos disponibles.

Es importante tener en cuenta la limitación de potencia que se indica para cada dispositivo, ya que este puede ser compatible con solo una parte de las bombas indicadas, en función de la potencia del motor de la bomba.



Quick selection table

The following table shows the compatibility of many of our pumps with available electronic control and maneuvering devices.

It is important to take into account the power limitation indicated for each device, since it may be compatible with only a part of the indicated pumps, depending on the power of the pump motor.

Tabla de selección rápida <i>Quick selection table</i>		Cuadro electrónico para bombas de piscina de uso privado o comunitario hasta 5,5HP <i>Electronic panel for pool pumps for private or community use up to 5.5HP</i>	Variador de velocidad para bombas de uso privado o comunitario hasta 5,5HP <i>Variable speed drive for private or commercial use pumps up to 5.5HP</i>	Variador de velocidad para bombas de piscina pública hasta 20HP <i>Variable speed drive for public pool pumps up to 20HP</i>	Cuadro electrónico para bombas de aguas sucias, bombas de presión y bombas de pozo profundo hasta 5,5HP <i>Control panel for waste water pumps, pressure pumps and deep well pumps up to 5.5HP</i>	Variador de frecuencia para bombas de presión hasta 20HP <i>Variable frequency drive for pressure pumps up to 20HP</i>
Aplicación <i>Application</i>	Modelo bomba <i>Pump type</i>	SMART POOL SMART POOL PRO	[e]JOY	[e]POOL	EASYTRONIC EASYTRONIC ONE	[e]MOTION
PISCINA <i>SWIMMING POOL</i>	OPTIMA	✓	✓	✓	-	-
	WINNER	✓	VSD WINNER	✓	-	-
	SUPRA	✓	VSD SUPRA	✓	-	-
	MAGNUS	-	✓	VSD MAGNUS	-	-
	BRAVUS	✓	VSD BRAVUS	✓	-	-
	KONTRA	-	✓	VSD KONTRA	-	-
	CF-2 - HF-2	-	✓	✓	-	-
CF-4 - HF-4	-	✓	✓	-	-	
BR-2	-	✓	✓	-	-	
SUPERFICIE <i>SURFACE</i>	SIGMA	-	-	-	✓	✓
	JET	-	-	-	✓	✓
	AP	-	-	-	✓	✓
	PE	-	-	-	✓	✓
SUMERGIBLES <i>SUBMERSIBLES</i>	DIVERTECH	-	-	-	✓	✓
	NOVA - FEKA	-	-	-	✓	-
	MINI DRX	-	-	-	✓	-
VERTICALES <i>VERTICAL</i>	V-NOX	-	-	-	✓	✓
	XV-F	-	-	-	✓	✓
	XVN-F	-	-	-	✓	✓
	VAT	-	-	-	✓	✓
RIEGO <i>IRRIGATION</i>	K	-	-	-	✓	✓
	CB	-	-	-	✓	✓
	KI	-	-	-	✓	✓
TRASVASE <i>TRANSFER</i>	MN	-	-	-	✓	✓
	NKM-G - NKP-G	-	-	-	✓	✓
	KDN	-	-	-	-	✓
POZO PROFUNDO <i>DEEP WELL</i>	AR	-	-	-	✓	✓
	SP	-	-	-	✓	✓
	AS6	-	-	-	-	✓
	SX	-	-	-	-	✓
AGUAS SUCIAS <i>WASTE WATER</i>	VORT	-	-	-	✓	-
	COMPACTA	-	-	-	✓	-
	VG / VN	-	-	-	✓	-
	GRIX/GX/GT	-	-	-	✓	-
	HT	-	-	-	✓	-
	M	-	-	-	✓	-
	VT	-	-	-	-	-
	DRX	-	-	-	✓	-
DG	-	-	-	✓	-	

[e]MOTION



Descripción:

El nuevo variador de frecuencia [e]MOTION es un sistema de control a través de la modulación de frecuencia o velocidad para conseguir un gran confort y reducir al máximo los costes energéticos, además de los siguientes beneficios:

- Presión totalmente fija
- Ahorro energético
- Trabajo muy silencioso
- Conectividad total
- Versatilidad total
- Puesta en marcha extremadamente simple
- Protege la instalación
- Gran display LCD

Ventajas adicionales:

- Protección contra sobre tensiones
- Protección contra sobreconsumo del motor
- Protección contra fluctuaciones eléctricas
- Protección contra trabajo en seco
- Protección contra rotura de tuberías
- Ajustes finos protegidos por contraseña
- Reset automático de protecciones
- Histórico de fallos y avisos
- Contador de parámetros mas importantes



Description:

The new frequency inverter [e]MOTION is a new control System by frequency or speed modulation to get great comfort and minimize the energy costs plus the following benefits:

- Extremely fixed pressure
- Energy saving
- Very silent working
- Full connectivity
- Full versatility
- Start-up extremely simple
- Protect the installation
- Big LCD display

Additional advantages:

- Over pressure protection
- Over current protection
- Voltage fluctuations protection
- Dry running protection
- Broken pipe protection
- Fine settings blocked by password
- Automatic reset of protections
- Failures and incidents history
- Counter of the most important parameters

Tipo / Type	Tension Entrada Supply Voltage	Tension Salida Motor	Amperaje Máximo Max. Consumption	Potencia / Power	
				kW	HP
(e)motion MT2-11A	1 ~ 230 V	3 ~ 230 V	11 A	2,2	3
(e)motion TT3-11A	3 ~ 400 V	3 ~ 400 V	11 A	4	5,5
(e)motion TT3-30A	3 ~ 400 V	3 ~ 400 V	30 A	15	20

[e]JOY

Variador de velocidad para bombas de piscina privada
Variable speed drive for private pool pumps



Soporte de pared opcional
Wall support on demand



El nuevo variador de velocidad [e]joy es un nuevo sistema de control de velocidad para bombas, con el objetivo de conseguir un gran confort y reducir al máximo los costes energéticos, además de los siguientes beneficios:

- 3 velocidades seleccionables desde teclado
- 5 ciclos de filtración diarios configurables
- Programa para la limpieza del filtro
- Control de iluminación de la piscina
- Pulsador AUT para hacer el sistema autónomo
- Función SKIMMING de limpieza de la superficie del agua
- Hasta 4 entradas para controlar la velocidad de la bomba externamente
- 2 salidas para activación de clorador salino, monitorización del estado de la bomba, etc...
- Protección de las bombas por sobre tensión y sobre consumo eléctrico
- Protección contra el trabajo en seco
- Protección contra rotura de tubería.

Además incorpora una serie de ajustes automáticos como son:

- Reset automático de las protecciones de la bomba
- Registro de fallos e incidencias
- Contadores de horas de funcionamiento



The new variable speed drive [e]joy is a new speed control system for pumps, with the aim of achieving great comfort and minimizing energy costs, in addition to the following benefits:

- 3 selectable keyboard speeds
- 5 configurable daily filtration cycles
- Filter cleaning program
- Pool lighting control
- AUT button to make the system autonomous
- SKIMMING water surface cleaning function
- Up to 4 inputs to control the pump speed externally
- 2 outputs for saline chlorinator activation, pump status monitoring, etc ...
- Protection of pumps for over voltage and electrical consumption
- Protection against dry running
- Protection against pipe breakage

It also incorporates a series of automatic adjustments such as:

- Automatic reset of pump protections
- Record of failures and incidents
- Operating hours counters

[e]POOL

Variador de velocidad para bombas de piscina publica
Variable speed drive for commercial pool pumps



[e]Pool Controller



El nuevo variador de velocidad [e]pool es valido para todas las bombas de piscina pública del mercado, desde 3HP hasta 20HP. El Sistema permite la programación de varios ciclos de filtración diarios con diferente velocidad de funcionamiento para cada ciclo. En instalaciones con varias bombas, el variador se comunicará y alternará con resto de variadores para que las bombas trabajen el mismo número de horas. Además, es capaz de hacer funcionar varias bombas a la vez. Gracias a un sencillo asistente, se proporciona la información necesaria a la bomba para tener una instalación completamente operativa. Con la ayuda de un transductor de presión y un pequeño cuadro eléctrico (se suministran a parte) es capaz de efectuar la limpieza automática de los filtros de arena, si estos disponen de válvulas motorizadas.



soporte de pared opcional
wall support on demand



The new [e]pool speed drive is available for all commercial swimming pool pumps on market, from 3HP to 20HP. The system allows the programming of several cycles per day with different speed for each cycle. In installations with several pumps,-

the drive communicate and alternate to the otherspeed drives to work the pumps the same amount of hours. Capable to work more than one pump at the same time. The software is specially developed for the automation of the pump. An easy setup wizard is provided to leave the pump and the installation fully operational. With the help of a pressure transducer and a small electrical panel (supplied separately) it is capable of automatically cleaning the sand filters, if they have motorized valves.

Características principales:

• Válido para todas las bombas del mercado

- Ahorro energético muy significativo debido a que la bomba puede modificar su velocidad de trabajo a los requerimientos de la instalación.
- Diferentes velocidades de trabajo para diferentes programaciones.
- Comunicación entre varias bombas.
- Alternancia de trabajo por tiempo.
- **Sistema de limpieza automático de filtros**
- Protección de sobrecarga del motor por consumo.
- Sistema de auto aprendizaje para la búsqueda constante de los parámetros que determinan un funcionamiento en seco.

Main characteristics:

• Valid for all pumps on the market

- Very significant energy saving due to the pump can modify his working speed to the installation requirements.
- Different work speeds by different schedules.
- Communication between pumps.
- Alternate working by time.
- **Automatic filter back wash cleaning.**
- Motor overload protection by consumption.
- Self learning system for constant search of the parameters that determine the dry running.

EASYTRONIC

un solo cuadro para todos los usos:

- ▶ eq. presión, aguas sucias, bomba pozo, combinado
- ▶ controla 1 y 2 bombas
- ▶ hasta 5,5 HP cada bomba
- ▶ 230V mono, 230V trif, 400V trif, 50Hz y 60Hz

one control box for all uses:

- ▶ *booster set, waste water, well pumps, combined*
- ▶ *control 1 and 2 pumps*
- ▶ *up to 5,5HP each pump*
- ▶ *230V mono, 230V three, 400V three, 50Hz and 60Hz*



Aguas Sucias / Waste Water
Grupos de presión / Booster sets
Bomba de pozo / Borehole pumps
2 bombas independientes / 2 independent pumps



PARA 1 Y 2 BOMBAS HASTA 5,5HP

EASYTRONIC es cuadro electrónico que puede usarse tanto para controlar un grupo de presión, un conjunto de bombas de aguas sucias, instalación con una bomba de pozo, o 2 bombas completamente independientes entre si, con la misma tensión de alimentación, cada una de estas bombas con su sistema de activación, paro y protección completamente independiente. Puede funcionar en una instalación en una instalación monofásica o trifásica y en función de la alimentación suministrada podrá controlar y proteger 1 o 2 bombas monofásica o trifásicas.

Características principales:

- Control de 1 o 2 bombas
- Alimentación monofásica y trifásica (50-60Hz)
- Control de intensidad de motor por fase
- Protección contra trabajo en seco
- Protección contra sobreconsumo del motor
- Control de fallo/falta/simetría de fases
- Gestión de la alternancia de arranque
- Funcionamiento individual o conjunto
- Entrada 4-20mA para transductor de presión
- Entrada desde programador de riego
- Control de arranque de bombas por temporizador
- Admite sondas de pozo y de depósito
- Alarma acústica de sobrenivel
- Contador de horas de funcionamiento
- Registro de fallos de las bombas
- Reset automático de protecciones

- ▶ También disponible para control de 1 sola bomba
- ▶ Also available to control a single pump



FOR 1 AND 2 PUMPS UP TO 5,5HP

EASYTRONIC is an electronic panel that can be used to control a pressure group, a set of dirty water pumps, installation with a well pump, or 2 pumps completely independent of each other, with the same supply voltage, each of these pumps with its completely independent start, stop and protection system. It can work in a single-phase or three-phase installation and depending on the power supplied it can control and protect 1 or 2 single-phase or three-phase pumps.

Main features:

- Control of 1 or 2 pumps
- Single-phase and three-phase power (50-60Hz)
- Motor current control per phase
- Dry work protection
- Motor overconsumption protection
- Phase failure / fault / symmetry control
- Start alternation management
- Individual or joint operation
- 4-20mA input for pressure transducer
- Input from irrigation programmer
- Timer pump start control
- Supports well and reservoir probes
- Acoustic over-level alarm
- Operating hours counter
- Pump fault log
- Automatic reset of protections



Dispone de las mismas características que el EASYTRONIC 2
All same characteristics as EASYTRONIC 2

SMART

cuadro para bombas de piscina
control panel for pool pumps



Fácil instalación
Easy installation



Control de colores en lámparas led RGB
Control of colours for RGB LED lamps



Control filtración
Filtration control



Protección de la bomba contra el trabajo en seco
Dry running pump protection



Activación mediante señal desde bomba de calor
Activation by external signal from heat pump



Activación manual de la bomba y los focos
Manual activation for pump and focus



Control focos
Lights control



Protección por sobreconsumo
Overload protection



Función anticongelación
Anti freeze function



Alertas de mantenimiento
Maintenance alerts



Pantalla multilinguaje
Multilanguage display



Función skimming
Skimming control



Control de clorador salino
Salt chlorinator control



El nuevo SMART Control es un sistema de control integral de la piscina. Este cuadro electrónico nos permite una programación fácil e intuitiva y un control completo de la piscina. Incorpora las máximas protecciones para la bomba (trabajo en seco y sobre consumo). Incluye además relojes programadores de filtración, entradas/salidas para el sistema de iluminación, Clorador salino, Bomba de Calor, sonda de temperatura, etc...

Puede ser instalado en pared o sobre motor en OPTIMAS y WINNER.

- **Válido para todas las bombas del mercado** (SMART POOL para versiones monofásicas, SMART POOL PRO para versiones monofásicas y trifásicas)
- Instalación fácil e intuitiva
- Control completo de nuestra piscina
- Incorpora las protecciones necesarias para la bomba (trabajo en seco y sobre consumo)
- Seguridad para las personas
- Reloj programador para el control de la filtración y la iluminación (también leds RGB)
- Entradas y salidas para el control y la gestión del sistema de iluminación
- Control de clorador salino
- Bomba de calor
- Sonda de temperatura PT-100, etc...



The new Smart Control panel is a device for controlling the whole pool. This electronic device allows an easy and intuitive programming and a full command of the pool. Includes all the necessary protection for the pump (dry running protection and overload protection). Includes filtration timers and input/outputs for the control of lights, salt chlorinator, heat pump, PT-100 temperature probe... **It can be installed on wall or on motor in OPTIMAS and WINNER.**

- **Valid for all pumps on the market** (SMART POOL for single-phase pumps and SMART POOL PRO for single-phase and three-phase pumps)
- Easy and intuitive installation
- Complete control of our pool
- Incorporates the necessary protections for the pump (dry running protection and overload protection)
- Security for people
- Programmer clock for filtering and lighting control (also RGB leds)
- Inputs and outputs for control and management of the lighting system
- Salt chlorinator control
- Heat pump
- PT-100 temperature probe, etc...

PISCINAS

SWIMMING POOLS



CUADROS ELECTRICOS PARA BOMBAS DE PISCINAS

Tensiones:

230 V monofásico (hasta 3 CV), 230 V trifásico (hasta 5,5 CV), 400 V trifásico, voltajes especiales (50-60 Hz)

Características generales:

Armario	Cajas de material plástico IP-55
Selector de marcha	Selector de 2 posiciones MANUAL - AUTOMÁTICO
Protecciones	Guardamotor bomba (disyuntor magnetotérmico)
Accionamiento	Minicontactor
Protección focos	Magnetotérmico 2 polos 10 A
Programador	Electromecánico, diario, regulación mínima 15 min.
Transformadores	Transformador de seguridad apantallado 350 VA. Cumple UNE-20.339/EN-61558/MIBT028/MIBT035

Funcionamiento:

Equipos destinados a la filtración de piscinas con una sola bomba monofásicas hasta 3 cv y trifásicas hasta 5,5 cv. La orden de filtración puede ser manual o automática a traves del reloj programador. Pueden incorporar 1, 2 o 3 transformadores de 230/12 voltios para focos de 300 watos. El encendido de estos es manual, pero bajo demanda se pueden incorporar sistemas con mando a distancia, o programadores automáticos.

POZOS



CUADROS ELECTRICOS PARA BOMBAS SUMERGIBLES DE POZO

Tensiones:

230 V monofásico (hasta 2 CV), 400 V trifásico (hasta 5,5 CV)

Características generales:

Armario	Cajas de material plástico IP-54
Selector de marcha	Selector de 3 posiciones MAN. - 0 - AUT.
Protecciones	Contactor y relé térmico (sólo contactor en cuadro sin sondas)
Accionamiento	Contactor para arranque directo
Indicadores	Piloto verde de bomba en marcha Piloto rojo de disparo por sobrecarga
Control de nivel	Relé de control de sondas pozo (cuadro CSP) Por consumo eléctrico (cuadro digital sin sondas)
Sondas	Incorpora 3 sondas colgantes (sólo el cuadro CSP)

Funcionamiento:

Equipos destinados al control de bombas sumergidas monofásicas hasta 3 cv, trifásicas y voltajes especiales (50-60 Hz). Incorpora un selector de tres posiciones MAN - PARO - AUTOMÁTICO. En posición manual el funcionamiento es continuado y la bomba solo está protegida de sobrecargas, en automático la orden de marcha puede ser exterior (presostato) o por el controlador de nivel.

VARIADOR DE FRECUENCIA

FREQUENCY DRIVE



Tensiones:

400 V trifásico, voltajes especiales (50-60 Hz)

Características generales:

Tipo de equipo

Básico: 1 bomba regulada + auxiliares
 Alternado: rotación de la bomba regulada (bajo demanda)

Armario

Metálico con ventilación forzada

Int. general

En todas las unidades

Indicadores

Piloto verde de bomba en marcha. Piloto rojo de disparo por sobrecarga
 Piloto amarillo de alarma nivel

Selectores de marcha

Selector de 3 posiciones presostatos - 0 - variador

Protecciones variador

Fusibles rápidos tipo GG/GL

Protecciones bombas aux.

Guardamotor para bombas hasta 15 cv (disyuntor magnetotérmico)
 Fusibles y relés térmicos para potencias superiores

Accionamiento

Arranque directo con un contactor para bombas inferiores a 7,5 cv.
 Arranque estrella - triángulo para potencias superiores a 5,5 cv.

Alternancia

Básico: 1 bomba regulada + rotación de todas las auxiliares
 Alternado: rotación de la bomba regulada (bajo demanda) Rotación total.

Emergencia

Función de emergencia por presostatos de bombas auxiliares
 en caso de avería del variador

Material auxiliar

Transductor de presión 0-10 / 0-16 bar 4-20 mA

Opciones:

Indicadores

Voltímetro general / Amperímetro por bomba / Cuenta horas

Accionamiento

Arranadores suaves en las bombas auxiliares

Protecciones

Diferenciales de alta inmunidad contra disparos intpestivos

Consignas exteriores

Posibilidad de trabajar con varias consignas de presión
 fijas o variables indicadas por fuentes ext.

Señales externas

Analógicas: presión, consumo bomba regulada, velocidad, etc.
 Digitales: avería bomba, marcha, etc.

Aplicaciones

Bombas sumergidas / Bombeos de aguas fecales

Armarios

Poliéster IP-65 (para exteriores)

Funcionamiento:

Equipos destinados a grupos de presión donde se requiera una presión constante.

Con el sistema de regulación de velocidad el equipo adapta el rendimiento de las bombas al consumo de agua que hay en cada momento.

Principales ventajas:

- Evitamos los constantes arranques y paros de los sistemas convencionales alargando la vida mecánica del equipo.
- Evitamos los golpes de ariete en la instalación gracias a la progresividad de equipo.
- Evitamos tener que instalar grandes acumuladores de membrana o galvanizados.
- La potencia absorbida de la red se adapta al máximo al consumo de agua, minimizando los costes, además la utilizada por el variador es casi totalmente activa.

ARRANCADOR SUAVE

SOFT STARTER



Tensiones:

400 V trifásico, voltajes especiales (50-60 Hz). Todos los cuadros para todas las potencias.

Características generales:

Armario	Metálico para todas las potencias
Interruptor general	De serie en todos los cuadros
Indicadores	Piloto verde de bomba en marcha. Piloto rojo de disparo por sobrecarga Piloto amarillo de alarma sobrenivel (sólo para fecales)
Mando	Selector de 3 posiciones MANUAL - PARO - AUTOMÁTICO por bomba
Protecciones	Guardamotor para bombas hasta 15 cv (disyuntor magnetotérmico) Fusibles y relés térmicos para potencias superiores
Accionamiento	Arranque directo (3 hilos) por arrancador suave Arranque a 6 hilos por arrancador suave (bajo demanda)
Alternancia	2 bombas - Alternancia de las dos. 3 bombas - Alternancia de la 1ª - 3ª. 4 bombas - Alternancia de la 1ª - 3ª y 2ª - 4ª
Maniobra	230 Voltios y protegida con fusibles
Alarma	Los cuadros para bombas de aguas fecales disponen de una salida de tensión (230Vac) para un claxon externo de alarma de nivel
Conexionado	Bornero marcado y en posición elevada e inclinada para una fácil conexión de los elementos

Opciones:

Maniobra 24 voltios	En todos los equipos
Alternancia 3 bombas	Alternancia de todas
Interruptor horario	En los equipos de presión para accionar electroválvula.
Maniobra	Cualquier tipo de maniobra especial
Sondas	Sondas pozo o depósito o, sondas pozo y depósito para equipos de presión

Funcionamiento:

Cuadros para equipos de presión:

Materiales periféricos: Presostatos de trabajo y boya de paro nivel o sondas (si se han solicitado).

En manual funciona de forma continuada (sin atender a la presión de impulsión) y solo se para por la boya de paro o por disparo térmico.

En automático conserva las mismas condiciones que en manual, pero el funcionamiento está condicionado a los presostatos de trabajo; estos deben estar regulados en cascada. En equipos de más de una bomba, se alterna el arranque de las bombas.

Cuadros para bombas de aguas fecales:

Materiales periféricos: Boyas de marcha, paro, sobrenivel y claxon exterior de alarma sobrenivel.

En manual el funcionamiento es continuado y solo se para por la boya de paro o por sobrecarga de la bomba.

En automático conserva las mismas condiciones que en manual, pero la orden de marcha se efectúa por las boyas. En equipos de más de una bomba, se alterna el arranque de las bombas. La boya de alarma nivel acciona un claxon exterior, (bajo demanda se puede instalar en el propio cuadro).

PRESIÓN Y FECALES

PRESSURE AND SEWAGE



Tensiones:

230 V monofásico (hasta 3 CV), 230 V trifásico (hasta 20 CV), 400 V trifásico, voltajes especiales (50-60 Hz)

Características generales:

Armario	Poliéster 1 y 2 bombas en potencias inferiores a 7,5 cv. Metálico en todo el resto de gama
Interruptor general	En todos los equipos de 1 y 2 bombas con potencias superiores a 7,5 cv. De serie en equipos de 3 y 4 bombas
Indicadores	Piloto verde de bomba en marcha. Piloto rojo de disparo por sobrecarga Piloto rojo intermitente de alarma de sobrenivel (sólo para fecales)
Mando	Selector de 3 posiciones MANUAL - PARO - AUTOMÁTICO por bomba
Protecciones	Guardamotor para bombas hasta 15 cv (disyuntor magnetotérmico) Fusibles y relés térmicos para potencias superiores
Accionamiento	Arranque directo con un contactor para bombas inferiores a 7,5 cv. Arranque estrella triángulo para potencias superiores a 5,5 cv.
Alternancia	2 bombas - Alternancia de las dos. 3 bombas - Alternancia de la 1ª - 3ª. 4 bombas - Alternancia de la 1ª - 3ª y 2ª - 4ª
Maniobra	230 Voltios
Alarma	En los equipos para aguas fecales salida de tensión para claxon externo de alarma de nivel.

Opciones:

Maniobra 24 voltios	En todos los equipos de presión y aguas fecales.
Alternancia 3-4 bombas	Alternancia de todas
Armario metálico	En los equipos de 1 y 2 bombas inferiores a 7,5 cv
Interruptor general	En los equipos de 1 y 2 bombas inferiores a 7,5 cv.
Interruptor horario	En los equipos de presión para accionar electroválvula.
Maniobra	En equipos de aguas fecales, boyas independientes de paro para cada bomba

Funcionamiento:

Cuadros para equipos de presión:

Materiales periféricos: Presostatos de trabajo y boya de paro nivel (o presostato inversado en bombeos desde la red general).
En manual funciona de forma continuada (sin atender a la presión de impulsión) y solo se para por la boya de paro o por disparo térmico.

En automático conserva las mismas condiciones que en manual, pero el funcionamiento está condicionado a los presostatos de trabajo; estos deben estar regulados en cascada. En equipos de más de una bomba, se alterna el arranque de las bombas.

Cuadros para bombas de aguas fecales:

Material periférico: Boyas de marcha, paro, sobrenivel y claxon exterior de alarma sobrenivel.

En manual el funcionamiento es continuado y solo se para por la boya de paro o por sobrecarga de la bomba.

En automático conserva las mismas condiciones que en manual, pero la orden de marcha se efectúa por las boyas. En equipos de más de una bomba, se alterna el arranque de las bombas. La boya de alarma nivel acciona un claxon exterior, (bajo demanda se puede instalar en el propio cuadro). La boya de nivel mínimo es para todas las bombas, (bajo demanda se pueden colocar boyas de paro independientes para cada bomba).

CONTRA INCENDIOS

FIRE FIGHTING



Cuadro de arranque y control para bombas eléctricas y diesel según UNE 23500:2018.

Construido estrictamente bajo la norma **UNE 23500:2018**. Incorpora panel frontal de policarbonato para fácil comprensión de toda la simbología, dentro del mismo armario encontraremos el arranque, control y protección de la bomba auxiliar o jockey.

Los cuadros están compuestos por armario metálico IP55 color rojo Ral 3000, interruptor seccionador general, arrancadores para las bombas, selectores tres posiciones para bomba principal y jockey. Pulsadores de prueba de lámparas y alarmas acústicas. Pulsador de paro de bomba principal. Protección térmica para bomba jockey, voltímetro, amperímetro, contador de arranques jockey, sirena de alarma, batería de soporte. Igualmente, el cuadro de control de bomba diesel, añade sus particularidades, como tacómetro, relojes de temperatura y presión de aceite. En definitiva nuestros cuadros para este tipo de contraincendios incorporan todas las exigencias reflejadas en la normativa **UNE 23500:2018**.

Cuadro de arranque y control para bombas eléctricas y diesel según CEPREVEN RT2 - ABA.

Construido estrictamente bajo las reglas técnicas **CEPREVEN**. Incorpora panel frontal de policarbonato para fácil comprensión de toda la simbología.

Los cuadros están compuestos por armario metálico IP55 color rojo Ral 3000, interruptor seccionador general, arrancadores para las bombas, selectores tres posiciones para bomba principal y jockey. Pulsadores de prueba de lámparas y alarmas acústicas. Pulsador de paro de bomba principal. Protección térmica para bomba jockey, voltímetro, amperímetro, contador de arranques jockey, sirena de alarma, batería de soporte. Igualmente, el cuadro de control de bomba diesel, añade sus particularidades, como 2 cargadores de baterías, prueba de 6 intentos de arranque, pulsador de marcha por batería, amperímetro por batería, tacómetro, relojes de temperatura y presión de aceite. En definitiva nuestros cuadros para este tipo de contraincendios incorporan todas las exigencias reflejadas en la regla técnica **CEPREVEN RT2 - ABA**.



EQUIPOS PRESIÓN Y CONTRAINCENDIOS

GRUPOS DE PRESIÓN

152

EASYTRONIC

153

[e] MOTION

154

**EQUIPOS ARMARIO
ELÉCTRICO
BOOSTER SET**

156

**SELECCIÓN DE BOMBAS
PUMP SELECTION**

GRUPOS CONTRAINCENDIOS

158

**CONTRA INCENDIOS
FIRE FIGHTING UNITS**

EASYTRONIC



Descripción:

Los equipos EASYTRONIC son grupos de presión para 1 y 2 bombas hasta 5.5HP (11A), que permiten el arranque directo de las bombas además de las siguientes ventajas:

- Bombas monofásicas y trifásicas
- Activación por presostatos / boyas / transductor de presión
- Paro por boya / presostato de mínima / sondas de pozo
- Alternancia y funcionamiento conjunto
- Control de amperaje independiente por bomba
- Detección de trabajo en seco y sobreconsumo
- Activación mediante señal de programador de riego
- Activación de las bombas por control horario
- Relés para monitorizar el estado del equipo
- Gran display multilinguaje



Description:

The EASYTRONIC equipments are booster sets for 1 and 2 pumps up to 5.5HP (11A), which allow direct starting of the pumps in addition to the following advantages:

- Single-phase and three-phase pumps
- Activation by pressure switches / float / pressure transducer
- Stop by float / minimum pressure switch / well probes
- Alternation and joint operation
- Independent amperage control per pump
- Detection of dry running and overcurrent
- Activation by irrigation programmer signal
- Activation of the pumps by time control
- Relays to monitor the status of the equipment
- Large multilanguage display
- Large multilanguage display

[e]MOTION



Descripción:

Los grupos con variador de frecuencia [e]motion, que permiten formar conjuntos de hasta 8 bombas de 20HP de potencia, son el máximo exponente en términos de ahorro energético, fácil programación y múltiples opciones de configuración. Incluyen las siguientes especificaciones generales:

- Hasta 8 bombas
- Bombas de hasta 20HP (30A)
- Adaptación instantánea de la velocidad de las bombas a las necesidades de caudal de la instalación.
- Mínimo consumo energético
- Detección de trabajo sin agua y sobre intensidad de las bombas
- Alternancia y funcionamiento conjunto
- Relés para monitorizar el estado del equipo
- Gran display multilingüaje



Description:

The groups with [e]motion frequency inverter, which allow to form sets of up to 8 pumps of 20HP of power, are the maximum exponent in terms of energy saving, easy programming and multiple configuration options. They include the following general specifications:

- *Up to 8 pumps*
- *Pumps up to 20HP (30A)*
- *Instantaneous adaptation of the speed of the pumps to the flow needs of the installation.*
- *Minimum energy consumption*
- *Detection of work without water and overcurrent*
- *Alternation and joint operation*
- *Relays to monitor the status of the equipment*
- *Large multilanguage display*

EQUIPOS CUADRO ELÉCTRICO



APLICACIONES:

Los equipos de presión son conjuntos diseñados para el suministro automático de agua a presión a distintos tipos de instalaciones como pueden ser: bloques de viviendas, apartamentos, urbanizaciones, riegos, edificios comerciales, hoteles, instalaciones deportivas, industrias, etc.

Equipos compuestos por:

Hasta 4 bombas, manómetro de glicerina, bancada general con soporte cuadro eléctrico, colector de impulsión compuesto con válvulas de bola y válvulas de retención y cuadro eléctrico de mando y protección. Para grupos con variador de frecuencia se incluye transductor de presión y un pequeño acumulador de membrana.



APPLICATIONS:

The pressure units are units designed to automatically supply pressurised water to different kinds of installations, such as: housing blocks, apartments, housing estates, irrigation, commercial buildings, hotels, sport installations, industries, etc.

Our booster sets includes:

Up to 4 pumps, pressure gauges, 1 glycerine manometer, 1 base plate with control box support, general outlet collector with one retention valve and close valve for each pump, electrical control box with standard equipment or with inverter including the pressure trasducer.

CÁLCULO GRUPOS DE PRESIÓN

CÁLCULO DEL CAUDAL NECESARIO / DETERMINATION OF THE NECESSARY FLOW CAUDAL DE LA BOMBA EN / PUMPS FLOW IN m³/h

Tipo de vivienda Type of housing	Nº de viviendas / Nº of housings								
	1	5	10	15	20-30	31-50	51-70	71-90	91-100
	Caudal necesario (m ³ /h) / Required flow (m ³ /h)								
1 Baño	2,30	5,29	7,42	9,00	10,80	12,30	13,39	14,25	14,62
2 Baños	2,69	6,10	8,51	9,71	11,62	13,22	14,38	15,29	15,69
3 Baños	3,10	6,94	9,36	10,41	12,44	14,13	15,35	16,32	16,74

DETERMINACIÓN DE LA PRESIÓN DE TRABAJO / DETERMINATION OF THE WORKING PRESSURE:



La Altura Manométrica requerida o Presión de arranque vendrá definida por la siguiente suma:

$$Pa = Hg + Pc + Hr + Ha$$

Ejemplo: tenemos un edificio de 4 plantas + 2 sótanos, el grupo de presión está situado en el primer sótano y con una altura de aspiración de 3,5 m.c.a.

La presión de servicio o de trabajo será:

- **Hg** (Altura Geométrica): (4 plantas + 1 sótano) x 3 m.c.a. = 15 m.c.a.
- **Pc** (Pérdidas de Carga 15% de Hg): 15% de 15 m.c.a. = 2,25 m.c.a.
- **Hr** (Presión necesaria en el punto más alto) = 20 m.c.a. (orientativo)
- **Ha** (Altura de Aspiración) = 3,5 m.c.a.

$$Pa = Hg + Pc + Hr + Ha = 15 \text{ m.c.a.} + 2,25 \text{ m.c.a.} + 20 \text{ m.c.a.} + 3,5 \text{ m.c.a.}$$

$$Pa = 40,75 \text{ m.c.a.} = 4,1 \text{ bar} = \text{Presión de trabajo}$$



The Manometric Height required or starting Pressure is defined by the following sum:

$$Pa = Hg + Pc + Hr + Ha$$

Example: we have a 4 floor housing + 2 floor underground, the pressure unit is locate in the first floor below ground, and the suction head is 3,5 w.c.m.

The working pressure will be:

- **Hg** (Geometric Height): (4 floors + 2 Underfloor) x3 m.c.a. = 18 m.c.a.
- **Pc** (Load Losses): 15% de 18 m.c.a. = 2,7 m.c.a.
- **Hr** (Residual Height) = 20 m.c.a.
- **Ha** (Suction Height) = 3,5 m.c.a.

$$Pa = Hg + Pc + Hr + Ha = 18 \text{ m.c.a.} + 2,7 \text{ m.c.a.} + 20 \text{ m.c.a.} + 3,5 \text{ m.c.a.}$$

$$Pa = 44,2 \text{ m.c.a.} = 4,5 \text{ bar} = \text{Working pressure}$$



SIGMA - V-NOX - XV-F

TIPO BOMBA PUMP TYPE	Potencia Bomba Pump Power		CAUDAL TOTAL 4 BOMBAS / 4 PUMPS TOTAL FLOW											
			0	8	16	24	32	40	48	56	64	72	80	88
			CAUDAL TOTAL 3 BOMBAS / 3 PUMPS TOTAL FLOW											
	HP KW		CAUDAL TOTAL 2 BOMBAS / 2 PUMPS TOTAL FLOW											
			0	4	8	12	16	20	24	28	32	36	40	44
	HP KW		CAUDAL TOTAL 1 BOMBA / 1 PUMP TOTAL FLOW											
			0	2	4	6	8	10	12	14	16	18	20	22
ALTURA m.c.a / HEIGHT w.c.m														
SIGMA 102	0,33	0,25	23	15	1									
SIGMA 103	0,5	0,37	34	23	1,5									
SIGMA 104	0,75	0,55	45	31	2									
SIGMA 105	1	0,75	56	38	3									
SIGMA 202	1	0,75	23	21	18	13								
SIGMA 203	1	0,75	34	32	27,5	19								
SIGMA 204	1,2	0,9	44	41,5	35,5	24								
SIGMA 205	1,5	1,1	57	54	46,5	32								
SIGMA 303	1,2	0,9	39	38	36	32	24	14						
SIGMA 304	1,5	1,1	51	51	48	42	32	18						
SIGMA 305	2	1,5	65	64	59	52	40	24						
SIGMA 306	3	2,2	77	76	72	63	48	28						
SIGMA 307	3	2,2	90	88	82	70	54	32						
SIGMA 403	2	1,5	35	34,5	34	33	31,5	29	27	24	21	18	14	8
SIGMA 404	3	2,2	44	43	42	41	37	35	32	28	24	21	16	10
V-NOX 303	1,2	0,9	39	38	36	32	24	14						
V-NOX 304	1,5	1,1	51	50	48	42	32	18						
V-NOX 305	2	1,5	65	64	59	52	40	24						
V-NOX 306	3	2,2	77	76	72	63	48	28						
V-NOX 307	3	2,2	90	88	82	70	54	32						
V-NOX 308	4	3	106	102	95	84	64	36						
V-NOX 309	4	3	120	115	107	92	56	42						
V-NOX 310	5,5	4	133	126	119	104	64	48						
V-NOX 403	2	1,5	35	34,5	34	33	31,5	29	27	24	21	18	14	8
V-NOX 404	3	2,2	44	43	42	41	37	35	32	28	24	21	16	10
V-NOX 405	4	3	55	54	53	51,5	48	46	43	39	34	29	21	14
V-NOX 406	4	3	66	64,5	63	61	56	54	51	46	40	34	27	17
V-NOX 407	5,5	4	77	76	75	73	67	64	60	54	47	41	34	20
XV-F 5-8	1,5	1,1	52	48	43	34	22							
XV-F 5-10	2	1,5	65	62	56	46	32							
XV-F 5-14	3	2,2	93	90	82	67	47							
XV-F 5-16	3	2,2	108	103	92	77	54							
XV-F 5-20	4	3	135	131	118	98	68							
XV-F 5-29	5,5	4	197	192	176	148	107							
XV-F 5-36	7,5	5,5	246	236	216	182	132							
XV-F 10-6	3	2,2	60	60	59	58	53	46	37					
XV-F 10-9	4	3	90	89	88	87	80	70	57					
XV-F 10-10	5,5	4	101	100	99	98	91	79	64					
XV-F 10-12	5,5	4	121	120	119	117	108	95	77					
XV-F 10-16	7,5	5,5	162	160	158	156	145	128	104					
XV-F 10-22	10	7,5	225	223	221	218	202	178	145					
XV-F 15-5	5,5	4	68	68	67	67	66	64	62	58	55	51	46	40
XV-F 15-7	7,5	5,5	97	97	96	95	93	90	87	82	78	72	66	59
XV-F 15-9	10	7,5	125	124	123	122	120	118	113	108	102	95	86	76
XV-F 15-14	15	11	194	193	192	190	187	183	178	170	160	149	135	120
XV-F 15-17	20	15	237	236	235	233	229	225	217	208	190	182	165	147

XV-F

TIPO BOMBA PUMP TYPE	Potencia Bomba		CAUDAL TOTAL 4 BOMBAS / 4 PUMPS TOTAL FLOW													
			0	32	64	112	160	200	288	360	432	528	600	720		
	Pump Power		CAUDAL TOTAL 3 BOMBAS / 3 PUMPS TOTAL FLOW													
			0	24	48	84	120	150	216	270	324	396	450	540		
	HP		KW		CAUDAL TOTAL 2 BOMBAS / 2 PUMPS TOTAL FLOW											
					0	15	32	56	80	100	144	180	216	264	300	360
HP		KW		CAUDAL TOTAL 1 BOMBA / 1 PUMP TOTAL FLOW												
				0	8	16	28	40	50	72	90	108	132	150	180	
ALTURA m.c.a / HEIGHT w.c.m																
XV-F 20-5	7,5	5,5	70	69	63	37										
XV-F 20-7	10	7,5	102	97	90	54										
XV-F 20-10	15	11	145	142	130	80										
XV-F 20-14	20	15	204	200	185	113										
XV-F 20-17	25	18,5	250	245	226	140										
XV-F 32-3	7,5	5,5	58	57	55	42	29									
XV-F 32-4	10	7,5	76	76	73	58	39									
XV-F 32-6	15	11	116	115	110	90	61									
XV-F 32-8	20	15	154	155	148	120	82									
XV-F 32-10	25	18,5	194	196	187	152	106									
XV-F 32-12	30	22	232	235	226	185	127									
XV-F 32-14	40	30	273	277	272	217	153									
XV-F 45-2	10	7,5	50	49	48	46	42	34								
XV-F 45-3	15	11	75	74	73	71	65	53								
XV-F 45-4	20	15	100	99	98	96	86	71								
XV-F 45-5	25	18,5	125	124	123	121	108	90								
XV-F 45-6	30	22	151	150	149	147	131	110								
XV-F 45-9-2	40	30	218	217	215	213	190	158								
XV-F 45-10	50	37	252	250	248	245	222	185								
XV-F 45-13-2	60	45	320	319	318	317	286	237								
XV-F 64-2	15	11	62		60	58	54	51	40							
XV-F 64-3-1	20	15	78		76	75	71	65	54							
XV-F 64-4-2	25	18,5	98		97	96	92	81	68							
XV-F 64-4	30	22	118		115	111	106	100	84							
XV-F 64-6-2	40	30	156		154	152	145	135	114							
XV-F 64-7-1	50	37	195		193	189	180	170	143							
XV-F 64-8-1	60	45	223		222	221	211	198	167							
XV-F 90-2-2	15	11	48			45	44	43	37	28	16					
XV-F 90-2	20	15	68			61	58	55	48	42	32					
XV-F 90-3-2	25	18,5	80			77	74	72	61	50	34					
XV-F 90-3	30	22	102			92	88	84	74	64	50					
XV-F 90-4	40	30	136			126	119	114	99	88	70					
XV-F 90-5	50	37	170			156	149	144	127	110	88					
XV-F 90-6	60	45	204			189	181	175	154	135	108					
XV-F 120-1	15	11	29				27	26	24	23	20	16				
XV-F 120-2-1	25	18,5	51				48	47	43	41	36	29				
XV-F 120-2	30	22	59				56	55	51	49	44	37				
XV-F 120-3	40	30	88				84	83	77	74	67	57				
XV-F 120-4-1	50	37	110				105	103	96	92	83	70				
XV-F 120-5-1	60	45	140				136	133	124	119	107	92				
XV-F 120-6-1	75	55	170				163	160	150	143	130	112				
XV-F 120-7	100	75	210				200	196	184	176	160	138				
XV-F 150-1-1	15	11	22					19,5	18	17	16	14	11	6		
XV-F 150-1	20	15	32					29,5	27	26	24	21	18	14		
XV-F 150-2-1	30	22	54						50	47	46	43	37	32,5	25	
XV-F 150-3-2	40	30	77						71	66	64	60	52	46	36	
XV-F 150-3-2	50	37	97						90	84	81	77	66	60	50	
XV-F 150-4-1	60	45	120						113	105	101	96	83	76	63	
XV-F 150-5-2	75	55	140						132	124	120	115	101	92	75	
XV-F 150-6	100	75	192						184	172	167	154	132	120	104	

CONTRA INCENDIOS



APLICACIONES:

Los equipos de bombeo automáticos descritos en el presente catalogo, son conjuntos diseñados para ofrecer la mejor solución para el suministro de agua a presión en una instalación de protección de incendios, por lo cual son apropiados para muy diversas instalaciones como pueden ser: edificios públicos y privados, grandes superficies comerciales, almacenes, naves industriales ,etc... Nuestra línea de equipos aquí reflejados han sido estudiados para garantizar un funcionamiento fiable y duradero incluso en las condiciones mas extremas, condiciones que en este tipo de aplicaciones son bastante comunes.

SACI PUMPS como punto de partida en el diseño de estos equipos ha tenido en cuenta una serie de premisas básicas:

- Cumplimiento estricto de la normativa vigente **UNE 23500:2018, EN 12845** y las reglas técnicas editadas por **CEPREVEN**.
- Ofrecer una amplia gama de equipos, ya sea en tipo de ejecución, varias bombas principales eléctricas o diesel, normativas UNE, EN ó CEPREVEN y como no, en prestaciones de los mismos: hasta 288 m³/h de caudal nominal y hasta 120 m.c.a. de altura manométrica.
- Diseño compacto, robusto y totalmente preparado, cableado para su puesta en marcha definitiva en destino garantizando de esta forma una **FÁCIL INSTALACIÓN** y un **MÍNIMO MANTENIMIENTO PREVENTIVO**.

EJECUCIONES:

Podemos encontrar diferentes gamas de equipos contraincendios bien diferenciadas:

- 1) Equipos bajo normas **UNE 23500:2018** que dividimos en 4 líneas en función de tipo y nº de bombas principales que incorporan:
 - **U.E.** Equipos que incorporan 1 bomba principal eléctrica y 1 bomba jockey. (Bombeo Simple)
 - **U.E.E.** Equipos que incorporan 2 bombas principales eléctricas y 1 bomba jockey.
 - **U.D.** Equipos que incorporan 1 bomba principal Diesel y 1 bomba jockey. (Bombeo Simple)
 - **U.E.D.** Equipos que incorporan 1 bomba principal eléctrica, 1 bomba principal diesel y 1 bomba jockey.
- 2) Equipos bajo regla técnica **CEPREVEN RT2-ABA** que dividimos en 4 líneas en función de tipo y nº de bombas principales que incorporan:
 - **C.E.** Equipos que incorporan 1 bomba principal eléctrica y 1 bomba jockey.
 - **C.E.E.** Equipos que incorporan 2 bombas principales eléctricas y 1 bomba jockey.
 - **C.D.** Equipos que incorporan 1 bomba principal Diesel y 1 bomba jockey.
 - **C.E.D.** Equipos que incorporan 1 bomba principal eléctrica, 1 bomba principal diesel y 1 bomba jockey.
- 3) Equipos bajo normas **EN 12845** (norma de ámbito europeo) que dividimos en 4 líneas en función de tipo y nº de bombas principales que incorporan:
 - **N.E.** Equipos que incorporan 1 bomba principal eléctrica y 1 bomba jockey.
 - **N.E.E.** Equipos que incorporan 2 bombas principales eléctricas y 1 bomba jockey.
 - **N.D.** Equipos que incorporan 1 bomba principal Diesel y 1 bomba jockey.
 - **N.E.D.** Equipos que incorporan 1 bomba principal eléctrica, 1 bomba principal diesel y 1 bomba jockey.

PARA OTRAS ESPECIFICACIONES CONSULTAR NUESTRO CATÁLOGO TÉCNICO DE EQUIPOS



FIRE FIGHTING UNITS

APPLICATIONS:

The automatic pumping units described herein are designed to offer the best solution for pressurised water supply in a fire fighting installation, and are therefore suitable for highly diverse installations such as:
Public and private buildings, large commercial areas, Stores, Warehouses, etc.

Our line of units we reflect here has been studied to guarantee reliable, lasting working even in the most extreme conditions, conditions where these kinds of applications are quite common.

In commencing the design of these units, BOMBAS SACI has borne in mind a series of basic premises:

- Strict compliance with current **UNE 23500:2018** regulations and all the technical rules published by **CEPREVEN** normally demanded by insurance companies.
- Offer a wide range of units either in execution, several electric or diesel main pumps, UNE or CEPREVEN standards, or in output: up to 288 m³/h nominal flow and up to 120 m.c.a manometric height.
- Compact design, robust and totally prepared, wired for final commissioning at destination, thus guaranteeing an **EASY INSTALLATION** and **MINIMAL PREVENTIVE MAINTENANCE**.

EXECUTIONS:

This catalogue presents 3 different ranges of fire fighting equipment.

- 1) Units under **UNE 23500:2018** standards, which we divide into 4 working lines depending on type and number of main pumps they include:
 - **U.E.** Units incorporating 1 main electric pump and 1 jockey pump. (Simple)
 - **U.E.E.** Units incorporating 2 main electric pumps and 1 jockey pump.
 - **U.D.** Units incorporating 1 main diesel pump and 1 jockey pump. (Simple)
 - **U.E.D.** Units incorporating 1 main electric pump, 1 main diesel pump and 1 jockey pump.
- 2) Units under **CEPREVEN RT2-ABA 96** standards, which we divide into 4 working lines depending on type and number of main pumps they include:
 - **C.E.** Units incorporating 1 main electric pump and 1 jockey pump.
 - **C.E.E.** Units incorporating 2 main electric pumps and 1 jockey pump.
 - **C.D.** Units incorporating 1 main diesel pump and 1 jockey pump.
 - **C.E.D.** Units incorporating 1 main electric pump, 1 main diesel pump and 1 jockey pump.
- 3) Units under **EN 12845** standards, which we divide into 4 working lines depending on type and number of main pumps they include:
 - **N.E.** Units incorporating 1 main electric pump and 1 jockey pump.
 - **N.E.E.** Units incorporating 2 main electric pumps and 1 jockey pump.
 - **N.D.** Units incorporating 1 main diesel pump and 1 jockey pump.
 - **N.E.D.** Units incorporating 1 main electric pump, 1 main diesel pump and 1 jockey pump.

UNE 23500:2018 (simple)

equipamiento sencillo / simple sets

TIPO EQUIPO SET TYPE	POTENCIA HP		CAUDAL m ³ /h / Flow m ³ /h				
	PRAL. ELEC.	JOCKEY	12	18	24	30	36
			ALTURA m.c.a. / Height w.c.m.				
404	3	1,1	33				
405	4	1,3	43				
406	4	1,5	51				
407	5,5	3	60				
15 - 7 ⁽¹⁾	7,5	4	87				
15 - 9 ⁽¹⁾	10	5,5	113				
420 B	7,5	1,7		46	43		
420 A	10	1,7		58	56	53	
425 B	15	3			70	67	
425 A ⁽¹⁾	20	4			87	84	
520 C	12,5	1,7					43
520 B	15	1,7					49
520 A	20	2					56
525 C	20	3					69
525 B	25	3					76
525 A ⁽¹⁾	30	4					88

⁽¹⁾ En equipos diesel, la presión máxima serán 80 mca / In diesel sets, the maximum pressure will be 80 wcm

* LOS GRUPOS CONTRA INCENDIOS SIMPLES SOLAMENTE SON VÁLIDOS PARA EQUIPAMIENTOS SENCILLOS (BIE). PUEDE SUMINISTRARSE EL GRUPO CON 1 BOMBA PRINCIPAL ELÉCTRICA (U.E), 1 DIESEL (U.D), 2 ELÉCTRICAS (U.E.E) Y 1 ELÉCTRICA + 1 DIESEL (U.E.D). EN TODOS LOS CASOS SE INCLUYE LA BOMBA JOCKEY.

* THE SIMPLE FIRE FIGHTING UNITS ARE VALID ONLY FOR SIMPLE EQUIPMENTS (BIE). CAN BE SUPPLIED WITH 1 MAIN ELECTRICAL PUMP (U.E), 1 MAIN DIESEL PUMP (U.D), 2 MAIN ELECTRICAL PUMPS (U.E.E) AND 1 MAIN ELECTRICAL PUMP + 1 MAIN DIESEL PUMP (U.E.D). THE JOCKEY PUMP ALWAYS IS INCLUDED.

UNE 23500:2018 / EN-12845 / CEPREVEN

equipamiento superior / *superior sets*

TIPO EQUIPO SET TYPE	POTENCIA HP		CAUDAL NOMINAL m³/h / Nominal Flow m³/h												
	PRAL. ELEC	JOCKEY	12	18	24	30	36	42	48	60	72	84	96	108	
			ALTURA NOMINAL m.c.a. / Nominal Height w.c.m.												
316 S 17 / 7.5	7,5	2	42	41	38										
320 S 20 / 10	10	2	50	48	45	42									
320 S 22 / 15	15	3	63	62	59	57	53								
425 S 24 / 25	25	3			76	75									
425 S 25 / 30	30	3			82	81									
420 S 22 / 20	20	3					59	57	55						
425 S 23 / 25	25	3					66	64	61						
425 S 25 / 30	30	3					80	78	76						
425 S 26 / 30	30	4				90	89	87	84						
525 S 22 / 30	30	3								60	55				
525 S 23 / 30	30	3								67	62				
525 S 24 / 40	40	3								74	70				
525 S 25 / 40	40	3								82	78				
525 S 26 / 50	50	4						94	93	90	88				
652 S 20 / 30	30	3										53	51	49	
652 S 21 / 40	40	3										59	57	55	
652 S 22 / 40	40	3										66	64	62	
625 S 24 / 50	50	3										71	70	66	
625 S 25 / 50	50	3										80	78	73	
625 S 26 / 60	60	4										92	91	89	87

* PARA CAUDALES SUPERIORES CONSULTE CON NUESTRO DEPARTAMENTO COMERCIAL.

PUEDEN SUMINISTRARSE EL GRUPO CON 1 BOMBA PRINCIPAL ELÉCTRICA, 1 PRINCIPAL DIESEL, 2 PRINCIPALES ELÉCTRICAS Y 1 PRINCIPAL ELÉCTRICA + 1 PRINCIPAL DIESEL. EN TODOS LOS CASOS SE INCLUYE LA BOMBA JOCKEY.

* FOR MORE FLOW REQUIREMENT PLEASE CONTACT WITH OUR COMMERCIAL DEPARTMENT.

CAN BE SUPPLIED WITH 1 MAIN ELECTRICAL PUMP, 1 MAIN DIESEL PUMP, 2 MAIN ELECTRICAL PUMPS AND 1 MAIN ELECTRICAL PUMP + 1 MAIN DIESEL PUMP. THE JOCKEY PUMP ALWAYS IS INCLUDED.



CIRCULADORAS

ROTOR HÚMEDO		ROTOR SECO	
166	EVOSTA-2	184	ALM-ALP
167	EVOSTA-3	185	KLM - KLP - DKLM - DKLP
169	EVOPLUS SMALL	187	CM
172	EVOPLUS	190	CP
179	VS		

ROTOR HÚMEDO *WET ROTOR*

MODELO		P1 MAX. W	Q			
	MONOFASICA GEMELA		0 m³/h	0,6 10	1,2 20	1,8 30
EVOSTA-2 40-70/130	-	35	6,9	5,9	4,5	3,2
EVOSTA-2 40-70/180	-	35				
EVOSTA-3 40/130 M	-	20	4	3,7	2,6	1,6
EVOSTA-3 40/180 M	-	20				
EVOSTA-3 60/130 M	-	35				
EVOSTA-3 60/180 M	-	35	6	5,8	4,7	3,4
EVOSTA-3 60/180 XM	-	35				
EVOSTA-3 80/130 M	-	55				
EVOSTA-3 80/180 M	-	55	8	8	6,6	5
EVOSTA-3 80/180 XM	-	55				
EVOPLUS 60/180 XM (SMALL)	-	100	6,1		6,1	6,1
EVOPLUS 80/180 XM (SMALL)	-	135	8,1		8,1	8,1
EVOPLUS 110/180 XM (SMALL)	-	170	11,3		11,3	11,3
EVOPLUS B 40/220.32 M (SMALL)	EVOPLUS D 40/220.32 M (D SMALL)	75	4,1			
EVOPLUS B 60/220.32 M (SMALL)	EVOPLUS D 60/220.32 M (D SMALL)	105	6			
EVOPLUS B 80/220.32 M (SMALL)	EVOPLUS D 80/220.32 M (D SMALL)	140	8			
EVOPLUS B 110/220.32 M (SMALL)	EVOPLUS D 110/220.32 M (D SMALL)	190	11			
EVOPLUS B 120/220.32 M (SMALL)	EVOPLUS D 120/220.32 M (D SMALL)	340	12			
EVOPLUS B 60/250.40 M (SMALL)	EVOPLUS D 60/250.40 M (D SMALL)	105	6			
EVOPLUS B 80/250.40 M (SMALL)	EVOPLUS D 80/250.40 M (D SMALL)	140	8			
EVOPLUS B 110/250.40 M (SMALL)	EVOPLUS D 110/250.40 M (D SMALL)	190	11			
EVOPLUS B 40/220.40 M	EVOPLUS D 40/220.40 M	90	4			
EVOPLUS B 60/220.40 M	EVOPLUS D 60/220.40 M	175	6			
EVOPLUS B 80/220.40 M	EVOPLUS D 80/220.40 M	260	8			
EVOPLUS B 100/220.40 M	EVOPLUS D 100/220.40 M	350	10			
EVOPLUS B 120/250.40 M	EVOPLUS D 120/250.40 M	465	12			
EVOPLUS B 150/250.40 M	EVOPLUS D 150/250.40 M	610	15			
EVOPLUS B 180/250.40 M	EVOPLUS D 180/250.40 M	610	18			
EVOPLUS B 40/240.50 M	EVOPLUS D 40/240.50 M	140	4			
EVOPLUS B 60/240.50 M	EVOPLUS D 60/240.50 M	260	6			
EVOPLUS B 80/240.50 M	EVOPLUS D 80/240.50 M	330	8			
EVOPLUS B 100/280.50 M	EVOPLUS D 100/280.50 M	430	10			
EVOPLUS B 120/280.50 M	EVOPLUS D 120/280.50 M	530	12			
EVOPLUS B 150/280.50 M	EVOPLUS D 150/280.50 M	640	15			
EVOPLUS B 180/280.50 M	EVOPLUS D 180/280.50 M	750	18			
EVOPLUS B 40/340.65 M	EVOPLUS D 40/340.65 M	190	4			
EVOPLUS B 60/340.65 M	EVOPLUS D 60/340.65 M	355	6			
EVOPLUS B 80/340.65 M	EVOPLUS D 80/340.65 M	465	8			
EVOPLUS B 100/340.65 M	EVOPLUS D 100/340.65 M	590	10			
EVOPLUS B 120/340.65 M	EVOPLUS D 120/340.65 M	730	12			
EVOPLUS B 150/340.65 M	EVOPLUS D 150/340.65 M	1210	15,2			
EVOPLUS B 40/360.80 M	EVOPLUS D 40/360.80 M	330	4			
EVOPLUS B 60/360.80 M	EVOPLUS D 60/360.80 M	535	6			
EVOPLUS B 80/360.80 M	EVOPLUS D 80/360.80 M	670	8			
EVOPLUS B 100/360.80 M	EVOPLUS D 100/360.80 M	1005	10			
EVOPLUS B 120/360.80 M	EVOPLUS D 120/360.80 M	1235	12			
EVOPLUS B 40/450.100 M	EVOPLUS D 40/450.100 M	530	4			
EVOPLUS B 60/450.100 M	EVOPLUS D 60/450.100 M	760	6			
EVOPLUS B 80/450.100 M	EVOPLUS D 80/450.100 M	1080	8			
EVOPLUS B 100/450.100 M	EVOPLUS D 100/450.100 M	1380	10			
EVOPLUS B 120/450.100 M	EVOPLUS D 120/450.100 M	1560	12,2			

tablas de selección rápida / numerical selection table

2,4 40	3 50	4,2 70	5,4 90	7,2 120	9,6 160	12 200	14,4 240	18 300	21 350	24 400	27 450	30 500	33 550	36 600	42 700	54 900	60 1000	72 1200
2,4	1,7																	
1,1																		
2,6	1,8																	
4,1	3	1,2																
6,1	5,7	4	3	1,8														
8,1	7,5	6,1	4,5	3,2	0,8													
11,3	9	7,5	6,1	4,3	2													
4,1	4,1	3,3	2,6	1,3														
6	5,5	4,7	3	2,5	0,6													
8	7,4	6	5	3,3	1,2													
11	9,5	8	6,5	5,2	2,7	0,5												
12	12	11,7	10,7	9,5	8	6,4	4,5	2,2										
6	5,5	4,7	3	2,5	0,6													
8	7,4	6	5	3,3	1,2													
11	9,5	8	6,5	5,2	2,7	0,5												
	4	3,5	3,2	2,5	1,7	0,8												
	6	6	5,9	5,4	4,1	3	1,8											
	8	8	8	7,6	6,2	5	3,8	2										
	10	10	10	9,7	8,3	6,4	5,5	3,5										
	12	12	12	11,5	10	8,8	7,3	5,3	3,6	2								
	15	15	15	14,7	12,8	11,4	9,7	7,8	6	4								
	18	17,7	16,8	14,9	13	11,5	10	7,9	6,1	4,3								
			4	3,6	3,1	2,6	2,1	1,5	0,9									
			6	6	5,4	4,8	4,1	3,2	2,5	1,7								
			8	7,4	6,7	6	5,3	4,3	3,6	2,7	1,8							
			10	9,5	8,5	7,6	6,8	5,5	5,3	3,7	2,8	2,2						
			11,8	11	10	9	8	7	6	5	4	3	2					
			13,5	12,5	11,5	10,5	9,6	8,2	7,2	6	5,1	4	2,8					
			14,8	14	13	12	10,9	9,7	8,8	7,5	6,5	5,2	4	3,1				
				4	3,8	3,4	3	2,5	2	1,5	0,8							
				6	6	5,9	5,4	4,7	4	3,5	2,8	2,2	1,6					
				8	8	7,5	6,8	6	5,5	4,8	4,1	3,5	2,8	2,2				
				10	9,8	9	8,4	7,5	6,8	6,2	5,3	4,7	4	3,2				
				12	11,4	11	10	9	8	7,3	6,7	6	5,3	4,6	3			
				15,2	15,1	15	14,8	14	13,2	12	11,3	10,4	9,8	8,7	7			
								4	3,6	3,2	2,7	2,3	1,8	1,5				
								6	5,8	5,3	4,8	4,1	3,5	3	2			
								8	7,5	6,8	6	5,4	4,9	4,3	3,1			
								10	10	10	9,4	8,2	7,8	7	5,6	2,9		
								12	12	12	11	10	9,1	8,5	6,8	4,3		
												4	3,6	3,2	2			
												6	5,5	4,8	3,8	1,5		
												8	7,9	7	5,9	3,2	2,1	
												10	9,8	9	7,8	4,7	3,5	0,8
												12,2	11,2	10,5	8,8	5,8	4,8	1,8

EVOSTA-2

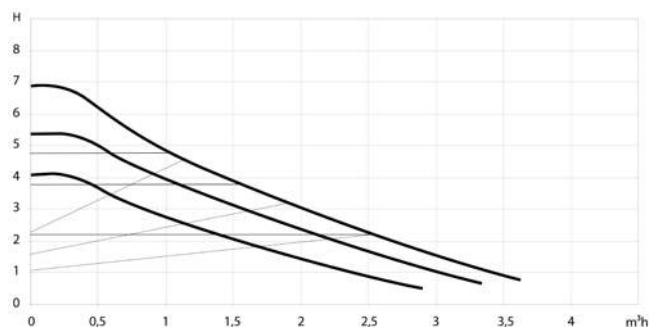

Aplicaciones:

Bomba de recirculación de agua caliente para instalaciones domésticas de calefacción centralizadas, de tipo cerrado y presurizado, o de vaso abierto; que gracias al **variador de frecuencia incorporado**, proporciona una gran eficiencia en términos de ahorro energético.

Características constructivas:

Cuerpo motor en fundición de hierro, carcasa motor en aluminio, turbina en tecnopolímero, eje-rotor y camisa protección del rotor en acero inoxidable, anillo en cerámica y anillo cierre en etileno propileno.

Motor:

Motor síncrono de imanes permanentes, regulado mediante variador de frecuencia.

Voltaje de alimentación: Monofásico 230V 50/60Hz

Campo de prestaciones: 0,4 - 3,6 m³/h con alturas hasta 6,9 metros

Campo de temperatura del líquido: de -10°C a +110°C

Líquido bombeado: Limpio y libre de sustancias sólidas, no viscoso, químicamente neutro.

Grado de protección y aislamiento: IP44 - Clase F

Racores no incluidos.



Applications:

Circulation pump for domestic hot water central heating, sealed and pressurized type, or open tank, thanks to **built-in frequency inverter**, provides a great efficiency in terms of energy saving.

Constructive characteristics:

Motor housing in cast iron, aluminum motor housing, techno polymer impeller, shaft-rotor and rotor protection sleeve in stainless steel, ceramic ring and ring closure of ethylene and propylene.

Motor:

Permanent magnet synchronous motor, controlled by frequency inverter.

Supply Voltage: Single phase 230V 50/60Hz

Performance field: 0 to 3 m³/h with heights up to 6.9 meters

Liquid temperature range: +2 °C to +95 °C

Pumped liquid: clean, free from solid substances, not viscous, chemically neutral.

Protection and insulation: IP44 - Class F

Racords not included.

Tipo Type	Distancia Distance mm.	Rácores Connections	Datos Eléctricos			Presión Mínima Minimum pressure	Peso Weight Kg.
			Voltaje V	P1 W	Int. A		
EVOSTA-2 40-70/130 (1/2")	130	1/2" F	1 x 230V	2 - 35	0,04 - 0,32	1 bar	1,8
EVOSTA-2 40-70/130	130	1" F					2
EVOSTA-2 40-70/180	180	1" F					2,2

EVOSTA-3



Aplicaciones:

Bomba de recirculación de agua caliente para instalaciones domésticas de calefacción centralizadas, de tipo cerrado y presurizado, o de vaso abierto; que gracias al **variador de frecuencia incorporado**, proporciona una gran eficiencia en términos de ahorro energético.

Características constructivas:

Cuerpo motor en fundición de hierro, carcasa motor en aluminio, turbina en tecnopolímero, eje-rotor y camisa protección del rotor en acero inoxidable, anillo en cerámica y anillo cierre en etileno propileno.

Motor:

Motor síncrono de imanes permanentes, regulado mediante variador de frecuencia.

Voltaje de alimentación: Monofásico 230V 50/60Hz

Campo de prestaciones: 0,4 a 3,3 m³/h con alturas hasta 8 metros.

Campo de temperatura del líquido: de -10°C a +110°C

Líquido bombeado: Limpio y libre de sustancias sólidas, no viscoso, químicamente neutro. Cantidad máxima de 30% de glicol.

Grado de protección y aislamiento: IP44 - Clase F

Racores no incluidos.



Applications:

Circulation pump for domestic hot water central heating, sealed and pressurized type, or open tank, thanks to **built-in frequency inverter**, provides a great efficiency in terms of energy saving.

Constructive characteristics:

Motor housing in cast iron, aluminum motor housing, techno polymer impeller, shaft-rotor and rotor protection sleeve in stainless steel, ceramic ring and ring closure of ethylene and propylene.

Motor:

Permanent magnet synchronous motor, controlled by frequency inverter.

Supply Voltage: Single phase 230V 50/60Hz

Performance field: 0.4 to 4.2 m³/h with heights up to 8 meters.

Liquid temperature range: -10 °C to +110 °C

Pumped liquid: clean, free from solid substances, not viscous, chemically neutral. Maximum 30% glycol.

Protection and insulation: IP44 - Class F

Records not included.

EVOSTA-3

EVOSTA-3 40

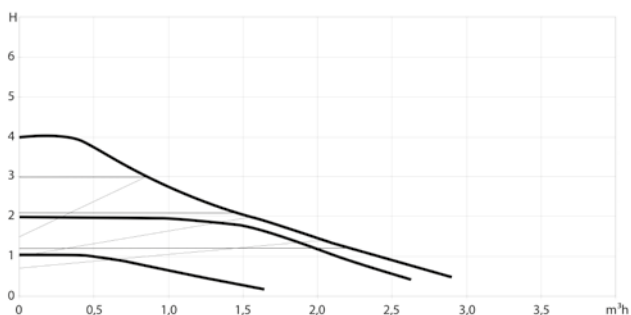

EVOSTA-3 60

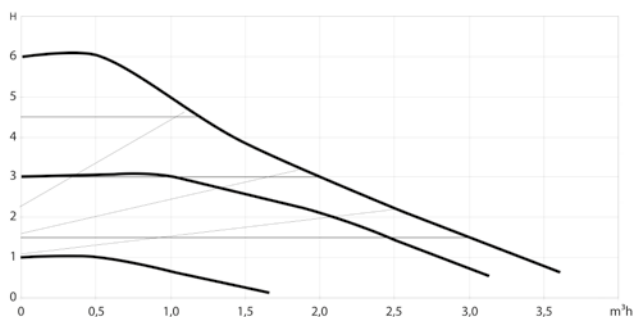

EVOSTA-3 80

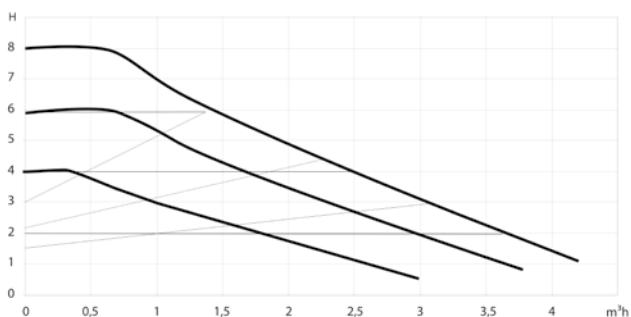

Tipo Type	Distancia Distance mm.	Rácores Connections	Datos Eléctricos			Presión Mínima Minimum pressure	Peso Weight Kg.
			Voltaje V	P1 W	Int. A		
EVOSTA-3 40/130 M	130	1" F	1 x 230V	2 - 20	0,034 - 0,18	1 bar	2
EVOSTA-3 40/180 M	180	1" F					2,2
EVOSTA-3 60/130 M	130	1" F	1 x 230V	3 - 35	0,042 - 0,33		2
EVOSTA-3 60/180 M	180	1" F					2,2
EVOSTA-3 60/180 XM	180	1 1/4" F					2,4
EVOSTA-3 80/130 M	130	1" F	1 x 230V	4 - 55	0,053 - 0,47		2
EVOSTA-3 80/180 M	180	1" F					2,2
EVOSTA-3 80/180 XM	180	1 1/4" F					2,4

EVOPLUS SMALL

pequeñas instalaciones colectivas
small collective facilities



Aplicaciones:

Bombas circulatoras electrónicas, que pueden ser utilizadas para calefacción, ventilación y sistemas de aire acondicionado en colegios, comunidades de vecinos, etc... Gracias al **variador de frecuencia incorporado**, reducen considerablemente el ruido en la instalación así como los costes de funcionamiento, proporcionando una gran eficiencia en términos de ahorro energético.

Características constructivas:

Cuerpo motor en fundición de hierro, carcasa motor en aluminio, turbina en tecnopolímero, eje-rotor y camisa protección del rotor en acero inoxidable, anillo en cerámica y anillo cierre en etileno propileno.

Motor:

Motor síncrono de imanes permanentes, regulado mediante variador de frecuencia.

Voltaje de alimentación: Monofásico 230V 50/60Hz

Campo de prestaciones: 0,5 a 18 m³/h con alturas hasta 12 metros

Campo de temperatura del líquido: de -10°C a +110°C

Líquido bombeado: Limpio y libre de sustancias sólidas, no viscoso, químicamente neutro. Cantidad máxima de 30% de glicol.

Grado de protección y aislamiento: IP44 – Clase F

Racores no incluidos.

Admite bajo demanda el módulo básico multifunción para control 0-10V.



Applications:

Electronic circulation pumps, which can be used for heating, ventilation and air conditioning systems in schools, condominiums, etc. Thanks to the **built-in frequency inverter**, reduces significantly the noise in the installation and reduces the operation costs, providing a great efficiency in terms of energy saving.

Constructive characteristics:

Motor housing in cast iron, aluminum motor housing, techno polymer impeller, shaft-rotor and rotor protection sleeve in stainless steel, ceramic ring and ring closure of ethylene and propylene.

Motor:

Permanent magnet synchronous motor, controlled by inverter.

Supply Voltage: Single phase 230V 50/60Hz

Performance field: 0.5 to 18 m³/h with heights up to 12 meters

Liquid temperature range: -10 °C to +110 °C

Pumped liquid: clean, free from solid substances, not viscous, chemically neutral. Maximum 30% glycol.

Protection and insulation: IP44 - Class F

Racords not included.

Basic multifunction module for 0-10V is available on demand.

EVOPLUS SMALL

EVOPLUS 60/180 XM

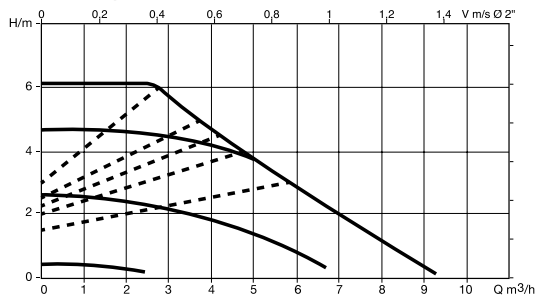

EVOPLUS 80/180 XM

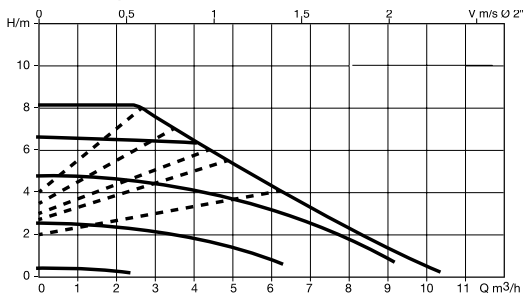

EVOPLUS 110/180 XM

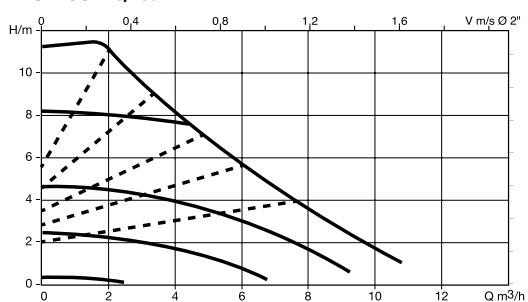

EVOPLUS B 40/220.32 M - EVOPLUS D 40/220.32 M

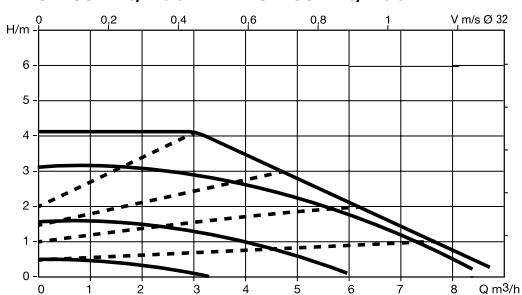

EVOPLUS B 60/220.32 M - EVOPLUS D 60/220.32 M

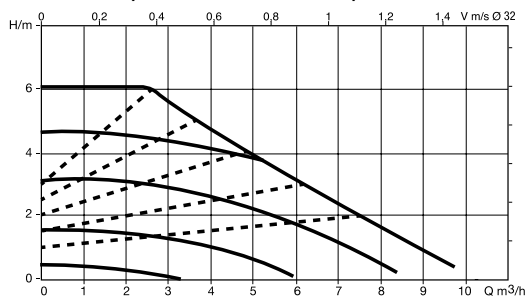

EVOPLUS B 80/220.32 M - EVOPLUS D 80/220.32 M

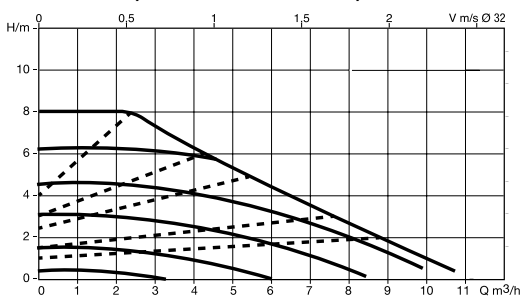

EVOPLUS B 110/220.32 M - EVOPLUS D 110/220.32 M

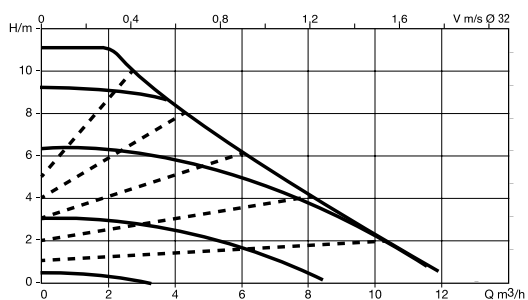

EVOPLUS B 120/220.32 M - EVOPLUS D 120/220.32 M

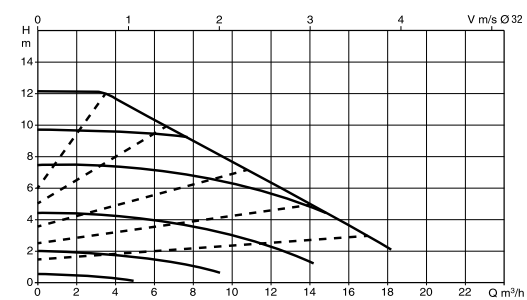

Las curvas representadas son las de VELOCIDAD CONSTANTE y PRESIÓN PROPORCIONAL.
 The curves shown are the CONSTANT SPEED and PROPORTIONAL PRESSURE.

EVOPLUS SMALL

EVOPLUS B 60/250.40 M - EVOPLUS D 60/250.40 M

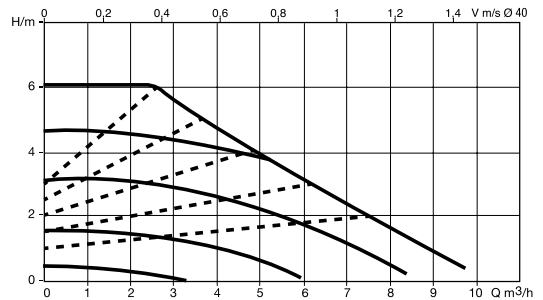

EVOPLUS B 80/250.40 M - EVOPLUS D 80/250.40 M

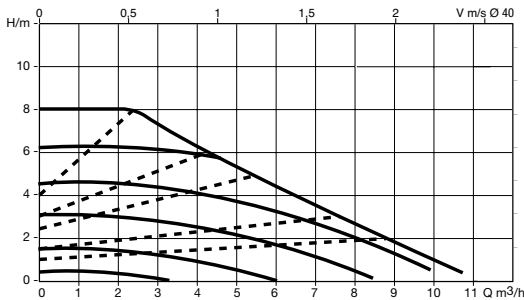

EVOPLUS B 110/250.40 M - EVOPLUS D 110/250.40 M

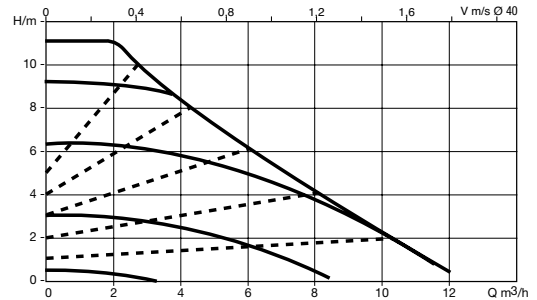

Las curvas representadas son las de VELOCIDAD CONSTANTE y PRESIÓN PROPORCIONAL.
The curves shown are the CONSTANT SPEED and PROPORTIONAL PRESSURE.

Tipo Type	Distancia Distance mm.	Rácores Connections	Datos Eléctricos			Presión Mínima Minimum pressure	Peso Weight Kg.				
			Voltaje V	P1 W	EEI max						
EVOPLUS 60/180 XM (SMALL)	180	1 1/4" F	1 x 230V	100	0,21	2 bar	2,8				
EVOPLUS 80/180 XM (SMALL)				135	0,21		2,8				
EVOPLUS 110/180 XM (SMALL)				170	0,21		2,8				
EVOPLUS B 40/220.32 M (SMALL)	220	DN 32 PN 6	1 x 230V	75	0,22	2 bar	6,9				
EVOPLUS B 60/220.32 M (SMALL)				105	0,22		6,9				
EVOPLUS B 80/220.32 M (SMALL)				140	0,22		6,9				
EVOPLUS B 110/220.32 M (SMALL)				190	0,22		6,9				
EVOPLUS B 120/220.32 M (SMALL)				340	0,22		14				
EVOPLUS D 40/220.32 M (D SMALL)				75	0,23		12,7				
EVOPLUS D 60/220.32 M (D SMALL)				105	0,23		12,7				
EVOPLUS D 80/220.32 M (D SMALL)				140	0,23		12,7				
EVOPLUS D 110/220.32 M (D SMALL)				190	0,23		12,7				
EVOPLUS D 120/220.32 M (D SMALL)				340	0,22		29				
EVOPLUS B 60/250.40 M (SMALL)				250	DN 40 PN 6		1 x 230V	105	0,21	2 bar	6,9
EVOPLUS B 80/250.40 M (SMALL)								140	0,21		6,9
EVOPLUS B 110/250.40 M (SMALL)	190	0,21	6,9								
EVOPLUS D 60/250.40 M (D SMALL)	100	0,22	12,7								
EVOPLUS D 80/250.40 M (D SMALL)	135	0,22	12,7								
EVOPLUS D 110/250.40 M (D SMALL)	190	0,22	12,7								

EVOPLUS



Aplicaciones:

Bombas circuladoras electrónicas, que pueden ser utilizadas para calefacción, ventilación y sistemas de aire acondicionado en edificios comerciales o residenciales, tales como hospitales, edificios de oficinas, etc... Gracias al **variador de frecuencia incorporado**, reducen considerablemente el ruido en la instalación así como los costes de funcionamiento, proporcionando una gran eficiencia en términos de ahorro energético.

Características constructivas:

Cuerpo motor en fundición de hierro, carcasa motor en aluminio, turbina en tecnopolímero, eje-rotor y camisa protección del rotor en acero inoxidable, anillo en cerámica y anillo cierre en etileno propileno.

Motor:

Motor síncrono de imanes permanentes, regulado mediante variador de frecuencia.

Voltaje de alimentación: Monofásico 230V 50/60Hz

Campo de prestaciones: 1 a 76 m³/h con alturas hasta 18 metros

Campo de temperatura del líquido: de -10°C a +110°C

Líquido bombeado: Limpio y libre de sustancias sólidas, no viscoso, químicamente neutro. Cantidad máxima de 30% de glicol.

Grado de protección y aislamiento: IP44 - Clase F

Incorpora el módulo multifunción para control 0-10V.



Applications:

Electronic circulation pumps, which can be used for heating, ventilation and air conditioning systems in commercial or residential buildings, such as hospitals, office buildings, etc. Thanks to the **built-in frequency inverter**, reduces significantly the noise in the installation and reduces the operation costs, providing a great efficiency in terms of energy saving.

Constructive characteristics:

Motor housing in cast iron, aluminum motor housing, techno polymer impeller, shaft-rotor and rotor protection sleeve in stainless steel, ceramic ring and ring closure in ethylene propylene.

Motor:

Permanent magnet synchronous motor, controlled by inverter.

Supply Voltage: Single phase 230V 50/60Hz

Performance field: 1 to 76 m³/h with heights up to 18 meters

Liquid temperature range: -10 °C to +110 °C

Pumped liquid: clean, free from solid substances, not viscous, chemically neutral. Maximum 30% glycol.

Protection and insulation: IP44 - Class F

Includes the 0-10V control multifunction module.

EVOPLUS

EVOPLUS B 40/220.40 M - EVOPLUS D 40/220.40 M

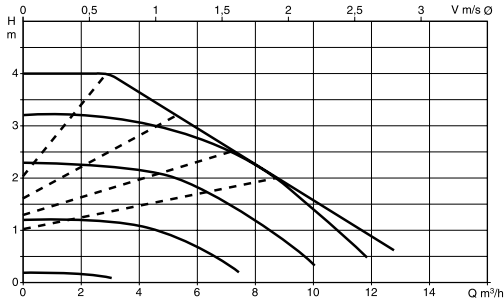

EVOPLUS B 60/220.40 M - EVOPLUS D 60/220.40 M

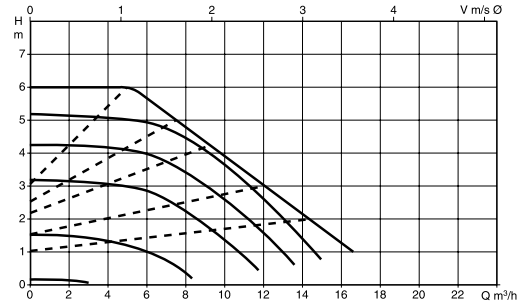

EVOPLUS B 80/220.40 M - EVOPLUS D 80/220.40 M

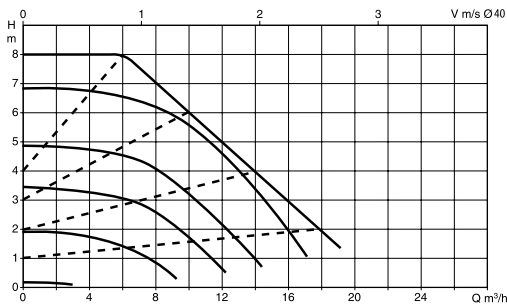

EVOPLUS B 100/220.40 M - EVOPLUS D 100/220.40 M

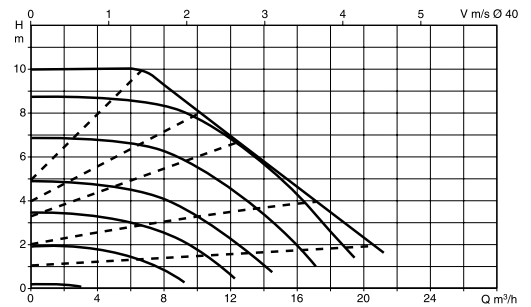

EVOPLUS B 120/250.40 M - EVOPLUS D 120/250.40 M

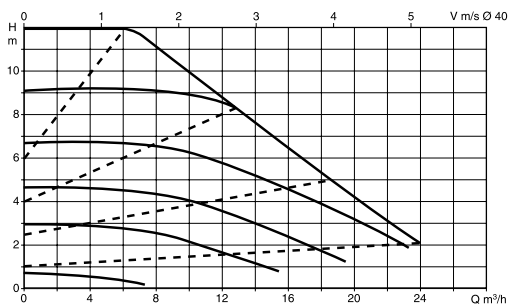

EVOPLUS B 150/250.40 M - EVOPLUS D 150/250.40 M

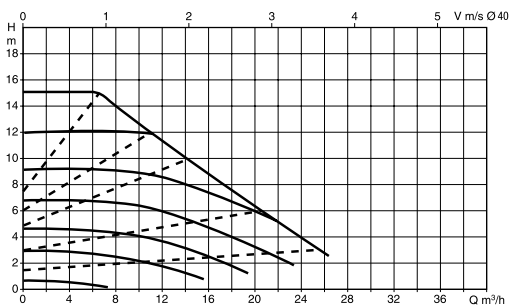

EVOPLUS

EVOPLUS B 180/250.40 M - EVOPLUS D 180/250.40 M

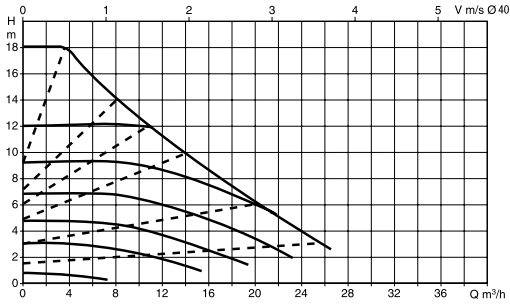

EVOPLUS B 40/240.50 M - EVOPLUS D 40/240.50 M

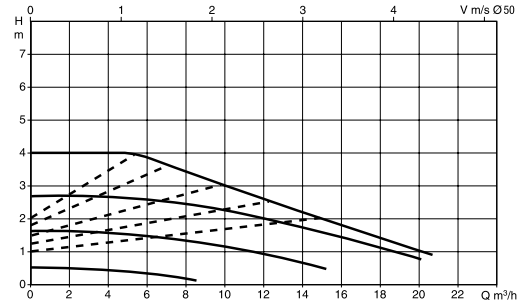

EVOPLUS B 60/240.50 M - EVOPLUS D 60/240.50 M

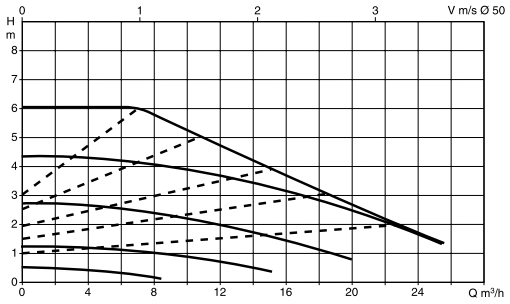

EVOPLUS B 80/240.50 M - EVOPLUS D 80/240.50 M

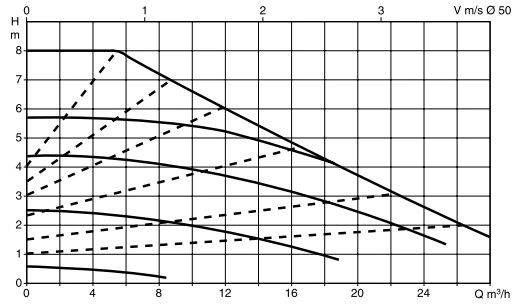

EVOPLUS B 100/280.50 M - EVOPLUS D 100/280.50 M

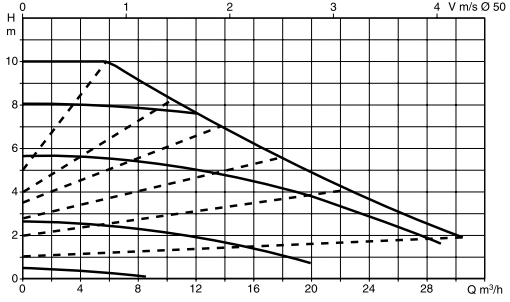

EVOPLUS B 120/280.50 M - EVOPLUS D 120/280.50 M

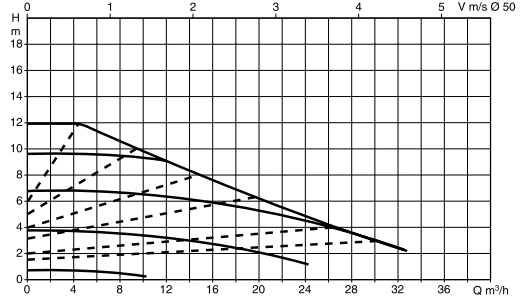

EVOPLUS

EVOPLUS B 150/280.50 M - EVOPLUS D 150/280.50 M

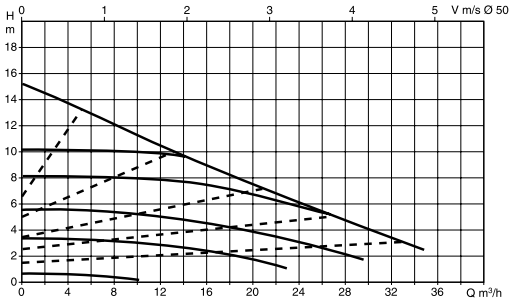

EVOPLUS B 180/280.50 M - EVOPLUS D 180/280.50 M

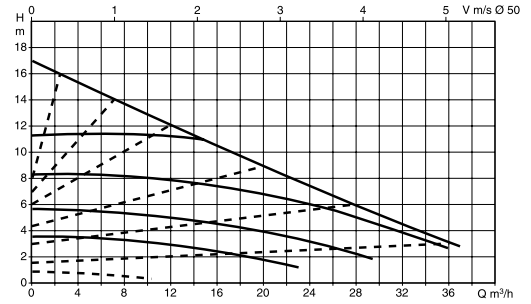

EVOPLUS B 40/340.65 M - EVOPLUS D 40/340.65 M

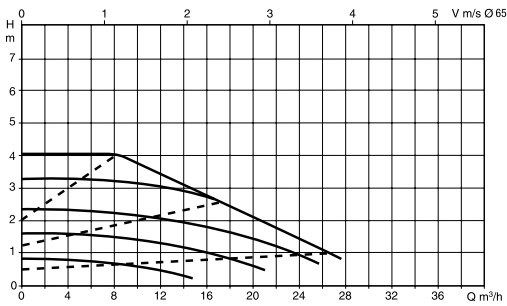

EVOPLUS B 60/340.65 M - EVOPLUS D 60/340.65 M

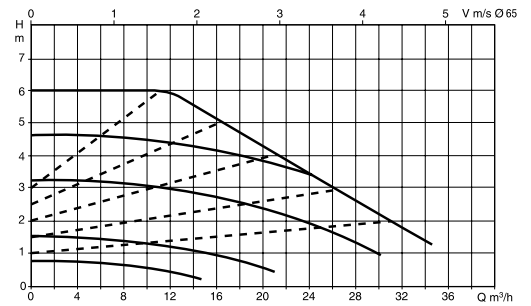

EVOPLUS B 80/340.65 M - EVOPLUS D 80/340.65 M

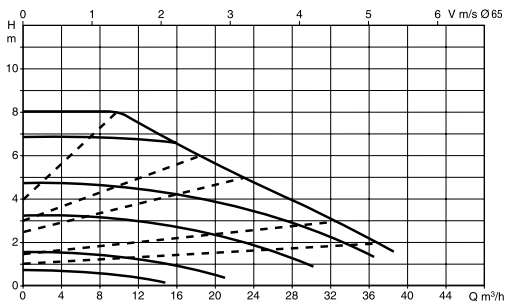

EVOPLUS B 100/340.65 M - EVOPLUS D 100/340.65 M

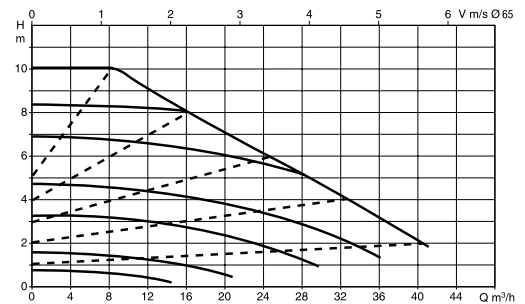

EVOPLUS

EVOPLUS B 120/340.65 M - EVOPLUS D 120/340.65 M

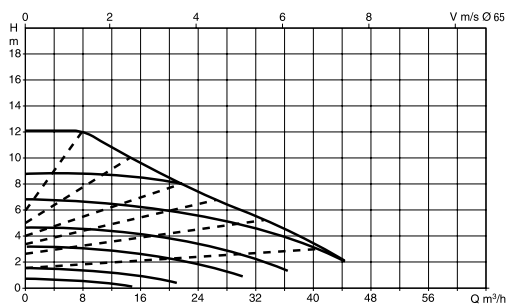

EVOPLUS B 150/340.65 M - EVOPLUS D 150/340.65 M

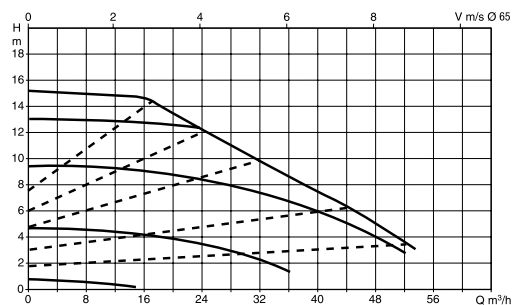

EVOPLUS B 40/360.80 M - EVOPLUS D 40/360.80 M

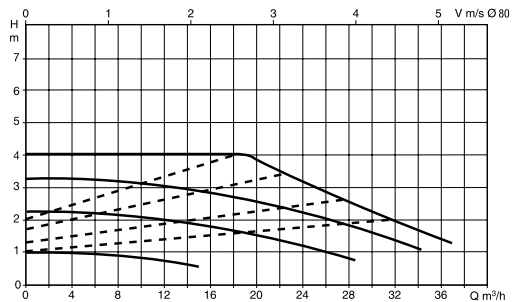

EVOPLUS B 60/360.80 M - EVOPLUS D 60/360.80 M

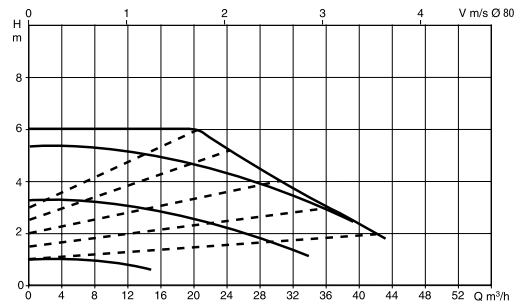

EVOPLUS B 80/360.80 M - EVOPLUS D 80/360.80 M

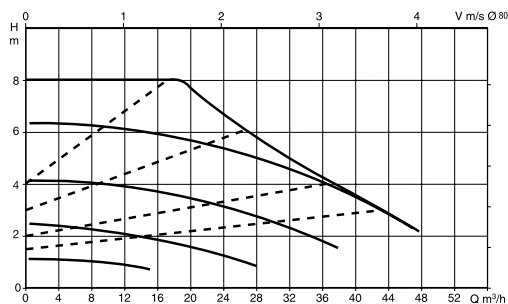

EVOPLUS B 100/360.80 M - EVOPLUS D 100/360.80 M

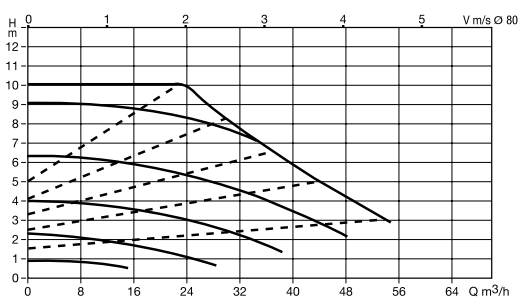

EVOPLUS

EVOPLUS B 120/360.80 M - EVOPLUS D 120/360.80 M

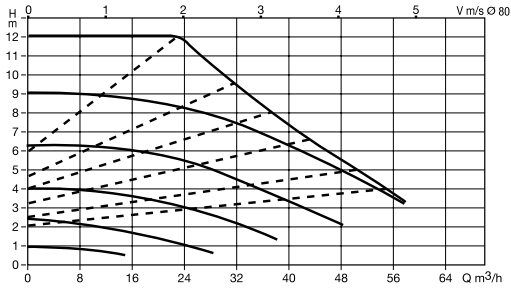

EVOPLUS B 40/450.100 M - EVOPLUS D 40/450.100 M

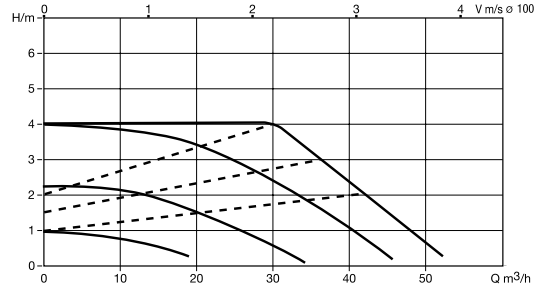

EVOPLUS B 60/450.100 M - EVOPLUS D 60/450.100 M

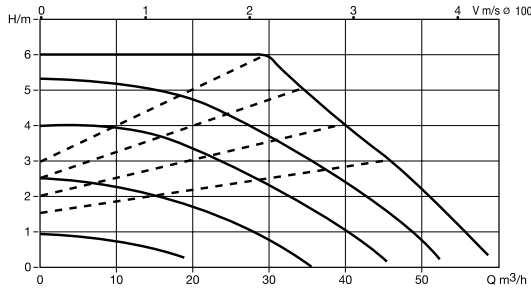

EVOPLUS B 80/450.100 M - EVOPLUS D 80/450.100 M

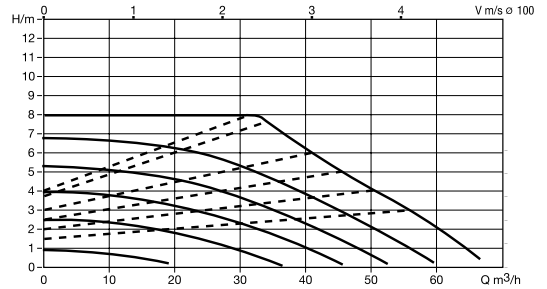

EVOPLUS B 100/450.100 M - EVOPLUS D 100/450.100 M

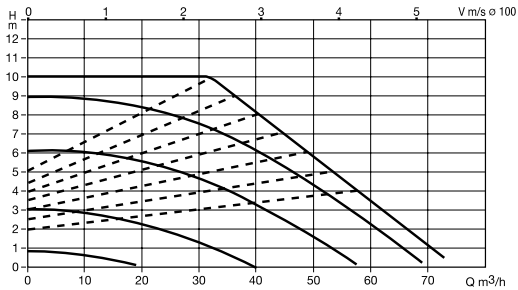

EVOPLUS B 120/450.100 M - EVOPLUS D 120/450.100 M

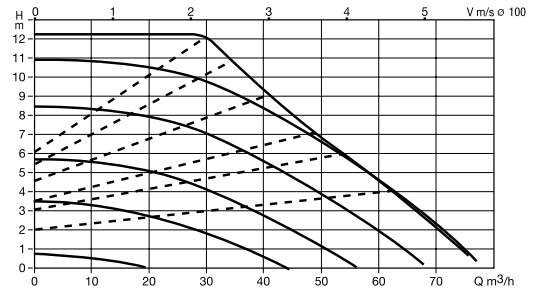

Tipo <i>Type</i>	Distancia <i>Distance</i> mm.	Rácores <i>Connections</i>	Datos Eléctricos			Presión Mínima <i>Minimum</i> pressure	Peso <i>Weight</i> Kg.			
			Voltaje V	P1 W	EEI max					
EVOPLUS B 40/220.40 M	220	DN 40 PN 10	1 x 230V	90	0,24	2 bar	15,5			
EVOPLUS B 60/220.40 M	220			175	0,23		15,5			
EVOPLUS B 80/220.40 M	220			260	0,21		15,5			
EVOPLUS B 100/220.40 M	220			350	0,20		15,5			
EVOPLUS B 120/250.40 M	250			465	0,20		16			
EVOPLUS B 150/250.40 M	250			610	0,20		16			
EVOPLUS B 180/250.40 M	250			610	0,20		16			
EVOPLUS B 40/240.50 M	240			DN 50 PN 10	1 x 230V		140	0,23	2 bar	17
EVOPLUS B 60/240.50 M	240	260	0,21			17				
EVOPLUS B 80/240.50 M	240	330	0,21			17				
EVOPLUS B 100/280.50 M	280	430	0,20			18				
EVOPLUS B 120/280.50 M	280	530	0,19			18				
EVOPLUS B 150/280.50 M	280	640	0,19			18				
EVOPLUS B 180/280.50 M	280	750	0,19			18				
EVOPLUS B 40/340.65 M	340	DN 65 PN 10	1 x 230V			190	0,21	2 bar		20
EVOPLUS B 60/340.65 M	340			355	0,20	20				
EVOPLUS B 80/340.65 M	340			465	0,19	20				
EVOPLUS B 100/340.65 M	340			590	0,18	20				
EVOPLUS B 120/340.65 M	340			730	0,18	20				
EVOPLUS B 150/340.65 M	340			1210	0,18	20				
EVOPLUS B 40/360.80 M	360			DN 80 PN 10	1 x 230V	330	0,19		2 bar	25
EVOPLUS B 60/360.80 M	360					535	0,20			25
EVOPLUS B 80/360.80 M	360	670	0,20			25				
EVOPLUS B 100/360.80 M	360	1005	0,19			25				
EVOPLUS B 120/360.80 M	360	1235	0,19			25				
EVOPLUS B 40/450.100 M	450	DN 100 PN 10	1 x 230V	530	0,19	2 bar	30			
EVOPLUS B 60/450.100 M	450			760	0,18		30			
EVOPLUS B 80/450.100 M	450			1080	0,18		30			
EVOPLUS B 100/450.100 M	450			1380	0,19		30			
EVOPLUS B 120/450.100 M	450			1560	0,19		30			
EVOPLUS D 40/220.40 M	220	DN 40 PN 10	1 x 230V	90	0,25	2 bar	31			
EVOPLUS D 60/220.40 M	220			175	0,25		31			
EVOPLUS D 80/220.40 M	220			260	0,25		31			
EVOPLUS D 100/220.40 M	220			350	0,25		31			
EVOPLUS D 120/250.40 M	250			465	0,23		32			
EVOPLUS D 150/250.40 M	250			610	0,23		32			
EVOPLUS D 180/250.40 M	250			610	0,23		32			
EVOPLUS D 40/240.50 M	240			DN 50 PN 10	1 x 230V		140	0,23	2 bar	33
EVOPLUS D 60/240.50 M	240	260	0,22			33				
EVOPLUS D 80/240.50 M	240	330	0,22			33				
EVOPLUS D 100/280.50 M	280	430	0,22			34				
EVOPLUS D 120/280.50 M	280	530	0,22			34				
EVOPLUS D 150/280.50 M	280	640	0,21			34				
EVOPLUS D 180/280.50 M	280	750	0,21			34				
EVOPLUS D 40/340.65 M	340	DN 65 PN 10	1 x 230V			190	0,21	2 bar		37
EVOPLUS D 60/340.65 M	340			355	0,21	37				
EVOPLUS D 80/340.65 M	340			465	0,21	37				
EVOPLUS D 100/340.65 M	340			590	0,20	37				
EVOPLUS D 120/340.65 M	340			730	0,20	37				
EVOPLUS D 150/340.65 M	340			1210	0,20	37				
EVOPLUS D 40/360.80 M	360			DN 80 PN 10	1 x 230V	330	0,20		2 bar	44
EVOPLUS D 60/360.80 M	360					535	0,20			44
EVOPLUS D 80/360.80 M	360	670	0,20			44				
EVOPLUS D 100/360.80 M	360	1005	0,19			44				
EVOPLUS D 120/360.80 M	360	1235	0,19			44				
EVOPLUS D 40/450.100 M	450	DN 100 PN 10	1 x 230V	530	0,19	2 bar	53			
EVOPLUS D 60/450.100 M	450			760	0,19		53			
EVOPLUS D 80/450.100 M	450			1080	0,20		53			
EVOPLUS D 100/450.100 M	450			1380	0,20		53			

VS



Aplicaciones:

Bomba de circulación para instalaciones de agua caliente sanitaria de tipo cerrado o a vaso abierto.

Características constructivas:

Cuerpo Bomba en bronce, carcasa motor en aluminio, turbina en tecnopolímero, eje rotor, camisa de protección del rotor y disco cierre en acero inoxidable.

Anillo en cerámica y anillo sello en etileno-propileno.

Motor, asíncrono de rotor húmedo sin sello mecánico.

Rotor montado sobre cojinetes en grafito.

Campo de prestaciones: de 0,5 a 5m³/h hasta 6,5 m.c.a.

Campo de temperatura del líquido: +2° C a +110° C.

Líquido bombeado:

Limpio, libre de sustancias sólidas, no viscoso, no cristalizado y neutro.

Máxima presión de ejercicio: 10 bar (1000K Pa).

Mínima presión de ejercicio:

valores a Q máx. y temp. del líquido a +90° C: 2,5 mts.

Grado de protección: IP-41

Clase de aislamiento: F.

Racores no incluidos.



Applications:

Pump for circulating hot domestic water in closed and pressurised or open tank systems.

Also suitable for solar power systems.

Constructive characteristics:

Single body comprising bronze hydraulic unit and wet rotor motor. Die-cast aluminium motor casing. Technopolymer impeller. Ceramic driving shaft mounted on graphite bearings lubricated by the pumped liquid. Stainless steel protective rotor sleeve, stator sleeve and closing flange. Ceramic thrust bearing, E.P.D.M. O-rings and brass air outlet cap.

Two or four pole asynchronous motor with squirrel cage rotor. Motor self-protected against resistance. No overload protection required.

Protection level: IP 44. Insulating class: F

Rated voltage: single-phase 230 V / 50 Hz

Racors not included.

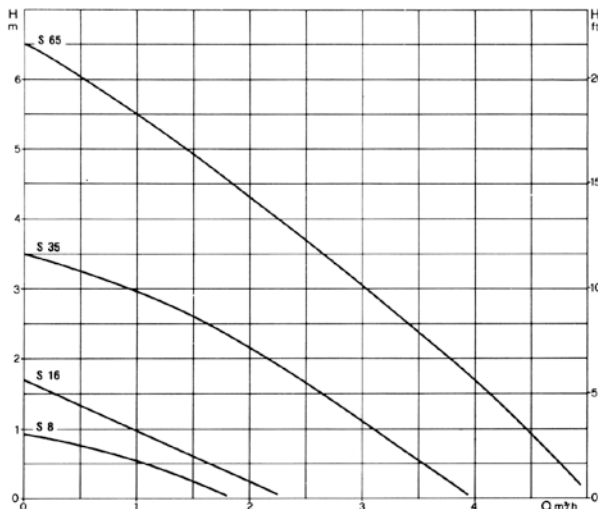

Tipo Type	Alimentación 50 HZ	Rácores	Datos Eléctricos				Entre Ejes mm.	Peso Kg.
			r.p.m. 1/min.	P1 máx W	Cons. A	Cond. µF		
VS 8-150	1 x 230 V~	1" Latón	1400	22	0,26	2,5	150	3,1
VS 16-150	1 x 230 V~		1400	41	0,35	2	150	3,5
VS 35-150	1 x 230 V~		2680	56	0,32	2	150	3,1
VS 65-150	1 x 230 V~		2680	78	0,58	3	150	3,1

ROTOR SECO *DRY ROTOR*

MODELO		MODELO		P2 NOMINAL		Q	0	3,6	4,8	6	12
MONOFASICA SIMPLE	TRIFASICA SIMPLE	MONOFASICA GEMELA	TRIFASICA GEMELA	HP	KW						
-	CP 40/1900 T	-	-	1	0,8	17,6	17,6	17,4	17	14	
-	CP 40/2300 T	-	-	1,5	1,1	21,8	21,8	21,3	21	18	
-	CP 40/2700 T	-	-	2	1,5	26,9	26,9	26,7	26,2	23,2	
-	CP 40/3500 T	-	-	3	2,2	34,8	34,9	34,7	34,2	31,7	
-	CP 40/3800 T	-	-	4	3				38	35	
-	CP 40/4700 T	-	-	5,5	4				47	44	
-	CP 40/5500 T	-	-	7,5	5,5				55	53	
-	CP 40/6200 T	-	-	10	7,5				62	59	
-	CP 50/2200 T	-	-	1,5	1,1				20	16,5	
-	CP 50/2600 T	-	-	2	1,5				25	22	
-	CP 50/3100 T	-	-	3	2,2				31	28,5	
-	CP 50/4100 T	-	-	5,5	4				40,7	38,5	
-	CP 50/4600 T	-	-	7,5	5,5						
-	CP 50/5100 T	-	-	10	7,5						
-	CP 50/5650 T	-	-	10	7,5						
-	CP 65/1470 T	-	-	2	1,5	14,7			14,5	14,3	
-	CP 65/1900 T	-	-	3	2,2	19			18,7	18,4	
-	CP 65/2280 T	-	-	4	3	22,8			22,5	22,3	
-	CP 65/2640 T	-	-	5,5	4	26,4			26,2	26	
-	CP 65/3400 T	-	-	7,5	5,5	34					
-	CP 65/4100 T	-	-	10	7,5	41					
-	CP 65/4700 T	-	-	15	11	47					
-	CP 65/5500 T	-	-	20	15	55					
-	CP 65/6150 T	-	-	25	18,5	61,5					
-	CP 65/7350 T	-	-	30	22	73,5					
-	CP 65/9250 T	-	-	40	30	92,5					
-	CP 80/1400 T	-	-	3	2,2	14					
-	CP 80/1700 T	-	-	4	3	17					
-	CP 80/2050 T	-	-	5,5	4	20,5					
-	CP 80/2400 T	-	-	7,5	5,5	24					
-	CP 80/2770 T	-	-	10	7,5	27,7					
-	CP 80/3250 T	-	-	15	11	32,5					
-	CP 80/4000 T	-	-	20	15	40					
-	CP 80/5150 T	-	-	25	18,5	51,5					
-	CP 80/5650 T	-	-	30	22	56,5					
-	CP 80/6850 T	-	-	40	30	68,5					
-	CP 80/8600 T	-	-	50	37	86					
-	CP 80/9600 T	-	-	60	45	96					
-	CP 80/10200 T	-	-	75	55	102					
-	CP 100/1600 T	-	-	5,5	4	16					
-	CP 100/1950 T	-	-	7,5	5,5	19,5					
-	CP 100/2350 T	-	-	10	7,5	23,5					
-	CP 100/2400 T	-	-	15	11	24					
-	CP 100/3050 T	-	-	20	15	30,5					
-	CP 100/3550 T	-	-	25	18,5	35,5					
-	CP 100/3850 T	-	-	30	22	38,5					
-	CP 100/4800 T	-	-	40	30	48					
-	CP 100/5600 T	-	-	50	37	56					
-	CP 100/6300 T	-	-	60	45	63					
-	CP 100/8300 T	-	-	75	55	83					
-	CP 125/4750 T	-	-	50	37	46,5					
-	CP 125/5300 T	-	-	60	45	51,5					
-	CP 125/5800 T	-	-	75	55	57,5					

H
(m)

ALM-ALP

centrífugas circuladoras
circulating centrifugals



Aplicaciones: Bomba de circulación para instalaciones de calefacción, refrigeración y agua caliente sanitaria de tipo cerrado o a vaso abierto.

Características constructivas: Cuerpo bomba y soporte motor en fundición para ALM 500 - ALP 2000, en bronce para los modelos ALM 200 - ALP 800. Turbina en Tecnopolímero B, sello mecánico en carbón/cerámica. Eje Rotor en acero inoxidable. Motor IE3 de tipo asíncrono, cerrado y refrigerado a ventilación externa a 4 polos para las ALM y a 2 polos para las ALP. Protección Termoamperimétrica y condensador permanente incorporado en versión monofásica. Construcción SEGUN NORMATIVAS CEI. Campo de Prestaciones: de 2 a 8,5 m³/h. hasta 20 mts. Líquido de Bombeado: Limpio, sin sustancias sólidas, no viscoso, no cristalizado y químicamente neutro. Campo de Temperatura del líquido: de -15° C a + 120° C. Máxima Temperatura ambiente: + 40° C. Máxima Presión de Trabajo: 10 bar (1.000 Kpa). Grado de Protección: IP-44. Cuadro de Aislamiento: F. **Racores no incluidos.**



Applications: Circulation pump for hot or cold water in-line connections, suitable for installation in series directly to the piping in civil and industrial heating, conditioning and hot water plants.

Constructive characteristics: Pump body and motor support in cast iron for ALM 500 and ALP 2000, and in bronze for ALM 200 and ALP 800. Intake and delivery connection: 1" 1/2 M-GAS for ALM 200 and ALP 800 and 2" M-GAS for ALM 500 and ALP 2000. Technopolymer impeller. carbon/ceramic mechanical seal. Constructional features of the motor. IE3 induction motor, closed and cooled with external ventilation, four-pole for the ALM version and two-pole for the ALP version. Rotor mounted on oversized, greased-for-life ball bearings to guarantee silent running and long life. Manufactured according to: CEI 2-3 standards.

Racords not included.

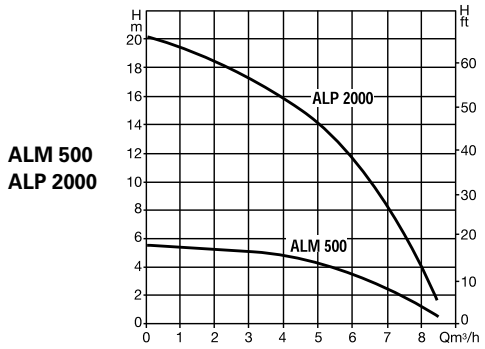
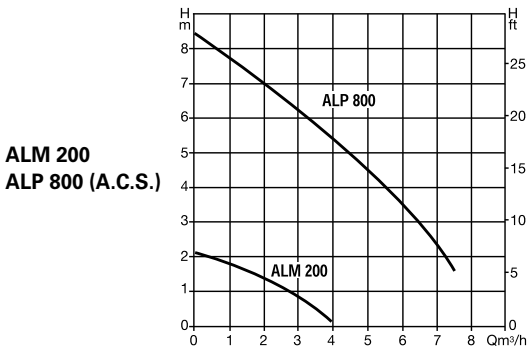

Tipo <i>Type</i>	Alimentación 50 HZ	Rácores	Datos Eléctricos						Entre Ejes mm.	Peso Kg.
			r.p.m. 1/min.	P1 máx W	P2 NOMINAL KW	HP	Cons. A	Cond. µF		
ALM 200 M	1 x 230 V~	1" F	1380	95	0,06	0,08	0,5	5	180	7
ALM 200 T	3 x 230/400 V~	1" F	1380	70	0,06	0,08	0,5-0,3	-	180	7
ALP 800 M	1 x 230 V~	1" F	2820	210	0,37	0,5	2,5	12,5	180	7
ALP 800 T	3 x 230/400 V~	1" F	2820	200	0,37	0,5	2-1,2	-	180	7
ALM 500 M	1 x 230 V~	1/4" F	1380	220	0,25	0,33	1,1	5	250	14
ALM 500 T	3 x 230/400 V~	1/4" F	1380	210	0,25	0,33	1,1-0,63	-	250	14
ALP 2000 M	1 x 230 V~	1/4" F	2820	750	0,55	0,75	3,8	16	250	14
ALP 2000 T	3 x 230/400 V~	1/4" F	2820	700	0,55	0,75	2,5-1,45	-	250	14

KLM KLP DKLM DKLP



Aplicaciones: Bomba de circulación para instalaciones de calefacción, refrigeración y agua caliente sanitaria de tipo cerrado o a vaso abierto.

Características constructivas: Cuerpo bomba y soporte motor en fundición. Turbina en tecnopolímero B, sello mecánico en carbón/cerámica. Eje rotor en acero inoxidable. Motor IE3 de tipo asíncrono, cerrado y refrigerado a ventilación externa a 4 polos para las KLM y a 2 polos para las KLP. Protección term-amperimétrica y

condensador permanente incorporado en versión monofásica. Construcción según Normativas CEI. **Campo de prestaciones:** de 2 a 70 m³/h hasta 12 mts. **Líquido bombeado:** Limpio, sin sustancias sólidas, no viscoso, no cristalizado y químicamente neutro. **Campo de temperatura del líquido:** de -15° C a + 120° C. **Máxima temperatura ambiente:** + 40° C. **Máxima presión de trabajo:** 10 bar (1000 Kpa). **Grado de protección:** IP 44 caja bornes IP 55 (DN 50-65-80). **Grado de aislamiento:** F.

Tipo Type	P1 (kW)	P2		A		uF	r.p.m	Bridas Flanges	Distancia Distance	Peso Weight Kg.
		kW	HP	230V (1~)	230/400V					
KLM-DKLM 40/300	0,23	0,25	0,33	1,15	1,1 - 0,63	5	1400	DN40 / PN 10	250	17-40
KLP-DKLP 40/600	0,55	0,37	0,5	2,6	1,9 - 1,1	10	2800	DN40 / PN 10	250	17-40
KLP-DKLP 40/900	0,6	0,37	0,5	2,8	2,1 - 1,2	10	2850	DN40 / PN 10	250	18-41
KLP-DKLP 40/1200	0,75	0,55	0,75	3,8	2,4 - 1,4	14	2850	DN40 / PN 10	250	18-41
KLP-DKLP 40/1600	0,96	0,75	1	4,7	3,7 - 2,1	20	2840	DN40 / PN 10	250	24-46
KLP-DKLP 40/1800	1,09	0,85	1,15	5,4	4 - 2,3	20	2840	DN40 / PN 10	250	25-46
KLM-DKLM 50/300	0,36	0,25	0,33	1,85	1,2 - 0,7	10	1370	DN50 / PN 10	280	24-44
KLM-DKLM 50/600	0,45	0,25	0,33	2,1	1,4 - 0,8	10	1370	DN50 / PN 10	280	26-51
KLP-DKLP 50/900	0,93	0,75	1	4,2	2,8 - 1,6	25	2800	DN50 / PN 10	280	27-52
KLP-DKLP 50/1200	1,1	0,75	1	5	3,3 - 1,9	25	2800	DN50 / PN 10	280	29-54
KLP-DKLP 50/1600	1,3	1	1,36	7,1	4,3 - 2,5	40	2840	DN50 / PN 10	280	27-55
KLP-DKLP 50/2000	2,3	1,84	2,5	11	7,6 - 4,4	40	2840	DN50 / PN 10	280	33-59
KLM-DKLM 65/300	0,4	0,25	0,33	-	1,4 - 0,8	-	1350	DN65 / PN 10	340	26-49
KLM-DKLM 65/600	0,55	0,37	0,5	-	2 - 1,15	-	1380	DN65 / PN 10	340	30-55
KLP-DKLP 65/900	1,05	1,1	1,5	-	3,8 - 2,2	-	2820	DN65 / PN 10	340	32-57
KLP-DKLP 65/1200	1,45	1,1	1,5	-	4,7 - 2,7	-	2820	DN65 / PN 10	340	34-61
KLP-DKLP 65/1600	2	1,65	2,25	-	6,5 - 3,8	-	2860	DN65 / PN 10	340	35-67
KLP-DKLP 65/2000	2,5	2	2,7	-	8,1 - 4,7	-	2830	DN65 / PN 10	340	38-73
KLM-DKLM 80/300	0,4	0,25	0,33	-	1,4 - 0,8	-	1350	DN80 / PN 10	360	32-47
KLM-DKLM 80/600	1	0,75	1	-	3,4 - 1,95	-	1400	DN80 / PN 10	360	36-63
KLP-DKLP 80/900	1,8	1,84	2,5	-	6,3 - 3,6	-	2820	DN80 / PN 10	360	38-68
KLP-DKLP 80/1200	2,4	1,84	2,5	-	7,6 - 4,4	-	2820	DN80 / PN 10	360	42-75
KLP-DKLP 80/1600	3,2	2,5	3,5	-	10,3 - 6	-	2800	DN80 / PN 10	360	42-82
KLP-DKLP 80/2000	4,7	3,7	5	-	14 - 8,1	-	2870	DN80 / PN 10	360	48-94

KLM KLP DKLM DKLP



Applications: Circulation pump for hot or cold water in-line connections, suitable for installation in series directly to the piping in civil and industrial heating, conditioning and hot water plants.

Constructive characteristics: Pump body and motor support in cast iron. Flanged suction and delivery connections in PN 10 with threaded holes for control pressure gauges. This range can also accept counterflanges in PN 6 in order to facilitate pump interchange in existing installations. Technopolymer impeller. Carbon/ceramic mechanical seal. The twin version allows the pumps to be used alternately where a backup unit is required or used simultaneously.

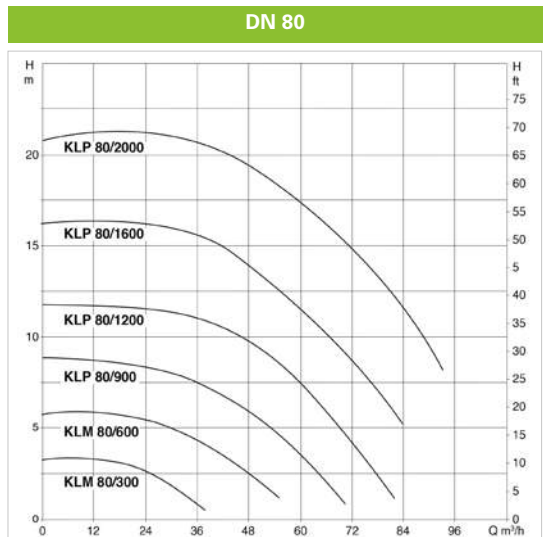
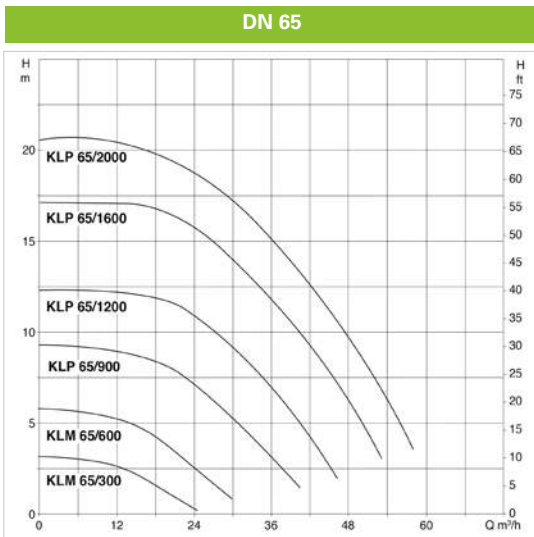
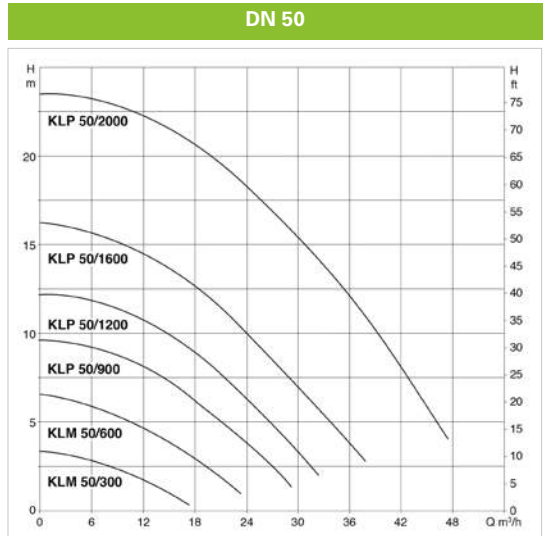
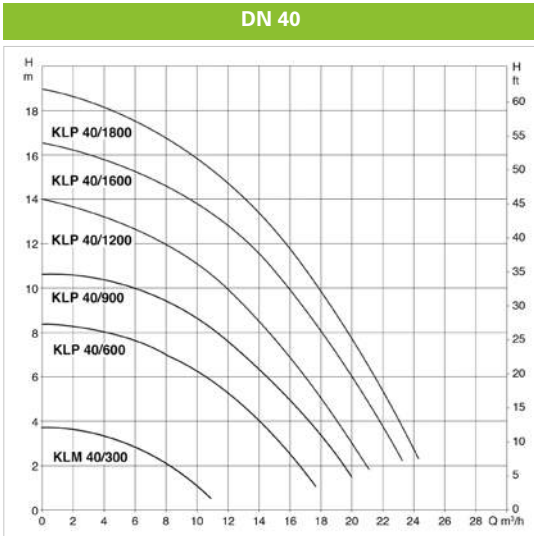

CM



Aplicaciones:

Bomba de circulación para instalaciones de calefacción, refrigeración y agua caliente sanitaria de tipo cerrado o a vaso abierto.

Características constructivas:

Cuerpo bomba, soporte motor, turbina y tapa ventilador en fundición.

De SERIE con contrabridas.

Sello mecánico en carbón/cerámica.

Eje Rotor en acero inoxidable.

Motor IE3 de tipo asíncrono, cerrado y refrigerado a ventilación externa a 4 polos.

CONSTRUCCIÓN SEGUN NORMATIVAS CEI.

Campo de Prestaciones: de 6 a 420 m³/h hasta 41 mts.

Líquido Bombeado: Limpio, sin sustancias sólidas, no viscoso, no cristalizado y químicamente neutro.

Campo de Temperatura del líquido: de -15° C a + 120° C.

Máxima Temperatura ambiente: + 40° C.

Máxima Presión de Trabajo: 16 bar (1.600 Kpa).

Grado de Protección: IP-44 caja bornes IP-55.

Grado de Aislamiento: F.



Applications:

Circulating pump with in-line connections, suitable for civil and industrial heating, conditioning, refrigeration and hot water for plumbing.

Constructive characteristics:

Body and support in cast iron. Cast iron impeller for all models from CM 65 to CM 150 and in tephnopolymer for models from CM 40 to CM 50. Flanged suction and delivery connections in PN 16 with threaded holes for control pressure gauges. Carbon/ceramic seal.

Motor:

Four-pole IE3 induction motor, closed and cooled with external ventilation. Rotor mounted on oversized, greased-for-life ball bearings to guarantee silent running and long life.

CM - 40

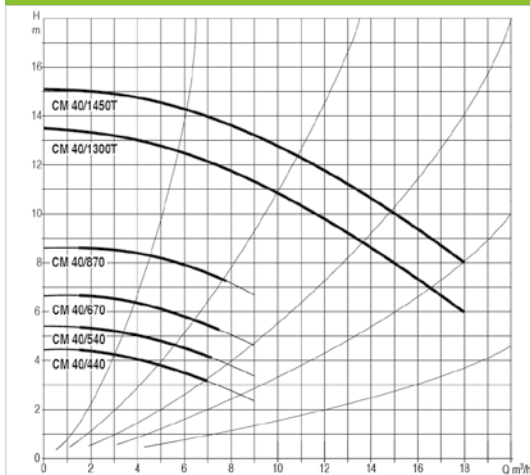

CM - 50

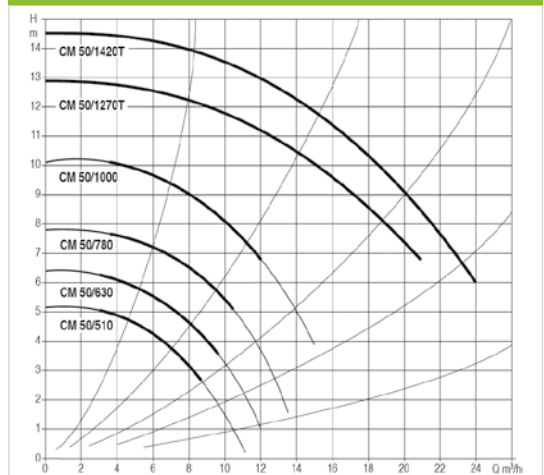

CM

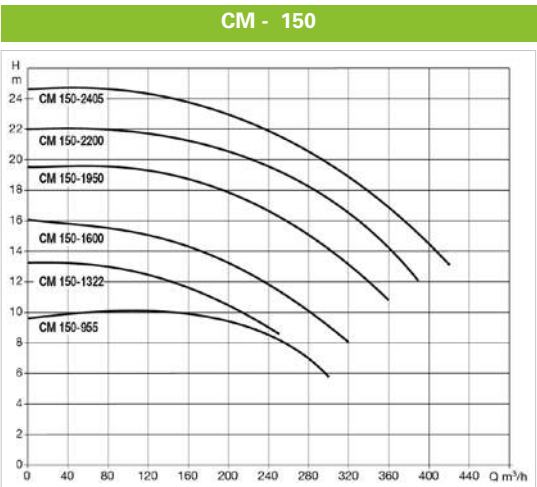
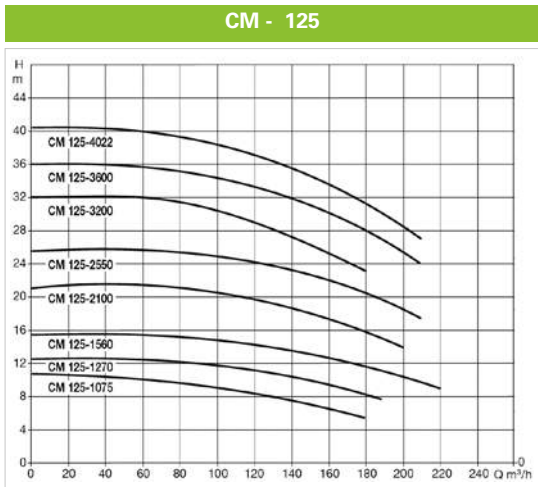
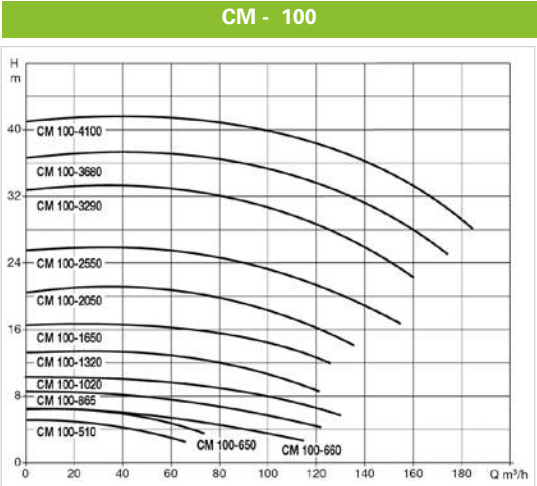
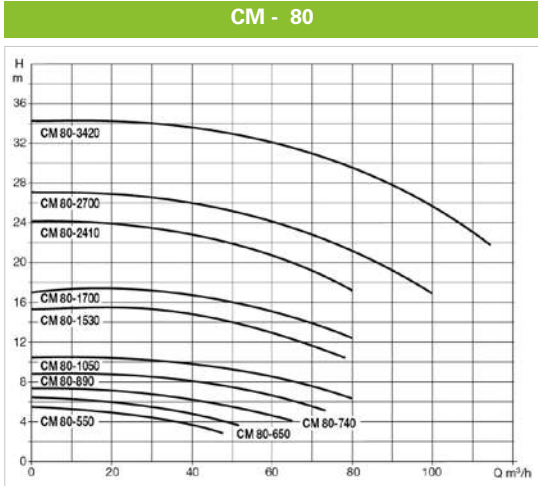
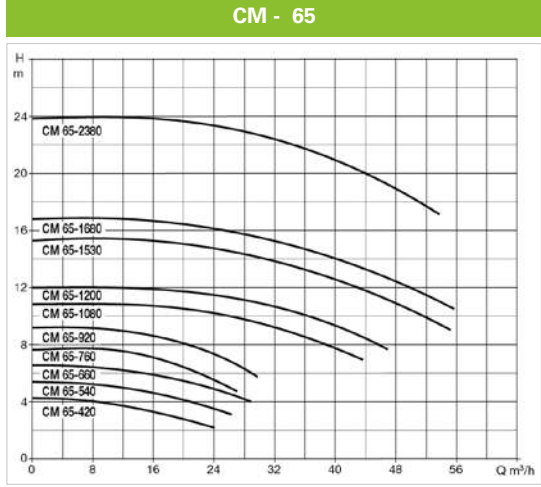

CM

Tipo <i>Type</i>	Alimentación 50 HZ	BRIDAS	Datos Eléctricos					Entre Ejes mm.	Peso Kg.
			r.p.m. 1/min.	P1 máx kW	P2 NOMINAL HP	kW	Cons. A		
CM 40/440 T	3 x 230/400 V	DN 40	1480	0,28	1	0,75	2,1 - 1,2	390	35,3
CM 40/540 T	3 x 230/400 V	DN 40	1480	0,33	1	0,75	2,1 - 1,2	390	35,8
CM 40/670 T	3 x 230/400 V	DN 40	1480	0,39	1	0,75	2,2 - 1,3	390	35,1
CM 40/870 T	3 x 230/400 V	DN 40	1480	0,59	1	0,75	2,2 - 1,3	390	36,9
CM 40/1300 T	3 x 230/400 V	DN 40	1450	1,1	1	0,75	3,5 - 2	380	30
CM 40/1450 T	3 x 230/400 V	DN 40	1450	1,2	1,3	1	4,2 - 2,4	380	30
CM 50/510 T	3 x 230/400 V	DN 50	1480	0,35	1	0,75	2,1 - 1,2	425	39
CM 50/630 T	3 x 230/400 V	DN 50	1480	0,5	1	0,75	2,2 - 1,3	425	39
CM 50/780 T	3 x 230/400 V	DN 50	1470	0,5	1	0,75	2,2 - 1,3	425	38,6
CM 50/1000 T	3 x 230/400 V	DN 50	1470	0,64	1	0,75	2,4 - 1,4	425	38,5
CM 50/1270 T	3 x 230/400 V	DN 50	1450	1,4	1,5	1,1	4,5 - 2,6	400	36
CM 50/1420 T	3 x 230/400 V	DN 50	1450	1,4	1,5	1,1	4,5 - 2,6	400	36
CM 65/420 T	3 x 230/400 V	DN 65	1400	0,4	0,33	0,25	1,5 - 0,9	360	46
CM 65/540 T	3 x 230/400 V	DN 65	1380	0,6	0,5	0,33	1,9 - 1,1	360	46,1
CM 65/660 T	3 x 230/400 V	DN 65	1400	0,8	0,75	0,55	2,6 - 1,5	360	57,9
CM 65/760 T	3 x 230/400 V	DN 65	1390	0,8	0,75	0,55	2,7 - 1,6	360	57,9
CM 65/920 T	3 x 230/400 V	DN 65	1390	1,1	1	0,75	3,6 - 2,1	360	59,7
CM 65/1080 T	3 x 230/400 V	DN 65	1400	1,5	1,5	1,1	5,1 - 3	475	84,3
CM 65/1200 T	3 x 230/400 V	DN 65	1400	1,9	2	1,5	6,4 - 3,7	475	86,9
CM 65/1530 T	3 x 230/400 V	DN 65	1400	2,6	3	2,2	8,8 - 5,1	475	89,6
CM 65/1680 T	3 x 400 V	DN 65	1420	3,2	4	3	6	475	82,2
CM 65/2380 T	3 x 400 V	DN 65	1416	4,7	5,5	4	10	475	105,7
CM 80/550 T	3 x 230/400 V	DN 80	1390	0,8	0,75	0,55	2,7 - 1,6	360	61,3
CM 80/650 T	3 x 230/400 V	DN 80	1396	1,1	1	0,75	3,5 - 2	360	62,8
CM 80/740 T	3 x 230/400 V	DN 80	1400	1,5	1,5	1,1	5,1 - 3	440	90
CM 80/890 T	3 x 230/400 V	DN 80	1400	1,9	2	1,5	6,4 - 3,7	440	94
CM 80/1050 T	3 x 230/400 V	DN 80	1400	3	3	2,2	8,8 - 5,1	440	78,8
CM 80/1530 T	3 x 400 V	DN 80	1400	4	4	3	6	500	125,4
CM 80/1700 T	3 x 400 V	DN 80	1400	5,8	5,5	4	10	500	138,6
CM 80/2410 T	3 x 400 V	DN 80	1420	6,7	7,5	5,5	12,7	620	166,2
CM 80/2700 T	3 x 400 V	DN 80	1450	8,9	10	7,5	16	620	192,4
CM 80/3420 T	3 x 400 V	DN 80	1450	13	15	11	24	620	209,5
CM 100/510 T	3 x 230/400 V	DN 100	1400	1	1	0,75	3,5 - 2	500	99,9
CM 100/650 T	3 x 230/400 V	DN 100	1400	1,5	1,5	1,1	5,1 - 3	500	104,7
CM 100/660 T	3 x 230/400 V	DN 100	1400	1,9	2	1,5	6,4 - 3,7	550	108,8
CM 100/865 T	3 x 230/400 V	DN 100	1400	3	3	2,2	8,8 - 5,1	550	104
CM 100/1020 T	3 x 400 V	DN 100	1400	4	4	3	6	550	109,3
CM 100/1320 T	3 x 400 V	DN 100	1400	5,8	5,5	4	10	550	141
CM 100/1650 T	3 x 400 V	DN 100	1420	6,7	7,5	5,5	12,7	550	162,8
CM 100/2050 T	3 x 400 V	DN 100	1450	8,9	10	7,5	16	670	239,1
CM 100/2550 T	3 x 400 V	DN 100	1450	13	15	11	24	670	242,2
CM 100/3290 T	3 x 400 V	DN 100	1460	17	20	15	31	670	336,6
CM 100/3680 T	3 x 400 V	DN 100	1460	21	25	18,5	38	670	230
CM 100/4100 T	3 x 400 V	DN 100	1460	25	30	22	44	670	330,3
CM 125/1075 T	3 x 400 V	DN 125	1400	5,8	5,5	4	10	620	198,5
CM 125/1270 T	3 x 400 V	DN 125	1420	6,7	7,5	5,5	12,7	620	199,9
CM 125/1560 T	3 x 400 V	DN 125	1450	8,9	10	7,5	16	620	214,9
CM 125/2100 T	3 x 400 V	DN 125	1450	13	15	11	24	800	294,4
CM 125/2550 T	3 x 400 V	DN 125	1460	17	20	15	31	800	350,4
CM 125/3200 T	3 x 400 V	DN 125	1460	21	25	18,5	38	800	379,2
CM 125/3600 T	3 x 400 V	DN 125	1460	25	30	22	44	800	401,3
CM 125/4022 T	3 x 400 V	DN 125	1465	34	40	30	58	800	350,9
CM 150/955 T	3 x 400 V	DN 150	1420	6,7	7,5	5,5	12,7	800	265,5
CM 150/1322 T	3 x 400 V	DN 150	1450	9	10	7,5	16	800	280,6
CM 150/1600 T	3 x 400 V	DN 150	1450	13	15	11	24	800	293,2
CM 150/1950 T	3 x 400 V	DN 150	1460	17	20	15	31	800	343,1
CM 150/2200 T	3 x 400 V	DN 150	1460	21	25	18,5	38	800	357,1
CM 150/2405 T	3 x 400 V	DN 150	1460	25	30	22	44	800	423,5

CP

Aplicaciones: Bomba de circulación para instalaciones de calefacción, refrigeración y agua caliente sanitaria de tipo cerrado o a vaso abierto.

Características constructivas: Cuerpo bomba, soporte motor, tapa ventilador en fundición. turbina en fundición o tecnopolímero según modelos. Sello mecánico en carbón/cerámica.



Eje Rotor en acero inoxidable. Motor IE3 de tipo asíncrono, cerrado y refrigerado a ventilación externa a 2 polos. CONSTRUCCIÓN SEGUN NORMATIVAS CEI. Campo de Prestaciones: e 6 a 420 m³/h hasta 102 mts. Líquido Bombeado: Limpio, sin sustancias sólidas, no viscoso, no cristalizado. Campo de Temperatura del líquido: de -15° C a + 120° C. Máxima Temperatura ambiente: + 40° C. Máxima Presión de Trabajo: 16 bar (1.600 Kpa). Grado de Protección: IP-44 caja bornes IP-55. -Grado de Aislamiento: F.

Tipo Type	Alimentación 50 HZ	BRIDAS	Datos Eléctricos				Entre Ejes mm.	Peso Kg.	
			r.p.m. 1/min.	P1 máx kW	P2 NOMINAL HP	Cons. A			
CP 40/1900 T	3 x 230/400 V	DN 40	2910	1,1	1	0,8	4,5 - 2,6	390	35,3
CP 40/2300 T	3 x 230/400 V	DN 40	2870	1,5	1,5	1,1	5,2 - 3	390	35,8
CP 40/2700 T	3 x 230/400 V	DN 40	2850	1,9	2	1,5	6,4 - 3,7	390	35,1
CP 40/3500 T	3 x 230/400 V	DN 40	2880	2,6	3	2,2	9 - 5,2	390	36,9
CP 40/3800 T	3 x 230/400 V	DN 40	2900	3,6	4	3	11 - 6,4	380	30
CP 40/4700 T	3 x 230/400 V	DN 40	2900	4,9	5,5	4	15,2 - 8,8	380	30
CP 40/5500 T	3 x 400 V	DN 40	2900	6,6	7,5	5,5	11,3	425	39
CP 40/6200 T	3 x 400 V	DN 40	2900	9,2	10	7,5	15,8	425	39
CP 50/2200 T	3 x 230/400 V	DN 50	2870	1,5	1,5	1,1	5 - 2,9	425	38,6
CP 50/2600 T	3 x 230/400 V	DN 50	2860	1,9	2	1,5	6,2 - 3,6	425	38,5
CP 50/3100 T	3 x 230/400 V	DN 50	2870	2,6	3	2,2	9 - 5,2	400	36
CP 50/4100 T	3 x 400 V	DN 50	2910	3,8	5,5	4	7,4	400	36
CP 50/4600 T	3 x 400 V	DN 50	2900	6,6	7,5	5,5	11,3	360	46
CP 50/5100 T	3 x 400 V	DN 50	2900	9,2	10	7,5	15,8	360	46,1
CP 50/5650 T	3 x 400 V	DN 50	2900	9,2	10	7,5	15,8	360	57,9
CP 65/1470 T	3 x 230/400 V	DN 65	2804	2	2	1,5	6,2 - 3,6	360	59,1
CP 65/1900 T	3 x 230/400 V	DN 65	2790	2,6	3	2,2	7,5 - 4,3	360	67,6
CP 65/2280 T	3 x 400 V	DN 65	2856	3,7	4	3	6,5	360	80,6
CP 65/2640 T	3 x 400 V	DN 65	2844	4,9	5,5	4	8,6	360	87,1
CP 65/3400 T	3 x 400 V	DN 65	2870	6,4	7,5	5,5	10,6	360	120,1
CP 65/4100 T	3 x 400 V	DN 65	2906	8,7	10	7,5	14,8	360	123,7
CP 65/4700 T	3 x 400 V	DN 65	2930	12	15	11	21 - 12,2	475	195,8
CP 65/5500 T	3 x 400 V	DN 65	2920	17	20	15	28,8	475	213,8
CP 65/6150 T	3 x 400 V	DN 65	2946	21	25	18,5	34,7	475	230,9
CP 65/7350 T	3 x 400 V	DN 65	2960	24,5	30	22	40,3	475	270,6
CP 65/9250 T	3 x 400 V	DN 65	2955	33	40	30	54,1	475	362,2
CP 80/1400 T	3 x 230/400 V	DN 80	2910	2,5	3	2,2	7,7 - 4,5	360	81,9
CP 80/1700 T	3 x 400 V	DN 80	2845	3,7	4	3	6,8	360	85,7
CP 80/2050 T	3 x 400 V	DN 80	2840	5,3	5,5	4	7,8	360	89,8
CP 80/2400 T	3 x 400 V	DN 80	2870	6,4	7,5	5,5	10,8	360	124,4
CP 80/2770 T	3 x 400 V	DN 80	2913	8,7	10	7,5	14	440	126,8
CP 80/3250 T	3 x 400 V	DN 80	2930	12	15	11	21 - 12,2	440	84,5
CP 80/4000 T	3 x 400 V	DN 80	2920	17	20	15	28,8	440	89,6
CP 80/5150 T	3 x 400 V	DN 80	2946	21	25	18,5	34,7	500	128
CP 80/5650 T	3 x 400 V	DN 80	2960	24	30	22	39,3	500	197,3
CP 80/6850 T	3 x 400 V	DN 80	2955	33	40	30	54,1	500	243
CP 80/8600 T	3 x 400 V	DN 80	2945	42	50	37	70	620	180,4
CP 80/9600 T	3 x 400 V	DN 80	2970	49	60	45	78,2	620	286,6
CP 80/10200 T	3 x 400 V	DN 80	2970	59	75	55	95,9	620	440,1
CP 100/1600 T	3 x 400 V	DN 100	2844	4,9	5,5	4	8,6	500	93,1
CP 100/1950 T	3 x 400 V	DN 100	2870	6,4	7,5	5,5	10,6	500	105,1
CP 100/2350 T	3 x 400 V	DN 100	2906	8,7	10	7,5	14,8	500	97,5
CP 100/2400 T	3 x 400 V	DN 100	2930	12	15	11	21 - 12,2	550	106,6
CP 100/3050 T	3 x 400 V	DN 100	2920	17	20	15	28,8	550	188,1
CP 100/3550 T	3 x 400 V	DN 100	2946	21	25	18,5	34,7	550	218,3
CP 100/3850 T	3 x 400 V	DN 100	2960	24	30	22	39,3	550	189,8
CP 100/4800 T	3 x 400 V	DN 100	2955	33	40	30	54,1	550	200,7
CP 100/5600 T	3 x 400 V	DN 100	2945	42	50	37	70	550	243,1
CP 100/6300 T	3 x 400 V	DN 100	2970	49	60	45	78,2	550	276
CP 100/8300 T	3 x 400 V	DN 100	2970	59	75	55	95,9	670	178,6
CP 125/4750 T	3 x 400 V	DN 125	2945	42	50	37	70	620	268,8
CP 125/5300 T	3 x 400 V	DN 125	2970	49	60	45	78,2	620	280,9
CP 125/5800 T	3 x 400 V	DN 125	2970	59	75	55	95,9	620	288,9

CP

CP - 40

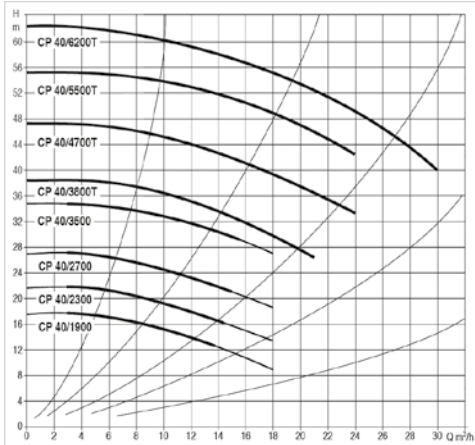

CP - 50

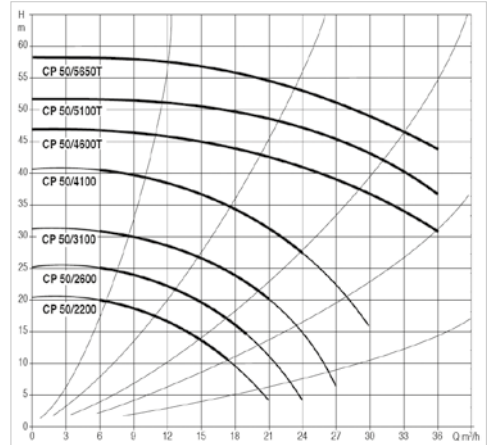

CP - 65

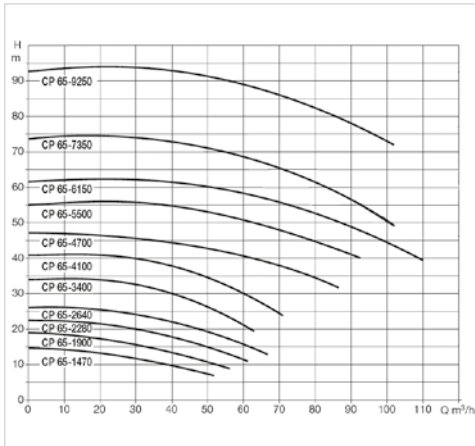

CP - 80

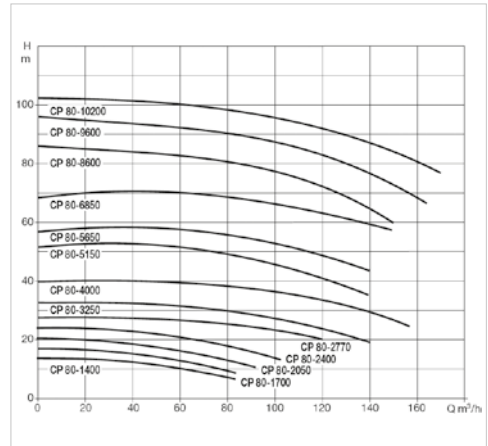

CP - 100

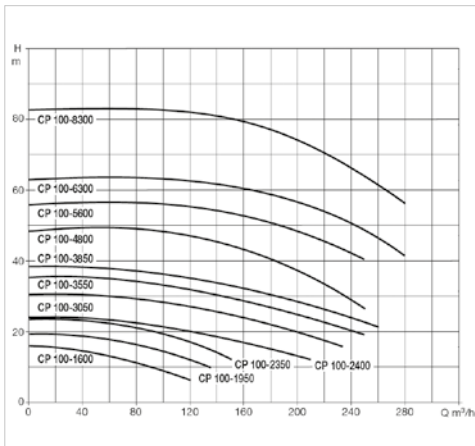

CP - 125

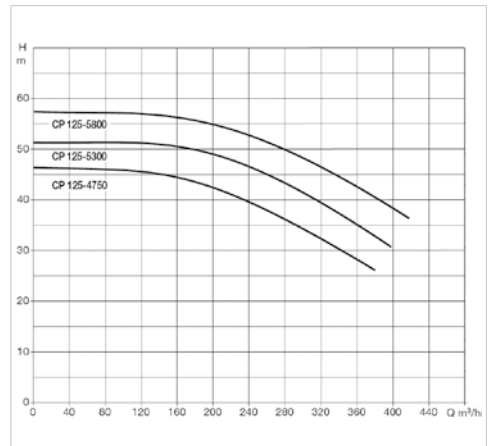



OTROS USOS Y ACCESORIOS

BOMBAS PARA USOS VARIOS		ACCESORIOS DE INSTALACIÓN	
194	BE	199	FILTROS DE CARTUCHO
195	DRILL KIT BE-25 M CONTADOR	200	EVOLUTION
196	MD75	201	AIRMAX
197	GPS - GPC	202	ACCESORIOS
198	HCM	204	PRESSCONTROL MASCONTROL CONTROLPRES

BE

autoaspirante
self-priming



Aplicaciones:

SERIE BE: Electrobomba autoaspirante de anillo líquido. Equipadas con asa, rácores para manguera y cable con clavija de enchufe por su concepción de bomba portátil. **AUTOASPIRANTE HASTA 8 METROS.**

Características constructivas:

Cuerpo bomba, rácores y turbina en bronce según Norma UNI 5075 inoxidable para evitar bloqueos. Eje en acero inoxidable 18/8 y cierre mecánico "Corteco" con muelle de acero inoxidable y elastómero especial.

Temperatura máxima del agua: 35° C

Temperatura máxima ambiente: 35° C

Presión máxima admitida: 6 Kg/cm²

Motor:

Cerrado de ventilación externa, de servicio continuo y grado de protección IP-44.

LA BOMBA ROVER 20 CE PUEDEN SER CON IP-55 PARA TRABAJAR CON GAS-OIL. TODAS LAS BOMBAS SON REVERSIBLES.



Applications:

A liquid ring self-driving pump. Fitted with a handle, connections for hose and cable with plug for its portable facility. The AC versions are with reversible flow with a turn direction switch. **SELF-PRIMMING UP TO 8 METRES.**

Construction:

Pump body, connectors and impeller in stainless bronze according to UNI 5075 to prevent blockage. Shaft in 18/8 stainless steel and "Corteco" mechanical seal with stainless steel spring and special elastomer.

Maximum water temperature: 35° C.

Maximum ambient temperature: 35° C.

Maximum pressure admitted: 6 Kg/cm²

Motor:

Sealed with external ventilation, continuous service and IP-44 protection.

THE ROVER 20 CE PUMP MAY BE WITH IP-55 PROTECTION, FOR WORKING WITH DIESEL.

Tipo Type	Cond. µF	r.p.m.	Voltaje Voltage	Potencia HP KW		Caudal m ³ /h / Flow m ³ /h								Ø Asp. Imp.
						0	0,5	1	1,5	2,4	3,6	4,5	5	
						Altura m.c.a. / Height w.c.m.								
ROVER 20 CE	10	2.900	230	0,5	0,37	25	17	10	2,5					20
BE 25-M	14	1.450		0,6	0,45	12	9,5	7	4,3	0,1				25
ROVER 30 CE	25	2.900	III 400	0,9	0,66	15	13	11,5	9,5	7	3	0,1		30
BE 30-T	-	1.450												
ROVER 40 CE	32	2.900	II 230	1	0,75	15	13,5	12	10,5	7,5	4,7	2	0,4	40
BE 40-T	-	1.450	III 400											

Tipo Type	r.p.m.	Voltaje Voltage C.C.	Potencia W	Caudal m ³ /h / Flow m ³ /h							Ø Asp. Imp.
				0,3	0,6	0,9	1,1	1,25	1,5	1,75	
				Altura m.c.a. / Height w.c.m.							
MARINA 20-12	3.200	12	480	19	17	12	9	5	3	2	20
MARINA 20-24		24									

DRILL

bomba para taladro
drill pump



Aplicaciones:

Electrobomba autoaspirante de anillo líquido adecuada para el trasiego de: **VINO, AGUA DE MAR, ACEITE, GASOIL, etc. APTA PARA ADAPTAR A TALADRO.**

Características constructivas:

Cuerpo bomba, racores y turbina en bronce según norma UNI 5075, inoxidable para evitar bloqueos. Eje en acero inoxidable 18/8 y cierre mecánico " Corteco "



con muelle de acero inoxidable y elastómero especial.

MAXIMA TEMP. AMBIENTE: 40°C.
MAXIMA TEMP. LIQUIDO BOMBEADO: 60°C.
PRESION MAXIMA ADMITIDA: 6 bar.



Applications:

A self-drive liquid ring electropump suitable for transferring WINE, SEA WATER, OIL, DIESEL, etc.

Constructive characteristics:

Pump body, connectors and impeller in bronze according to UNI 5075, stainless steel to prevent blockage. Shaft in 18/8 stainless steel and "Corteco" mechanical seal with stainless steel spring and special elastomer.

MAXIMUM AMBIENT TEMPERATURE: 40° C
MAXIMUM TEMPERATURE PUMPED LIQUID: 60° C
MAXIMUM PRESSURE ADMITTED: 6 bar

Tipo Type	Watts		lts./h. max		Alt. max. m.c.a.		Asp. vert. m.c.a.		Asp. horiz. m.c.a.		Rumorosidad db		Ø Mang. mm.
	1500 r.p.m.	3000 r.p.m.	1500 r.p.m.	3000 r.p.m.	1500 r.p.m.	3000 r.p.m.	1500 r.p.m.	3000 r.p.m.	1500 r.p.m.	3000 r.p.m.	1500 r.p.m.	3000 r.p.m.	
DRILL 20	220	350	720	2100	9	30	2	6	10	40	71	75	20

KIT BE-25 M CONTADOR



Aplicaciones:

Este moderno y actual kit es la solución más adecuada para medir líquidos de uso privado como gasoil, vino, agua dulce y salada, soluciones químicas, leche, etc., cuando se hace necesario garantizar caudales relativamente elevados a presiones relativamente bajas.

Características constructivas:

Kit compuesto por: bomba BE 25-M, Kit impulsión apto para combustibles y líquidos alimentarios, contador de polipropileno con entrada y salida en latón, con contador total y parcial. Presión máxima 3 bar, bancada soporte, filtro de aspiración.

PRECISION: ±5%

KIT VALIDO SOLO PARA USO PRIVADO



Applications:

This modern kit is the best solution for measuring liquids in private use, such as diesel, wine, soft and salt water, chemical solutions, milk, etc...when it is necessary to guarantee relatively high flows at relatively low pressures.

Constructive characteristics:

A kit comprising: BE 25-M pump, drive kit suitable for fuels and food liquids, polypropylene counter with brass inlet and outlet, total and partial counter. Maximum pressure 3 bar. Support bench y suction filter.

PRECISION: ±5%

KIT ONLY SUITABLE FOR PRIVATE USE.



Tipo Type	Tensión Tension	Potencia Power	m³/h	Dimensiones Dimensions
KIT BE-25-Contador	II 230	0,5 CV.	2,7	350 x 200 x 480

MD75

bombas autoaspirantes para gas-oil
self-priming pumps for gas-oil



DIESEL KIT

Compuesto por:
5 metros de manguera hidrocarburos,
pistola graduación caudal (abrir-cerrar)
filtro aspiración



PISTOLA AUTOMÁTICA

Cierra el paso del líquido
cuando el depósito está lleno.
Caudal máximo: 3.600 lts./h.



Aplicaciones:

Electrobomba autoaspirante de anillo líquido, especial para trasiego de gas-oil. Autoaspirante hasta 4 metros, en aspiraciones horizontales de gran longitud es importante instalar una tubería de diámetro superior al de entrada de la bomba.

Características constructivas:

Cuerpo y soporte en fundición gris, con tratamiento anticorrosivo incluso en su superficie interna, turbinas en bronce y cierre mecánico resistente al hidrocarburo y eje en acero inoxidable.

Motor:

Asíncrono, cerrado y de ventilación externa. Protección termo-amperimétrica incorporada y condensador fijo.

Grado de protección IP-55, según normativa vigente para trasiego de gas-oil.

Aislamiento: clase F.

Temperatura máxima del agua: + 50° C

Temperatura máxima ambiente: + 40° C



Applications:

A liquid ring self-driving pump, special for the transfer of diesel fuel. Self-driving up to 4 metres, in long horizontal suction, it is important to install a pipe with a diameter larger than that of the pump inlet.

Construction:

Body and support in grey cast iron with rustproof treatment even on the internal surface, impellers in bronze, mechanical seal resistant to hydrocarbons and shaft in stainless steel.

Motor:

Sealed asynchronous with external ventilation. Built-in thermo-amperimetric protection and fixed capacitor.

IP-55 protection, according with the regulations for diesel transfer.

Insulation: class F.

Maximum water temperature: + 50° C.

Maximum ambient temperature: + 40° C.

Tipo Type	Cond. µF	r.p.m.	A II 230 V	Potencia		Caudal m ³ /h / Flow m ³ /h							Ø Asp. Imp.
				HP	KW	0	0,3	0,6	1,2	1,8	2,4	2,7	
Altura m.c.a. / Height w.c.m.													
MD-75	16	2.900	4,2	0,8	0,59	51	46	41	32	22	12	6	1"

GPS - GPC

equipos de presión para gas-oil
pressure equipment for gas-oil



GPS



Aplicaciones:

Equipos especialmente diseñados para el suministro de gas-oil a calderas de calefacción. En aspiraciones horizontales de gran longitud, instalar tubería de diámetro superior al de la aspiración de la bomba.

Modelo COMPACTO "GPC"

Compuesto por:
Electrobomba MD 75, vaso exp. 5 Lts. hidrocarburos, presostato trabajo y seguridad con rearme manual incorporado, rúcor de 5 vías, manómetro, válvula de retención en aspiración, caja con pilotos de señalización, interruptor puesta en marcha, válvula reductora de caudal y bancada general en chapa doblada.

Modelo SIMPLE "GPS"

Compuesto por:
Electrobomba MD 75, vaso exp. 5 Lts. hidrocarburos, presostato de trabajo, rúcor 5 vías y manómetro



GPC



Applications:

Units specially designed for supplying diesel fuel to the burner. In long horizontal suction, install a pipe with a diameter larger than that of the pump inlet.

GPC COMPACT Model

Comprising:
MD 75 electropump, 5 lts. hydrocarbon expansion tank, working pressure gauge, safety pressure gauge, 5 watt connector, manometer, retention valve in suction, box with warning lights, starting switch, flow reducer valve and general bench in folded plate.

GPS SIMPLE Model

Comprising:
MD 75 electropump, 5 Lts. hydrocarbon expansion tank, working pressure gauge, 5 watt connector and manometer.

Tipo / Type		HP	Voltaje Voltage	"A"	Ø ASP/IMP	Peso Kg.	Caudal l/h.	Presión bar
Simple	Doble							
GPS		0,8	II 230V	4,2	1"	8	600	1-5
GPC		0,8	II 230V	4,2	1"	12	600	1-5

HCM

bombas de arrastre magnético
magnetic drive pumps



Aplicaciones:

Bombas magnéticas monobloc desprovistas de sello mecánico, lo que las hace muy adecuada para la elevación de líquidos agresivos tales como: **ácidos débiles, líquidos corrosivos**. Muy utilizadas para aguas saladas, laboratorios, tratamientos de superficies, soluciones de revelado fotográfico, etc.

Características constructivas:

El principio de funcionamiento de las bombas de arrastre magnético es el de que la transmisión se efectúa a través de la atracción de dos imanes concéntricos y compensados, lo que asegura a través del polipropileno un aislamiento total del líquido a bombear con el motor y el exterior. Todas las partes en contacto con el líquido son de polipropileno excepto los casquillos que son de Rulón-Grafito y las tóricas en Vitón. Eje y arandelas en cerámica.

Motor:

Asíncrono y de ventilación externa, a 2.850 r.p.m. protección IP-44, aislamiento clase F.

MAXIMA TEMP. AMBIENTE: 40° C.

MAXIMA TEMP. LIQUIDO BOMBEADO: 80° C.

VISCOSIDAD MAXIMA: 30 CPS.

DENSIDAD MAXIMA: 1,3

No debe trabajar en seco y no recomendable para líquidos con partículas en suspensión



Applications:

Single block magnetic pumps without a mechanical seal, which makes them highly suitable for raising aggressive liquids such as: **weak acids, corrosive liquids**. Used widely for salt waters, laboratories, surface treatments, photographic developing solutions, etc.

Constructive characteristics:

The working principle of the magnetic drag pumps is that the transmission is developed by the attraction of two concentric, compensated magnets, which, through polypropylene, ensures full insulation of the liquid to be pumped from the motor and the exterior. All parts in contact with the liquid are in polypropylene, excepts for the bushings, which are in Rulon-Graphite and Viton o-rings. Shaft and washers in ceramic.

Motor:

Asynchronous with external ventilation at 2,850 rpm, IP-44 protection, class F insulation.

MAX. AMBIENT TEMPERATURE: 40° C

MAX. TEMP. PUMPED LIQUID: 80° C

MAXIMUM VISCOSITY: 30 CPS

MAXIMUM DENSITY: 1.3

Not for dry working and not recommendable for liquids with suspended particles

Tipo Type	Voltaje Voltage	Watt.	Altura m.c.a. / Height w.c.m.					Ø	
			0	2	4	6	8	ASP.	IMP.
			Caudal m³/h / Flow m³/h						
HCM 75	II 230	100	3,9	3,2	2,1	0,2		3/4"	3/4"
HCM 100	II 230	150	5,4	4,8	4,4	3,6	2,4	1"	1"
HCM 130	II 230	250	6,5	5,9	5,1	4	2	1"	1"

FILTROS DE CARTUCHO



PORTACARTUCHOS	LONGITUD	CONEXIONES
	10"	1"

LOS FILTROS DE CARTUCHO SON GENERALMENTE UTILIZADOS EN EL MARCO DOMÉSTICO E INDUSTRIAL PARA LA ELIMINACIÓN DE PARTÍCULAS EN SUSPENSIÓN Y DE TODOS AQUELLOS SABORES, DEBIDOS A LA EXCESIVA CLORACIÓN DEL AGUA.

CARTRIDGE FILTERS ARE GENERALLY USED IN DOMESTIC AND INDUSTRIAL CIRCUMSTANCES TO ELIMINATE PARTICLES IN SUSPENSION AND ALL UNDESIRED TASTES CAUSED BY EXCESSIVE CHLORINE IN THE WATER.



Portacartuchos:

Están constituidos por materiales atóxicos e idóneos para uso alimentario. Rácor de entrada, salida y purgador en latón. Carcasa transparente para verificar el estado del cartucho.

Cartuchos filtrantes:

Existen diversos tipo de cartuchos, según la necesidad que se requiere.

- 1. Polipropileno bobinado:** cartucho apropiado para uso alimentario, cuya función básica es la de suprimir las partículas en suspensión como arena, óxido, etc.
- 2. Malla lavable:** cartucho apropiado para uso alimentario, cuya función básica es la de suprimir las partículas en suspensión como arena, óxido, etc. Su ventaja principal estriba en que es lavable.
- 3. Carbón activo:** cartucho apropiado para uso alimentario, cuya función básica es la de depurar y declarar las sustancias químicas disueltas en el agua, evitando de esta manera, los olores y sabores producidos por estas.
- 4. Polifosfatos:** el agua en contacto con los polifosfatos sufre un tratamiento que elimina los nefastos efectos de la cal. Es aconsejable su instalación a la salida de descalcificadores.



Cartridge holder:

They are made in atoxic materials ideal for use with foodstuffs. Inlet, outlet and bleeder connections in brass. Transparent housing to check the state of the cartridge.

Filtering cartridges:

There are several types of cartridges, depending on the required needs.

- 1. Reeled polypropylene:** a cartridge suitable for use with foodstuffs, the basic function of which is to eliminate the particles in suspension, such as sand, rust, etc.
- 2. Washable mesh:** a cartridge suitable for use with foodstuffs, the basic function of which is to eliminate particles in suspension, such as sand, rust, etc. The main advantage lies in the fact that it is washable.
- 3. Active carbon:** a cartridge suitable for use with foodstuffs, the basic function of which is to purify and dechlorinate the chemical substances dissolved in the water, thus preventing the smells and tastes caused by them.
- 4. Polyphosphates:** the water in contact with the polyphosphates undergoes a treatment that eliminates the harmful effects of lime. It should be installed on the outlet of decalcifiers.

TIPO / TYPE	CONEXIONES CONEXIONS	FILTRACIÓN FILTRATION	CAUDAL MÁXIMO MAXIMUM FLOW	PRESIÓN MÁXIMA MAXIMUM PRESSURE	TEMPERATURA MÁX. MAX. TEMPERATURE
POLIPROPILENO BOBINADO	1"	50 micras	2,2 m³/h	8 Kg/cm²	45° C
MALLA LAVABLE	1"	60 micras	2,8 m³/h	8 Kg/cm²	45° C
CARBON ACTIVO + P. BOBINADO	1"	10 micras	2,8 m³/h	8 Kg/cm²	45° C
POLIFOSFATOS	1"	-	2,8 m³/h	8 Kg/cm²	45° C

EVOLUTION

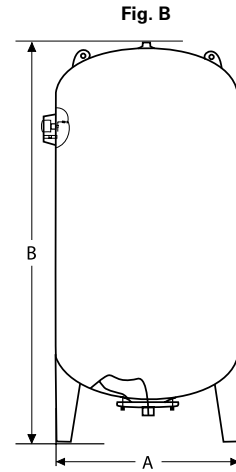
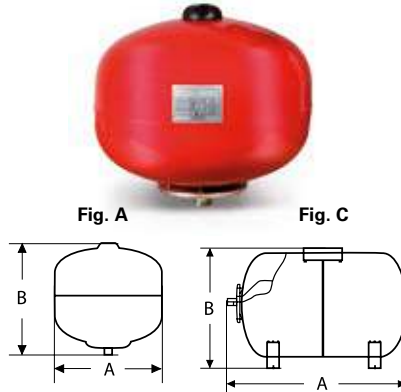
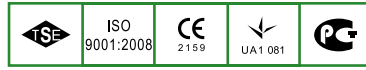

Depósitos de membrana fabricada en EPDM, atóxica e intercambiable, especial para uso alimentario y circuitos de calefacción. Estan construidos en chapa de acero embutido con acabado fosfatado pintado y secado.

Temperatura máxima de servicio: de -5°C hasta 100°C. Los acumuladores de más de 100 litros (incluido) se suministran de serie con manómetro para fácil lectura de la presión. **Bajo demanda pueden suministrarse para presiones de 16 bar o de 25 bar.**



Membrane tanks manufactured with EPDM membrane, non-toxic and interchangeable, especially for food use and hot water circuits. They are constructed of pressed steel, painted with exterior trim drying and phosphate.

Maximum temperature: -5°C to +100°C. All tank with more than 100 liters (included) are supplied, as standard, with pressure gauge for easy pressure reading. **On request can be supplied for pressures of 16 bar or 25 bar.**

Acumuladores Accumulators	Capacidad Capacity	Presión Máxima Max. pressure bar	Dimensiones / Dimensions		Salida Ø Outlet Ø	Figura Figure	Peso Weight	Volumen Volume
			A mm.	B mm.				
EVO 8 EXP	8 lts	10 bar	220	320	1"	A	2,9 Kg.	0,016 m ³
EVO 12 EXP	12 lts		220	380	1"	A	3,8 Kg.	0,018 m ³
EVO 19 EXP	19 lts		280	430	1"	A	4 Kg.	0,034 m ³
EVO 24 EXP	24 lts		360	325	1"	A	4,5 Kg.	0,037 m ³
EVO 35 EXP	35 lts		380	470	1"	A	7,5 Kg.	0,068 m ³
EVO 50 EXP	50 lts		380	560	1"	A	8,5 Kg.	0,081 m ³
EVO 50-16 EXP	50 lts	16 bar	380	580	1"	A	14 Kg.	0,084 m ³
EVO 50 VER	50 lts	10 bar	380	750	1"	B	11 Kg.	0,108 m ³
EVO 80 VER	80 lts		430	960	1"	B	17 Kg.	0,161 m ³
EVO 100 VER	100 lts		460	990	1"	B	18 Kg.	0,209 m ³
EVO 150 VER	150 lts		500	1100	1"	B	29 Kg.	0,280 m ³
EVO 200 VER	200 lts		590	1120	1 1/4"	B	38 Kg.	0,390 m ³
EVO 300 VER	300 lts		640	1230	1 1/4"	B	45 Kg.	0,504 m ³
EVO 500 VER	500 lts		750	1550	1 1/4"	B	75 Kg.	0,872 m ³
EVO 750 VER	750 lts		750	1950	2"	B	110 Kg.	1,248 m ³
EVO 1000 VER	1000 lts		800	2180	2"	B	155 Kg.	1,408 m ³
EVO 1500 VER	1500 lts		960	2380	2"	B	230 Kg.	2,212 m ³
EVO 24 HOR	24 lts	470	280	1"	C	4 Kg.	0,037 m ³	
EVO 50 HOR	50 lts	620	380	1"	C	10,5 Kg.	0,084 m ³	
EVO 80 HOR	80 lts	720	430	1"	C	17 Kg.	0,133 m ³	
EVO 100 HOR	100 lts	800	460	1"	C	23 Kg.	0,169 m ³	

AIRMAX

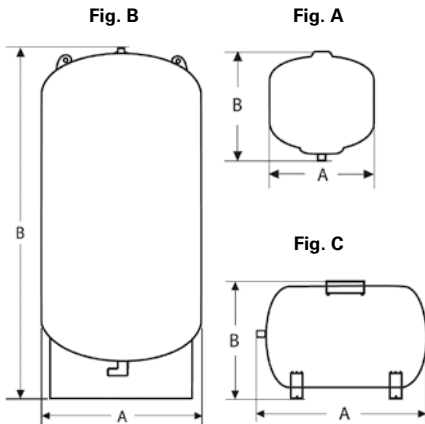

Depósitos de membrana fija para agua potable con certificación para uso alimentario.

Disponen de membrana de diafragma de geometría variable y alto rendimiento según DIN 4807.

Incluye recubrimiento interno rígido en polipropileno que evita el contacto de la membrana con la superficie metálica del depósito.

Conector con la zona de agua en acero inoxidable.

Depósitos certificados según norma PED 2014/68/EU, EN 13831, UPC, NSF58, NSF61, ACS y KC.

Temperatura máxima de servicio: de -10°C hasta 100°C.



Fixed membrane tanks for drinking water with food grade certification.

Includes a diaphragm membrane of variable geometry and high performance according to DIN 4807.

Also includes a rigid internal polypropylene coating that avoids the contact of the membrane with the metal surface of the tank.

Connector with the water area in stainless steel.

Certified tanks according to PED 2014/68 / EU, EN 13831, UPC, NSF58, NSF61, ACS and KC standards.

Maximum temperature: -10°C to +100°C.

Acumuladores <i>Accumulators</i>	Capacidad <i>Capacity</i>	Presión Máxima <i>Max. pressure bar</i>	Dimensiones / <i>Dimensions</i>		Salida Ø <i>Outlet Ø</i>	Figura <i>Figure</i>	Peso <i>Weight</i>	Volumen <i>Volume</i>
			A mm.	B mm.				
AIRMAX 3 EXP	3 lts	10 bar	140	425	1"	A	4,1 Kgs	0,016 m ³
AIRMAX 8 EXP	8 lts		203	425	1"	A	1,9 Kgs	0,018 m ³
AIRMAX 12 EXP	12 lts		229	425	1"	A	2,9 Kgs	0,034 m ³
AIRMAX 18 EXP	18 lts		280	425	1"	A	3,3 Kgs	0,037 m ³
AIRMAX 24 EXP	24 lts		290	425	1"	A	3,9 Kgs	0,068 m ³
AIRMAX 40 EXP	40 lts		290	425	1"	A	5,9 Kgs	0,081 m ³
AIRMAX 60 EXP	60 lts		390	592	1"	A	9,7 Kgs	0,084 m ³
AIRMAX 60 VER	60 lts		390	592	1"	B	9,7 Kgs	0,108 m ³
AIRMAX 80 VER	80 lts		390	770	1"	B	13,1 Kgs	0,161 m ³
AIRMAX 100 VER	100 lts		430	765	1"	B	13,3 Kgs	0,209 m ³
AIRMAX 160 VER	160 lts		550	925	1 1/4"	B	24,5 Kgs	0,280 m ³
AIRMAX 200 VER	200 lts		550	1.060	1 1/4"	B	27,6 Kgs	0,390 m ³
AIRMAX 300 VER	300 lts		550	1.457	1 1/4"	B	41,1 Kgs	0,504 m ³
AIRMAX 450 VER	450 lts		650	1.410	1 1/4"	B	56,5 Kgs	0,872 m ³
AIRMAX 24 HOR	24 lts		415	326	1"	C	4,8 Kgs	1,248 m ³
AIRMAX 60 HOR	60 lts		536	428	1"	C	9,8 Kgs	1,408 m ³
AIRMAX 80 HOR	80 lts		714	428	1"	C	13,1 Kgs	2,212 m ³
AIRMAX 100 HOR	100 lts	690	450	1"	C	13,6 Kgs	0,037 m ³	

ACCESORIOS

VALVULAS DE PIE / Foot Valve								
VAL. RETENCIÓN / Retention Valve	3/4"	1"	1 1/4"	1 1/2"	2"	2 1/2"	3"	4"



VALVULAS PIE
FOOT VALVE



VALVULAS RETENCIÓN
RETENTION VALVE



CAUDALÍMETRO
FLOW METER

Caudalímetro Flow meter	Caudal / Flow max.	Caudal / Flow min.
1 1/2" (50 mm)	21.000	3.000
2" (63 mm)	28.000	6.000
2 1/2" (75mm)	42.000	9.000
3" (90 mm)	51.000	12.000
4" (110 mm)	108.000	36.000
6" (160 mm)	192.000	54.000
8" (200 mm)	306.000	90.000

INTERRUPTOR DE BOYA / SWITCH LEVEL



Incluye 3, 5 o 10 metros
de cable

SACI - 2
LLENADO O VACIADO DE DEPOSITOS

EMPALME TERMORRETRACTIL



LIMITES APLICACION
PARA CABLES

DE Ø 8 A Ø 25

EMPALME DE RESINA



ACCESORIOS

PRESOSTATOS PRESSURE GAUGE



SQUARE D

Tipo	Reg. Kgs/cm ²	Conexión	Descripción
FSG-2	1,4 - 4,6	1/4" Gas	
FYG-22	2,8 - 7		
FYG-32	5,6 - 10,5		
FSG-2/M4	1,4 - 4,6	1/4" Gas	Con dispositivo de seguridad, desconexión a falta de presión de alimentación
FXG-2	1 - 6		INVERSADO
FXG-4	1 - 12		



TELEMECANIQUE

Tipo	Reg. Kgs/cm ²	Conexión
TELEM 6 Kg.	0,9 - 6	1/4" Gas
TELEM 12 Kg.	1,3 - 12	
TELEM 25 Kg.	3,5 - 25	

SACI

Tipo	Reg. Kgs/cm ²	Conexión
SK-2	1,4 - 4,6	1/4" Gas

MANOMETRO / MANOMETER



NORMAL Y GLICERINA
0 - 10 Kg./cm²

Conexión 1/4" Gas

RACOR 5 VIAS 5 WAY FITTING



CIERRES MECANICOS / MECHANICAL SEAL



PRESSCONTROL MASCONTROL CONTROLPRES



Presscontrol



Mascontrol



Controlpress



Aplicaciones: Los controladores de presión **Presscontrol**, **Mascontrol** y **Controlpress** son dispositivos de activación y paro para bombas monofásicas, que gracias al dispositivo electrónico que incorporan en su interior, permiten el arranque y paro automático del motor cuando existe demanda de agua. Gracias a la electrónica y el sensor que incorporan, permiten el paro automático de la bomba cuando se detecta trabajo sin agua.

El **Controlpress** es un sistema de control para electrobombas que, además de las características de los anteriores dispositivos permite la regulación (reducción) de la presión máxima generada por la bomba hasta llegar al valor de presión deseado.

Características constructivas: Grado de Protección IP-65. El Presscontrol, Mascontrol y el Controlpress equipan un pequeño panel en la parte frontal de aparato con indicadores luminosos de:

- Conectado a tensión
- Bomba en marcha
- Fallo (por falta de agua o sobre consumo)

Eliminación del golpe de ariete gracias a un muelle regulador tarado.

Paro automático de la bomba en caso de falta de agua, evitando el funcionamiento en seco, que produciría averías.

Características	PRESSCONTROL	MASCONTROL	CONTROLPRESS
Tensión monofásica / <i>single ph.</i>	230 V.	230 V.	230 V.
Intensidad máxima / <i>max. int.</i>	10 A.	16 A.	16 A.
Frecuencia / <i>Frequency</i>	50-60 Hz.	50-60 Hz.	50-60 Hz.
Campo regulación de la presión	-	-	2,5 - 7 bar
Presión máx. admitida / <i>max. press.</i>	10 bar	10 bar	10 bar
Conexiones / <i>Connections</i>	1"	1 1/4"	1 1/4"
Presión arranque	1,5 bar	1,5 bar	1,5 bar



Applications: The **Presscontrol**, **Masscontrol** and **Controlpress** pressure controllers are start and stop devices for single-phase pumps, which, thanks to the electronic device they incorporate inside, allow the automatic start and stop of the motor when there is a demand for water. Thanks to the electronics and the sensor they incorporate, they allow the automatic stop of the pump when work without water is detected.

Controlpress is an electronic system, that permits the regulation (reducing) of the maximum pressure of the pump.

Constructive characteristics: IP-65 protection. The **Presscontrol**, **Mascontrol** and **Controlpress** have a small panel on the front of the apparatus with light indicators for:

- Turned on
- Pump running
- Failure (empty water or overload)

Elimination of water hammer shock absorber knock by means of a gauged regulator spring.

Automatic pump stop in the event of a lack of water, preventing the dry working that causes breakdowns

USO ADECUADO PARA VIVIENDAS MONO Y PLURIFAMILIARES, BOMBAS SUMERGIBLES PARA POZO RIEGOS DE JARDIN, INDUSTRIAS, CAMPINGS, ETC.

El desnivel desde el aparato hasta el punto más alto de utilización no debe superar los 15 m.c.a. No necesita ninguna regulación ni mantenimiento

THE MAXIMUM HEIGHT TO THE HIGHER POINT OF THE INSTALATION CAN NOT BE HIGHER THAN 15 m.c.a.

DATOS TÉCNICOS

TECHNICAL DATA



CONEXIÓN MOTORES ELÉCTRICOS

ELECTRIC MOTORS CONNECTION

MONOFÁSICO / SINGLE PHASE

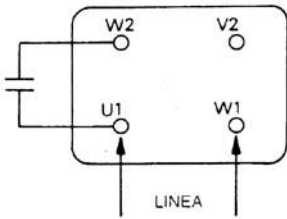
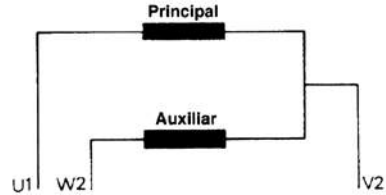
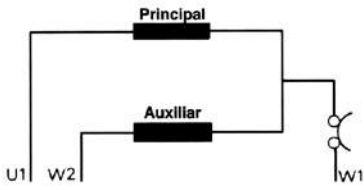

Motoprotector en el bobinado

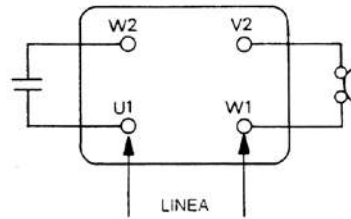

Motoprotector en los bornes

TRIFÁSICO / THREE PHASE

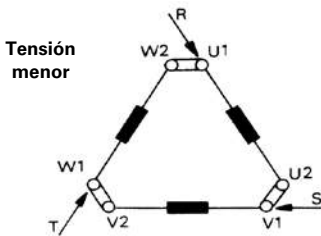

Conexión Triángulo

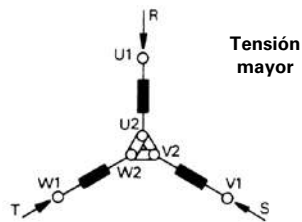
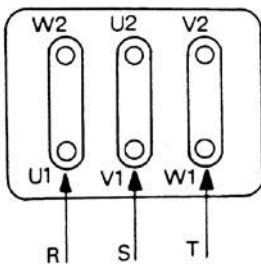

Conexión Estrella

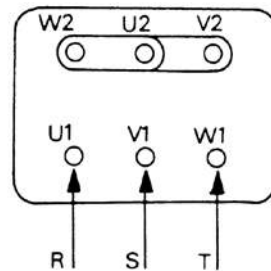

SECCIÓN CABLE MOTOR MONOFÁSICO

SINGLE PHASE MOTOR CABLE SECTION

Potencia / Power		Sección cable mm ² / Cable section mm ²					
CV	KW	1,5	2,5	4	6	10	16
		Longitud / Length					
0,33	0,25	170	280	450	670	1130	1750
0,50	0,37	120	200	320	480	810	1260
0,75	0,55	80	130	220	320	550	850
1	0,75	60	100	170	250	430	670
1,5	1,1	40	70	120	180	300	470
2	1,5	30	60	90	130	230	360
3	2,2	20	40	60	90	150	230

POTENCIA PARA GENERADORES

POWER FOR GENERATORS

Potencia Motor Motor Power		Generador Generator	
HP	KW	KW	KWA
0,5	0,37	1,5	2
0,75	0,55	2	2,5
1	0,75	2,5	3
1,5	1,1	3,5	4,5
2	1,5	4	5
3	2,2	6	7,5
4	3	9	11
5,5	4	10	12,5
7,5	5,5	12,5	15,6
10	7,5	15	18
12,5	9,2	18,8	23,5
15	11	22,5	28
20	15	30	38
25	18,5	40	50
30	22	45	57
40	30	60	75
50	37	75	94
60	45	90	112
70	51	105	131
100	75	150	190
125	92	185	230
150	110	210	260

ESQUEMA CONEXIÓN MONOFÁSICO

SINGLE PHASE SCHEMATIC CONNECTION

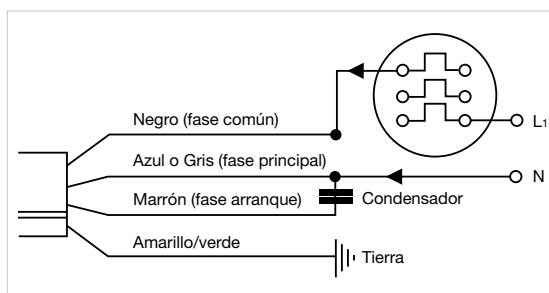

Para cerrar con estanqueidad la conexión de la prolongación del cable, téngase en cuenta el EMPALME RETRÁCTIL.

SECCIÓN CABLE (DIRECTO)

CABLE SECTION (DIRECT)

Arranque Directo / Direct Start													
Potencia / Power		V	Sección cable mm ² / Cable section mm ²										
HP	KW		1,5	2,5	4	6	10	16	25	35	50	70	95
Longitud / Length													
0,5	0,37	230V	176	293									
		400V	524										
0,75	0,55	230V	141	235	377								
		400V	422										
1	0,75	230V	110	183	293								
		400V	328	547									
1,5	1,1	230V	70	117	187	280							
		400V	209	349	558								
2	1,5	230V	53	89	143	214							
		400V	150	266	427								
3	2,2	230V	38	63	101	151							
		400V	113	188	302	452							
4	3	230V	30	50	81	121	200						
		400V	90	151	241	362							
5,5	4	230V	22	37	60	90	150	240					
		400V	67	110	179	269	450						
7,5	5,5	230V		28	45	67	111	180	275				
		400V	50	85	135	195	340	540					
10	7,5	230V		21	34	50	85	135	210				
		400V		64	100	150	255	410					
12,5	9,2	230V			27	41	68	109	155	230			
		400V		50	81	122	205	325	496				
15	11	230V				35	59	93	142	200	230		
		400V			70	105	177	280	430				
17,5	13	230V					51	79	125	172	240		
		400V				90	153	240	375	515			
20	15	230V					44	70	107	148	205		
		400V				78	131	210	320	445			
25	18,5	230V						56	87	120	167	230	
		400V					105	170	261	360	500		
30	22	230V							71	98	136	186	
		400V					89	139	212	294	409		
35	26	230V							64	88	123	168	213
		400V						122	191	264	369	504	
40	30	230V							56	78	109	150	189
		400V						108	170	235	327	448	
50	37	230V								64	89	123	156
		400V							138	190	268	368	468
60	45	230V									76	105	133
		400V							115	160	228	314	398
70	51	230V										92	116
		400V								140	200	275	349
75	55	230V										80	103
		400V								120	175	240	308
90	66	230V											93
		400V									155	220	278
100	75	230V											
		400V										195	248
125	92	230V											
		400V											202
150	110	230V											
		400V											166

SECCIÓN CABLE (ESTRELLA-TRIANGULO)

CABLE SECTION (STAR-DELTA)

Arranque Estrella-Triángulo / <i>Star-Delta Start</i>													
Potencia / Power		V	Sección cable mm ² / Cable section mm ²										
HP	KW		1,5	2,5	4	6	10	16	25	35	50	70	95
		Longitud / Length											
4	3	230V	46	75	122	180							
		400V	136	225	365								
5,5	4	230V	34	56	91	136	235						
		400V	102	168	270	405							
7,5	5,5	230V	25	42	67	100	175						
		400V	76	128	200	300	510						
10	7,5	230V	19	31	50	75	129	203					
		400V	57	93	150	225	385						
12,5	9,2	230V		25	40	60	103	161					
		400V	45	75	120	180	309	483					
15	11	230V		22	35	52	90	141	215				
		400V	39	66	105	156	270	421					
17,5	13	230V		19	30	45	77	121	185				
		400V		57	90	135	230	360					
20	15	230V			26	39	57	104	159	219			
		400V		48	77	116	200	310	475				
25	18,5	230V				31	54	84	128	177			
		400V			63	93	161	251	383	530			
30	22	230V					43	68	103	143	199		
		400V			51	76	129	203	309	428			
35	26	230V					39	61	93	128	179		
		400V			45	68	117	183	279	384			
40	30	230V					54	83	115	159	217		
		400V				60	104	162	248	343	476		
50	37	230V					44	68	94	131	179		
		400V			50	86	132	204	281	392			
60	45	230V						58	80	111	152	192	
		400V					73	112	173	239	332	454	
70	51	230V							51	70	98	133	169
		400V						99	152	210	292	395	505
75	55	230V							62	86	117	149	
		400V						87	133	185	257	350	445
90	66	230V								56	78	106	135
		400V							120	167	233	317	403
100	75	230V								70	95	120	
		400V							108	149	209	284	359
125	92	400V								121	169	230	293
150	110	400V									140	190	242

PÉRDIDAS DE CARGA

LOAD LOSSES

Caudal / Flow m ³ /h		Diámetro interior de tubería en mm / <i>Internal diameter of pipe in mm</i>																								
		25	32	40	50	60	70	80	90	100	125	150	175	200	225	250	275	300	350	400	450	500	600	700		
3	Pc % Vm/s	17 1,7	6 1,03	1,6 0,67	0,54 0,43	0,25 0,29	0,13 0,16	0,06 0,13	0,03 0,1	0,02 0,1																
6	Pc % Vm/s		24 2,06	6 1,34	2 0,85	0,9 0,58	0,43 0,44	0,21 0,32	0,13 0,26	0,08 0,2	0,026 0,2															
9	Pc % Vm/s			20 2,08	7 1,32	3,2 0,89	1,5 0,65	0,75 0,5	0,44 0,39	0,25 0,32	0,15 0,2															
12	Pc % Vm/s				7 2,76	3,2 1,19	1,5 0,88	0,75 0,67	0,44 0,53	0,25 0,43	0,15 0,27	0,06 0,18														
15	Pc % Vm/s					12 2,2	5,2 1,49	2,4 1,1	1,25 0,87	0,7 0,66	0,42 0,54	0,15 0,34	0,06 0,24													
18	Pc % Vm/s						17 2,64	7 1,78	3,5 1,3	1,7 1	0,6 0,78	0,2 0,64	0,08 0,4													
21	Pc % Vm/s							22 3,35	8,8 2,08	4,2 1,54	2,2 1,17	1,3 0,93	0,75 0,75	0,26 0,48	0,1 0,32	0,05 0,24										
24	Pc % Vm/s								12 2,38	5,7 1,76	3 1,34	1,7 1,06	1 0,86	0,36 0,54	0,14 0,36	0,07 0,28										
27	Pc % Vm/s								14 2,7	7 1,97	3,5 1,45	2 1,17	1,25 0,96	0,42 0,6	0,17 0,42	0,08 0,31										
30	Pc % Vm/s								17 2,98	8,2 2,2	4,2 1,74	2,5 1,32	1,5 1,08	0,5 0,68	0,2 0,48	0,09 0,34										
36	Pc % Vm/s								25 3,58	12 2,63	6,3 2	3,5 1,58	2 1,28	0,75 0,82	0,3 0,57	0,14 0,42	0,07 0,32									
42	Pc % Vm/s									16 3,07	8,5 2,34	4,5 1,85	2,7 1,5	0,85 0,96	0,33 0,66	0,18 0,48	0,08 0,37									
48	Pc % Vm/s									21 3,51	10 2,68	6 2,12	3,6 1,72	1,2 1,08	0,45 0,72	0,22 0,56	0,12 0,43	0,06 0,34								
54	Pc % Vm/s									25 3,94	13,5 3	7,6 2,34	4,5 1,92	1,5 1,2	0,55 0,84	0,28 0,63	0,14 0,48	0,08 0,38								
60	Pc % Vm/s									16 3,32	9 2,64	5,5 2,16	1,8 1,36	0,7 0,96	0,33 0,68	0,17 0,53	0,1 0,42									
75	Pc % Vm/s									24 4,17	14 3,31	8 2,68	2,76 1,72	1 1,18	0,49 0,87	0,24 0,67	0,14 0,53	0,08 0,43								
90	Pc % Vm/s										20 3,97	12,5 3,24	3,8 2,04	1,45 1,44	0,74 1,02	0,36 0,8	0,2 0,63	0,14 0,51	0,08 0,42							
105	Pc % Vm/s										26 4,6	16,5 3,74	5,3 2,41	1,95 1,66	0,9 1,22	0,47 0,93	0,27 0,74	0,16 0,59	0,1 0,49							
120	Pc % Vm/s										21,5 4,31	6,9 2,72	2,6 1,93	1,2 1,35	0,61 1,06	0,36 0,84	0,2 0,68	0,14 0,56	0,1 0,47							
135	Pc % Vm/s										26 4,81	9 1,07	3,3 2,13	1,5 1,56	0,76 1,19	0,45 0,95	0,25 0,76	0,17 0,63	0,1 0,53							
150	Pc % Vm/s											11 3,44	4 2,36	1,9 1,74	0,95 1,34	0,55 1,05	0,3 0,086	0,21 0,07	0,12 0,59	0,06 0,43						
165	Pc % Vm/s											13 3,75	4,7 2,61	2,2 1,91	1,13 1,46	0,65 1,15	0,37 0,94	0,24 0,77	0,15 0,65	0,08 0,48						
180	Pc % Vm/s											15,2 4,09	5,5 2,83	2,6 2,08	1,3 1,59	0,76 1,26	0,43 1,02	0,29 0,84	0,18 0,71	0,09 0,52						
210	Pc % Vm/s											21 4,7	7,4 3,32	3,5 2,43	1,8 1,86	0,6 1,49	0,37 1,19	0,24 0,98	0,12 0,82	0,07 0,61	0,06 0,47					
240	Pc % Vm/s											9,4 3,78	4,3 2,77	2,3 2,12	1,3 1,68	0,75 1,36	0,48 1,12	0,3 0,95	0,15 0,69	0,08 0,58						
270	Pc % Vm/s											12 4,26	5,5 3,13	2,8 2,39	2 1,53	1,62 1,26	0,9 1,56	0,58 1,26	0,35 1,07	0,18 0,78	0,09 0,59					
300	Pc % Vm/s											14 4,75	7,5 3,47	3,4 2,66	2 1,71	1,1 1,4	0,74 1,46	0,46 1,18	0,22 0,86	0,11 0,67	0,07 0,53					
360	Pc % Vm/s											9 4,15	4,7 3,17	2,8 2,53	1,6 2,04	1 1,68	0,65 1,41	0,32 1,04	0,16 0,79	0,09 0,63	0,05 0,51					
420	Pc % Vm/s											11,6 4,86	6,2 3,72	3,5 2,94	2 2,37	1,3 1,96	0,82 1,64	0,41 1,22	0,12 0,94	0,07 0,76	0,07 0,59	0,03 0,41				
480	Pc % Vm/s												8,5 4,24	4,9 3,36	2,9 2,72	1,9 2,24	1,2 1,9	0,6 1,38	0,37 1,06	0,29 0,84	0,21 0,69	0,17 0,47	0,04 0,47			
540	Pc % Vm/s												11 4,78	6,5 3,8	3,7 3,06	2,35 2,52	1,52 1,73	0,75 1,56	0,38 1,19	0,22 0,94	0,12 0,76	0,05 0,61				
600	Pc % Vm/s												12,2 5,3	7,4 4,2	4,3 2,81	2,7 2,36	1,7 1,73	0,9 1,34	0,45 1,06	0,25 0,83	0,13 0,61	0,05 0,44	0,02 0,44			
660	Pc % Vm/s												9 4,61	5,2 3,76	3,3 3,07	2,1 2,59	1,1 1,89	0,54 1,46	0,3 1,15	0,16 0,93	0,06 0,65	0,06 0,48				
720	Pc % Vm/s												10 5,05	6 4,08	3,8 3,37	2,5 2,84	1,3 2,08	0,62 1,65	0,35 1,26	0,19 1,02	0,07 0,71	0,07 0,52				
780	Pc % Vm/s													7,3 4,43	4,5 3,65	3 3,08	1,5 2,26	0,75 1,73	0,42 1,36	0,23 1,11	0,09 0,77	0,04 0,56				
840	Pc % Vm/s													8 4,76	5,4 3,95	3,4 3,31	1,7 2,43	0,85 1,86	0,48 1,47	0,26 1,29	0,11 0,83	0,04 0,61				
900	Pc % Vm/s													9 5,1	5,8 4,22	3,75 3,54	1,9 2,6	0,96 2	0,53 1,57	0,29 1,27	0,11 0,88	0,05 0,65				

Las PÉRDIDAS DE CARGA producidas por los accesorios se calculan considerándolos como equivalentes a las siguientes longitudes de tubería:
VÁLVULAS DE PIE: Como 15 m. de tubería
VÁLVULAS DE RETENCIÓN: Como 10 m. de tubería
VÁLVULAS DE COMPUERTA: Como 5 m. de tubería

Para tuberías que no sean de hierro fundido recomendamos multiplicar los valores de las Pérdidas de Carga obtenidos en la tabla por los siguientes coeficientes:
 TUBERÍAS HIERRO FORJADO: 0,76
 TUBERÍAS ACERO SIN SOLDADURA: 0,80
 TUBERÍAS DE FIBRO-CEMENTO: 0,80
 TUBERÍAS DE CEMENTO: 0,80
 TUBERÍAS DE GRES: 1,17
 TUBERÍAS FORJADAS MUY USADAS: 2,10
 TUBERÍAS HIERRO PAREDES RUGOSAS: 3,60

■ Diámetro tubería impulsión recomendable (mm)
 ■ Diámetro tubería aspiración recomendable (mm)V



BARCELONA

C./ Can Muntanyola, 4-22
Pol. Ind. Palou Nord
08401 Granollers, Barcelona - Spain
Tel. +34 93 384 23 51
saci@sacipumps.com

A CORUÑA

Poligono Pocomaco, Parcela D-31
15190 A Coruña - Spain
Tel. +34 981 29 96 88
sacicoruna@sacipumps.com

LEVANTE

C/ Mónaco, Nave 39
Pol. Ind. Ciudad del Transporte II
12006 Castellón de la Plana - Spain
Tel. +34 964 33 44 66
sacilevante@sacipumps.com

www.sacipumps.com

